

# TTL 33-A II

## MODULO ARRAY ATTIVO A 3 VIE

### DESCRIZIONE

Il TTL33-A offre le migliori prestazioni ottenibili da un sistema line array a tre vie. La potenza e la dinamica incredibilmente elevate, l'alta estensione di frequenza, la cura dei dettagli e la compattezza, rendono il TTL33-A lo strumento ideale per l'amplificazione sonora, per i concerti dal vivo e per i grandi eventi.

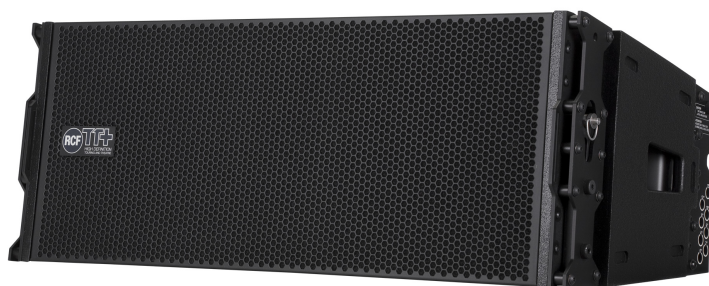

### CARATTERISTICHE

- Amplificatori con alimentazione switching da 1250 Watt
- Ampio angolo di copertura a direttività costante
- 6 trasduttori al neodimio di elevata potenza
- Pannello d'ingresso analogico di alta qualità
- DSP 96 KHz, 32 bit
- Soft limiter e protezione RMS
- Il massimo della potenza disponibile sul mercato in questa dimensione
- RDNet on board

## SPECIFICHE TECNICHE

<b>Specifiche acustiche</b>	Risposta in Frequenza:	60 Hz ÷ 20000 Hz
	Max SPL @ 1m (dB):	135 dB
	Angolo di copertura orizzontale (*):	100°
	Angolo di copertura verticale (*):	15°
<b>Trasduttori</b>	Driver a Compressione:	3 x 1.0" neo, 1.5" v.c
	Midrange:	8" neo, 2.0" v.c
	Woofers:	2 x 8" neo, 2.5" v.c
<b>Sezione Input/Output</b>	Segnale di Ingresso:	bal/unbal
	Connettori in ingresso:	XLR, RDNet Ethercon
	Conessioni di uscita:	XLR, RDNet Ethercon
	Sensibilità di ingresso:	-2 dBu/+4 dBu
<b>Sezione del processore</b>	Frequenze Crossover:	400 Hz - 1800 Hz
	Protezioni:	Thermal, HF
	Limiter:	Fast Limiter
	Controlli:	HF Correction, cluster size, HPF
	RDNet:	Yes
<b>Sezione di potenza</b>	Potenza Totale:	2500 W Peak, 1250 W RMS
	Alte Frequenze:	500 W Peak, 250 W RMS
	Frequenze Mid:	1000 W Peak, 500 W RMS
	Basse frequenze:	1000 W Peak, 500 W RMS
	Raffreddamento:	Convection/Forced
	Conessioni:	Powercon IN/OUT
<b>Conformità agli standard</b>	Marchio CE:	Yes
<b>Specifiche fisiche</b>	Materiale Cabinet/Case:	Baltic birch plywood
	Hardware:	Array side fittings
	Maniglie:	2 on side
	Griglia:	Steel
	Colore:	Black
<b>Dimensioni</b>	Altezza:	290 mm / 11.42 inches
	Larghezza:	760 mm / 29.92 inches
	Profondità:	441 mm / 17.36 inches
	Peso:	33 kg / 72.75 lbs
<b>Informazioni di spedizione</b>	Altezza imballaggio:	395 mm / 15.55 inches
	Larghezza imballaggio:	875 mm / 34.45 inches
	Profondità imballaggio:	545 mm / 21.46 inches
	Peso imballaggio:	37 kg / 81.57 lbs



**CODICE**

• **13000361**

TTL 33-A II

115V

EAN 8024530009748

• **13000360**

TTL 33-A II

220-240V

EAN 8024530009731

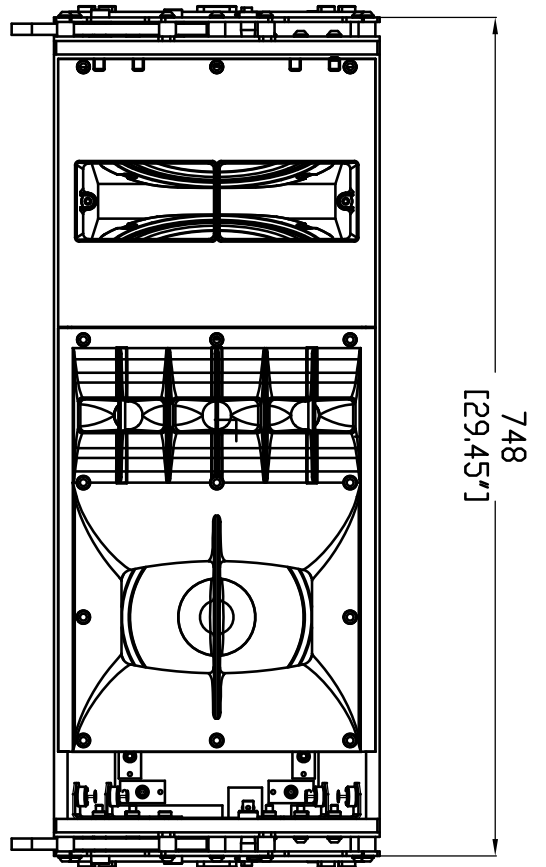
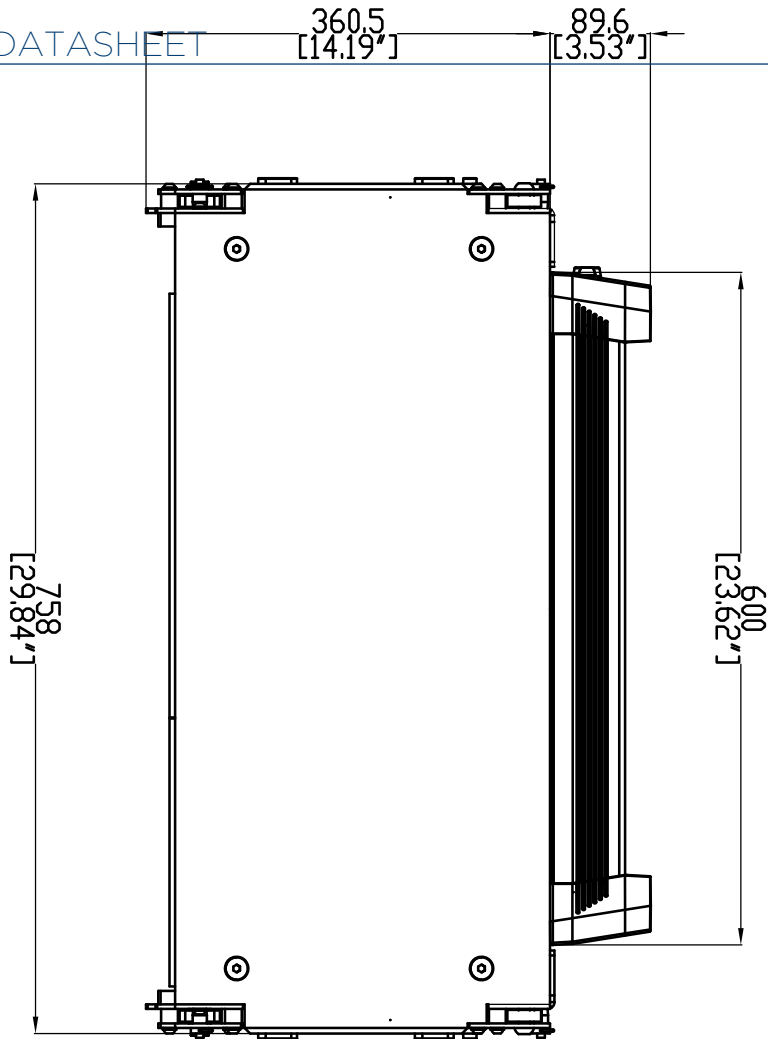

TT33-A

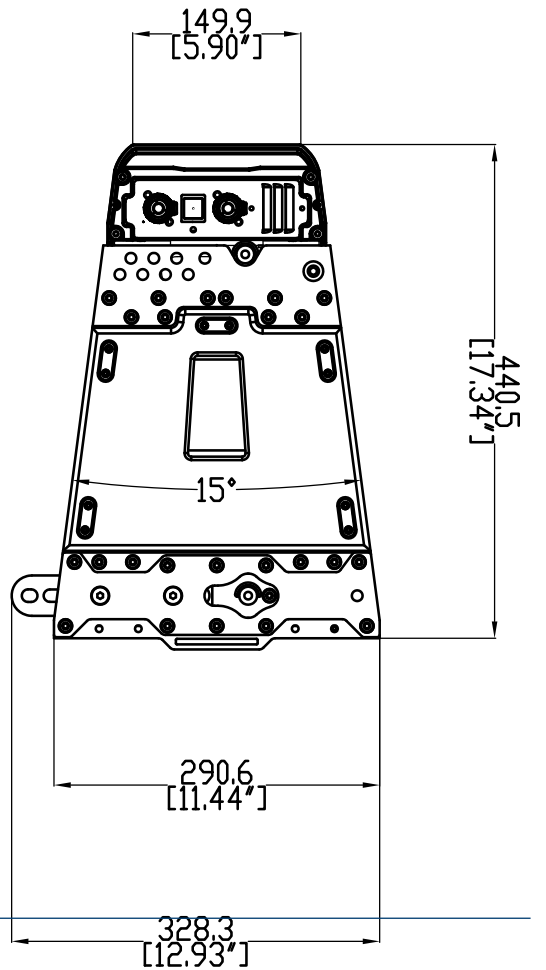

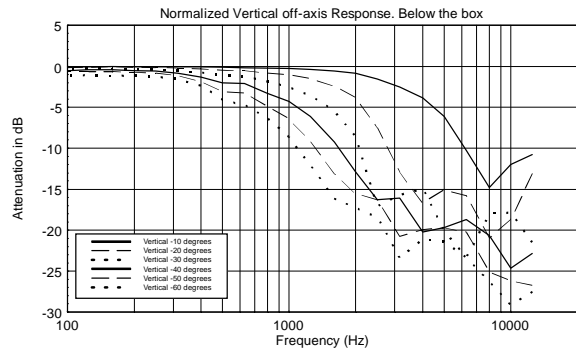
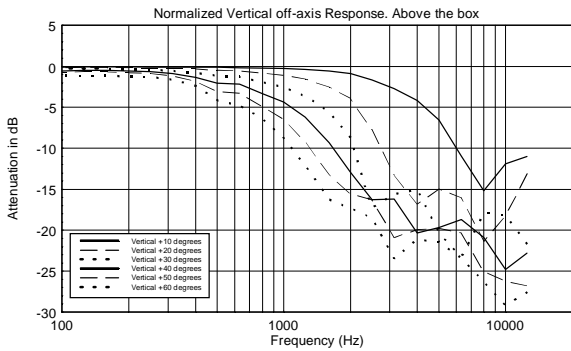
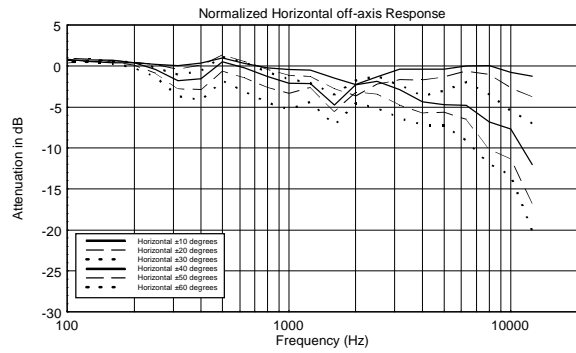
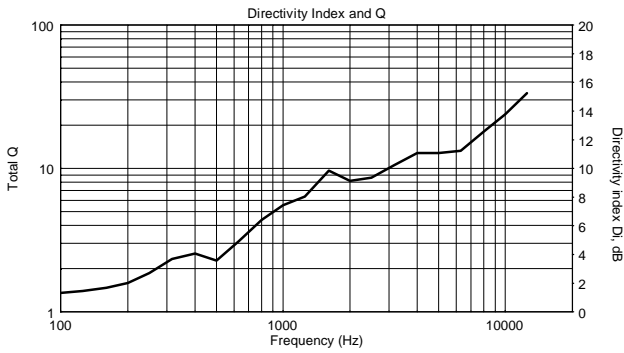
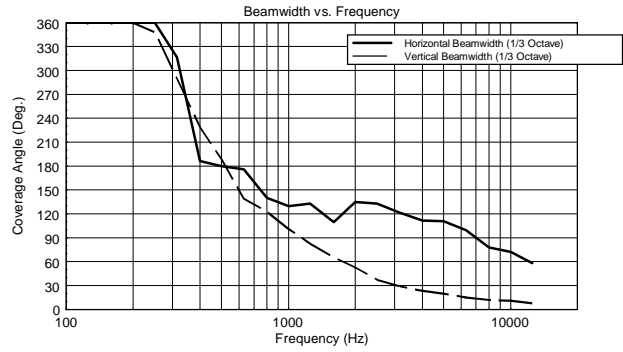
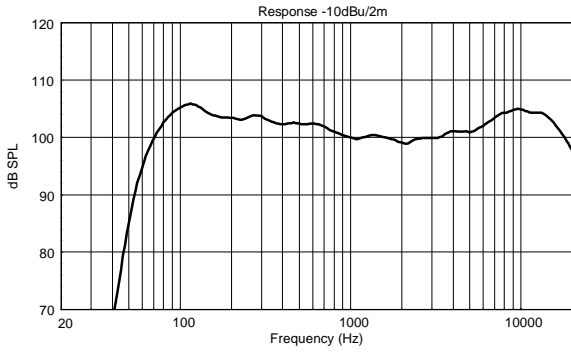

Horizontal 1/3 Octave Polars

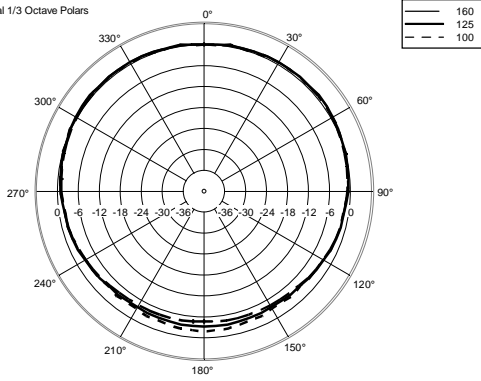

Horizontal 1/3 Octave Polars

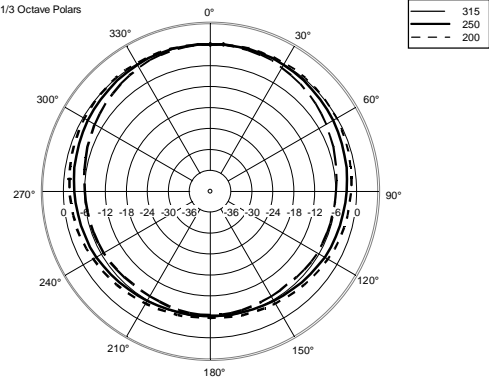

Horizontal 1/3 Octave Polars

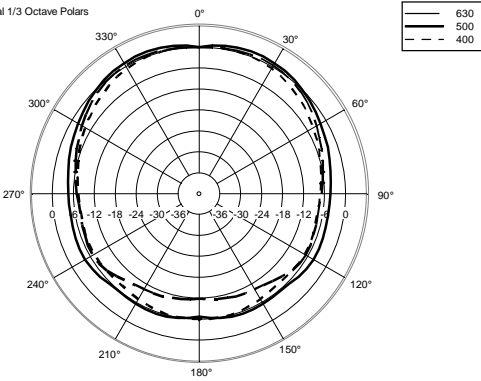

Horizontal 1/3 Octave Polars

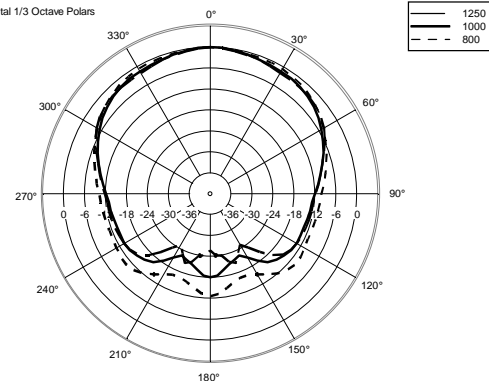

Horizontal 1/3 Octave Polars

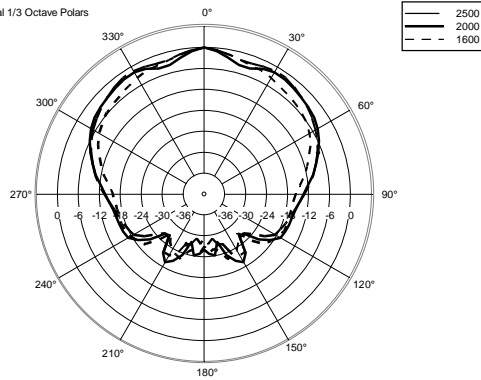

Horizontal 1/3 Octave Polars

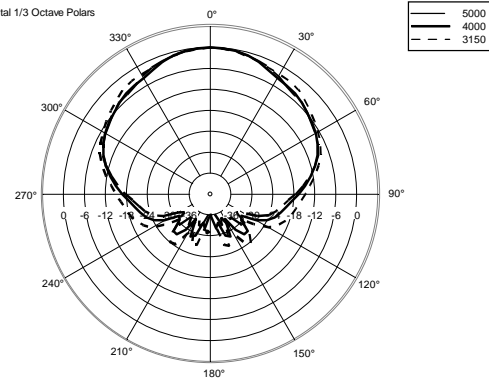

Horizontal 1/3 Octave Polars

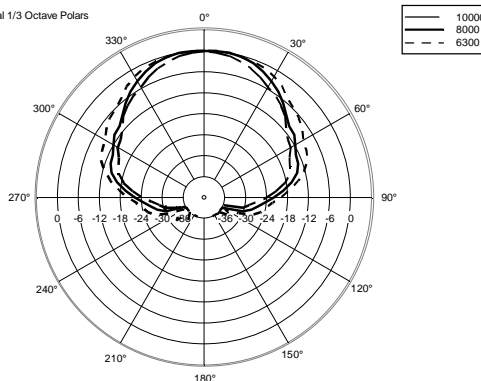

Horizontal One Octave Polars

