

ART 708-A MK II

ACTIVE TWO-WAY SPEAKER



MAIN APPLICATIONS

- Nearfield & portable PA
- Foreground/background PA, distributed PA, frontfill and sidefill
- Houses of worship, performance theatres, theme parks
- Video monitoring, retail, clubs
- Compact voice reinforcement systems
- Stage monitoring

MAIN FEATURES

- 800 W Peak, 400 Watt RMS digital amplifier
- 127 dB max spl
- 90 x 70, Wide dispersion constant directivity horn
- 8" woofer, high power 2.0" voice coil
- 1" HF driver, Mylar dome, 1.5" voice coil
- DSP Processing

DESCRIPTION

The ART 708-A MK II presents high fidelity sound reproduction, careful acoustic design, high quality neodymium transducers, very compact size cabinet and very linear and precise frequency response which is perfect for voice monitoring and amplification.

ART 708-A MK II is equipped with a new generation of 800 Watt Digital Amplifier, 600 Watt for the woofer and 200 Watt for the compression driver. The result of this is very high output, extremely low distortion and an incredible natural sound. The amplifier presents both XLR/jack (Combo) balanced inputs, XLR output link, volume and a switchable EQ Mode (Flat/Boost). The amplifier features a solid mechanical aluminium structure which not only stabilize the amplifier during transportation but also assist in the heat dissipation.

ART 708-A MK II amplifier is mounted on an aluminium plate that integrates the rubber-coated aluminium top handle. This structure design results in a stronger and easy to transport cabinet.

The compression driver uses a 1" throat diameter titanium dome featuring a vented suspension and is powered from a massive high flux magnet and an edge wound 1,5" aluminium voice coil. This top class driver offers a high output, transparent midrange sound and clarity in high frequencies reproduction.

ART 708-A MK II features a 8" inch woofer that, with a 2" inside-outside aluminium coil and a powerful magnetic structure, guarantees a fast and accurate mid-bass frequency range.

The loudspeaker design looks aggressive whilst retaining familiar Art ergonomics and is the result of extensive combined functional and acoustic research.

ART 708-A MK II features two M10 threaded fly points, one at the top one at the bottom, for installation purposes with vertical "U" bracket.

A steel front grille is provided with a special foam on the inside. The amplifier presents both XLR/Jack (combo) balanced inputs and XLR output link.

The back shape of the speaker is ideal also for monitoring, in left or right position.

ACOUSTICAL SPECIFICATIONS

Frequency response:	60 Hz- 20 kHz
Max SPL:	127 dB
Horizontal coverage angle:	90°
Vertical coverage angle:	70°
Compression driver:	1", 1.5" voice coil
Woofer:	8", 2" voice coil

INPUT SECTION

Input signal (Impedance):	bal/unbal
Input/Output connector:	Combo Jack-XLR male / XLR female
Input sensitivity:	-2 dBu / +4 dBu

PROCESSOR SECTION

Crossover frequencies:	1500 Hz
Protections:	RMS
Sensitivity control:	yes
Limiter:	fast limiter
High pass:	-
Controls:	Volume, EQ shape

AMPLIFIER

Total power:	800 W PEAK / 400 W RMS
High frequencies:	200 W PEAK / 100 W RMS
Low frequencies:	600 W PEAK / 300 W RMS
Cooling:	convection/forced
Connection:	VDE AC socket

PHYSICAL

Height:	480 mm (18.8")
Width:	291 mm (11.4")
Depth:	276 mm (10.86")
Weight:	10.2 kg (22.48 lbs)
Cabinet:	Composite PP
Hardware:	-
Handles:	1 on top
Pole mount cap:	yes
Colour:	Black



ART 708-A MK II

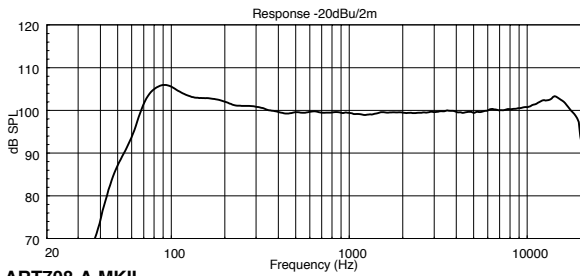

ART708-A MKII

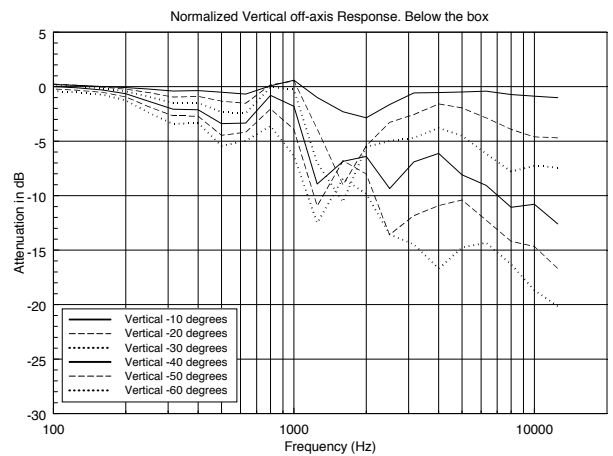
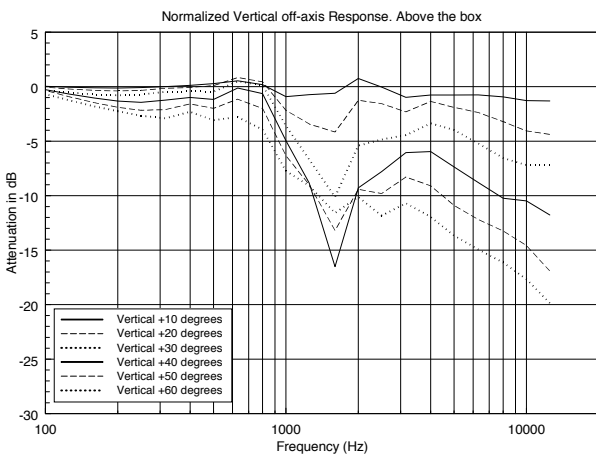
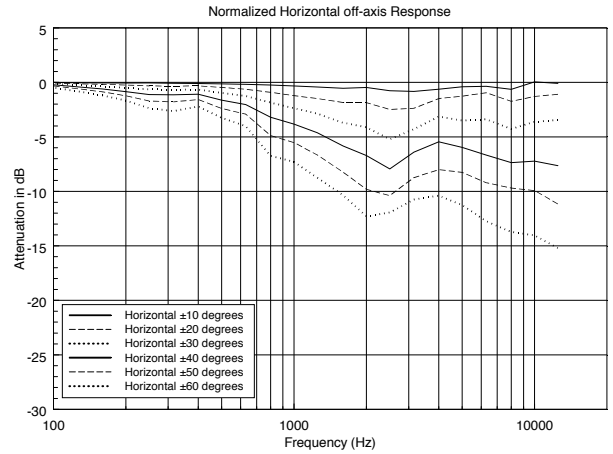
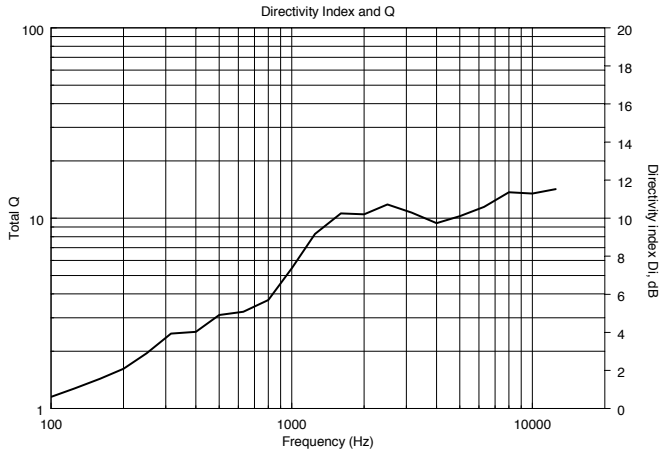
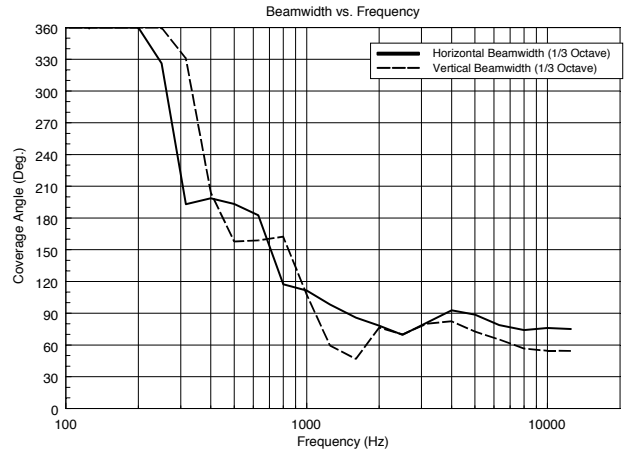

ART 708-A MK II

HORIZONTAL 1/3 POLAR PLOT

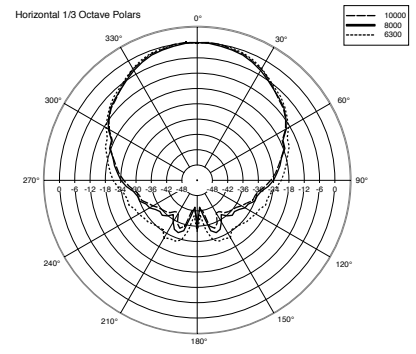
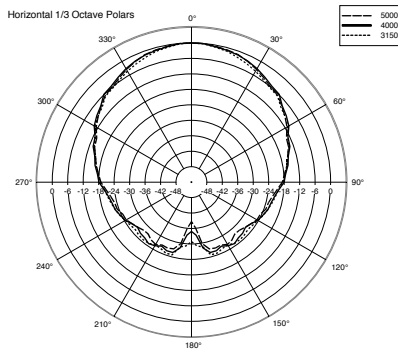
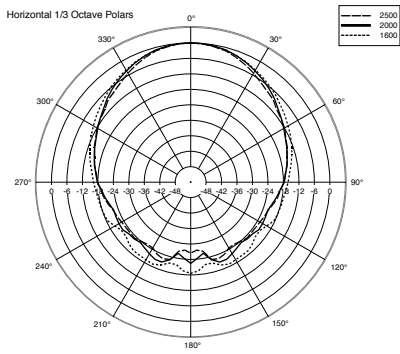
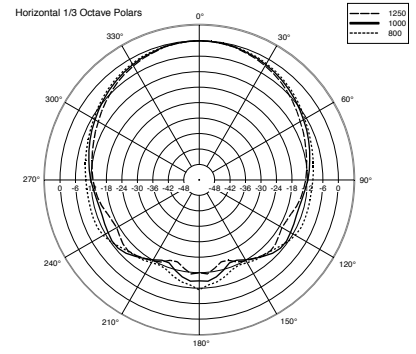
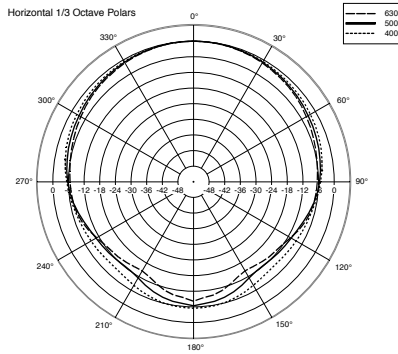
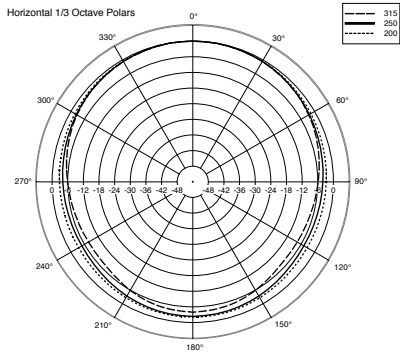

VERTICAL 1/3 POLAR PLOT

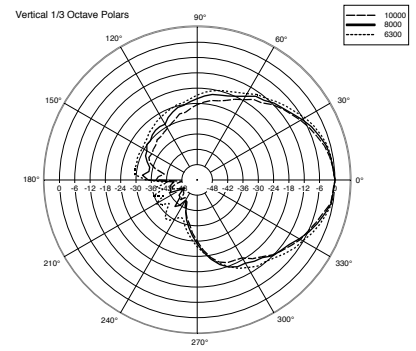
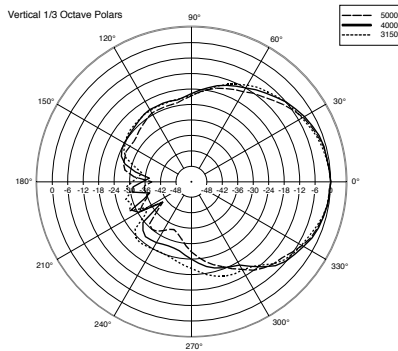
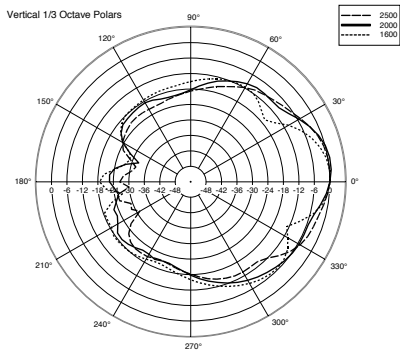
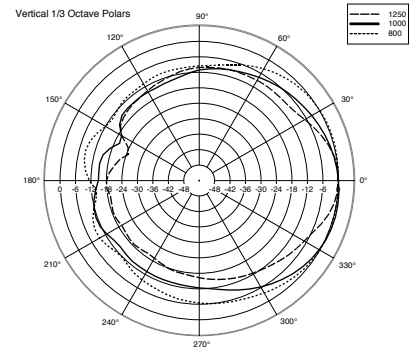
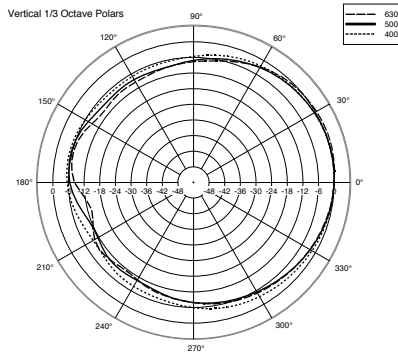
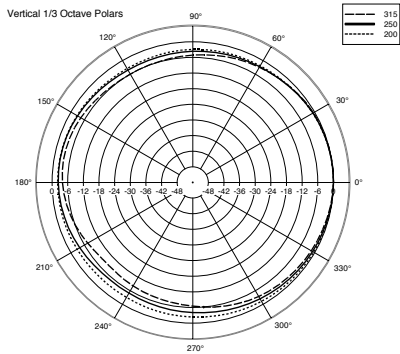

ART 708-A MK II

PART NUMBERS

13000491 - 230 V

13000492 - 115 V

DIMENSIONS (All data are in mm)

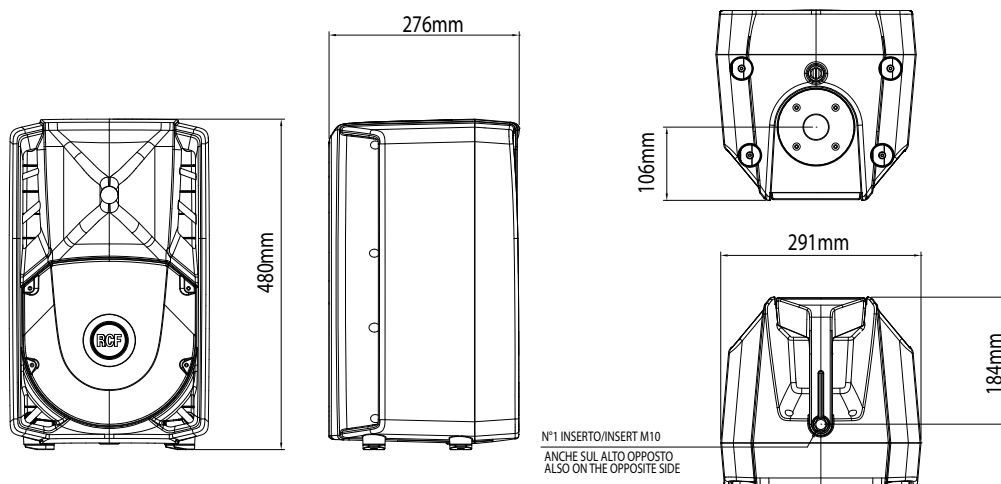

ACCESSORIES

AC PMA	Speaker pole mount.
AC PRO-PM	Steel pole mount accessory for a satellite loudspeaker on a subwoofer. Both ends of the pole mount are fitted with an expanding mandrel system for a tight and vibration-free fit for the base and satellite speakers.
AC PRO-FS	Steel speaker floor stand with folding base and telescopic rod. Tube diameter 35mm. Load capacity up to 50kg.
AC PRO-LF	Steel professional adapter sleeve for loudspeaker stands. Integrated expanding mandrel system which provides a tight and firm fit for the speaker.
AC S140	Aluminum speaker floor stand with folding base and telescopic rod, Tube diameter 35mm.
AC S260	Steel speaker floor stand with folding base and telescopic rod, tube diameter 35mm.
AC EB4X	Kit including no.4 shouldered 10mm eye bolts.
AC PMX	Speaker Pole Mount
ART COVER 708	Protection Cover