

TTL 33-A II

AKTIVES 3-WEGE LINE ARRAY MODUL

BESCHREIBUNG

Unsere Spitzentechnologie, Wissen, Erfahrungen und kontinuierliche Entwicklung brachte uns zu einem einzigartigen Ergebnis: das TTL33-A. Ein aktives, ultra kompaktes Linearray mit einer breiten horizontalen Abstrahlcharakteristik das einen neuen Standard für Touring und Theater Beschallungssystemen setzt.

Das TTL33-A bietet höchste Performance eines „Small-Size“ 3-Wege Line Array Moduls. Die bemerkenswerte hohe Ausgangsleistung und Dynamik, die extreme Genauigkeit und die Ausdehnung des Hochtonbereiches in Verbindung mit der kompakten Größe machen das TTL33-A zum idealen Werkzeug für Beschallungen im Freien, Live-Veranstaltungen und Events

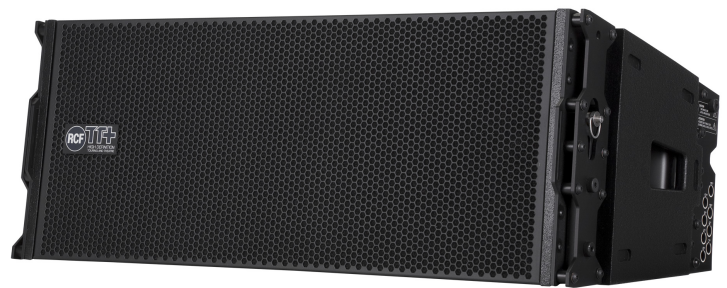

FUNKTIONEN

- 1250 W Schaltnetzteil-Endstufe
- breite und konstante Abstrahlung
- 6 High Power Neodym- Lautsprecher
- Hochwertige analoge Eingangstufe
- 96 kHz, 32 bit DSP
- Soft Limiter und RMS Limiter
- Maximaler Output bei geringer Größe
- RDNet on board

SPEZIFIKATIONEN

Spezifikation	Frequenzgang:	60 Hz ÷ 20000 Hz
	Max SPL @ 1m (dB):	135 dB
	Horizontaler Abstrahlwinkel (°):	100°
	Vertikaler Abstrahlwinkel (°):	15°
Schallwandler	Kompressionstreiber:	3 x 1.0" neo, 1.5" v.c
	Mittbereich:	8" neo, 2.0" v.c
	Woofer:	2 x 8" neo, 2.5" v.c
Input/Output Sektion	Eingangssignal:	bal/unbal
	Eingangsbuchsen:	XLR, RDNet Ethercon
	Ausgangsanschlüsse:	XLR, RDNet Ethercon
	Eingangsempfindlichkeit:	-2 dBu/+4 dBu
Prozessor	Übergangsfrequenz:	400 Hz - 1800 Hz
	Schutzschaltungen:	Thermal, HF
	Limitier:	Fast Limiter
	Steuerung:	HF Correction, cluster size, HPF
	RDNet:	Yes
Power Section	Gesamtleistung:	2500 W Peak, 1250 W RMS
	HF Bereich:	500 W Peak, 250 W RMS
	Mitten-Frequenzen:	1000 W Peak, 500 W RMS
	Tiefe Frequenzen:	1000 W Peak, 500 W RMS
	Kühlung:	Convection/Forced
	Verbindungen:	Powercon IN/OUT
Standardkonformität	CE Zeichen:	Yes
Physikalische Daten	Gehäuse Material:	Baltic birch plywood
	Hardware:	Array side fittings
	Griffe:	2 on side
	Gitter:	Steel
	Farbe:	Black
Größe	Höhe:	290 mm / 11.42 inches
	Breite:	760 mm / 29.92 inches
	Tiefe:	441 mm / 17.36 inches
	Gewicht:	33 kg / 72.75 lbs
Versandinformationen	Verpackung Höhe:	395 mm / 15.55 inches
	Verpackung Breite:	875 mm / 34.45 inches
	Verpackung Tiefe:	545 mm / 21.46 inches
	Verpackungsgewicht:	37 kg / 81.57 lbs



ARTIKEL-NUMMER

• **13000361**

TTL 33-A II

115V

EAN 8024530009748

• **13000360**

TTL 33-A II

220-240V

EAN 8024530009731

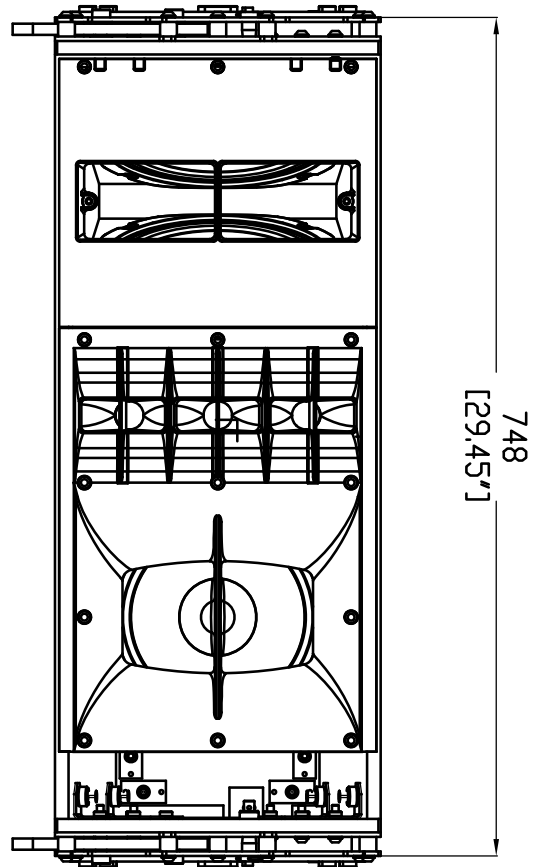
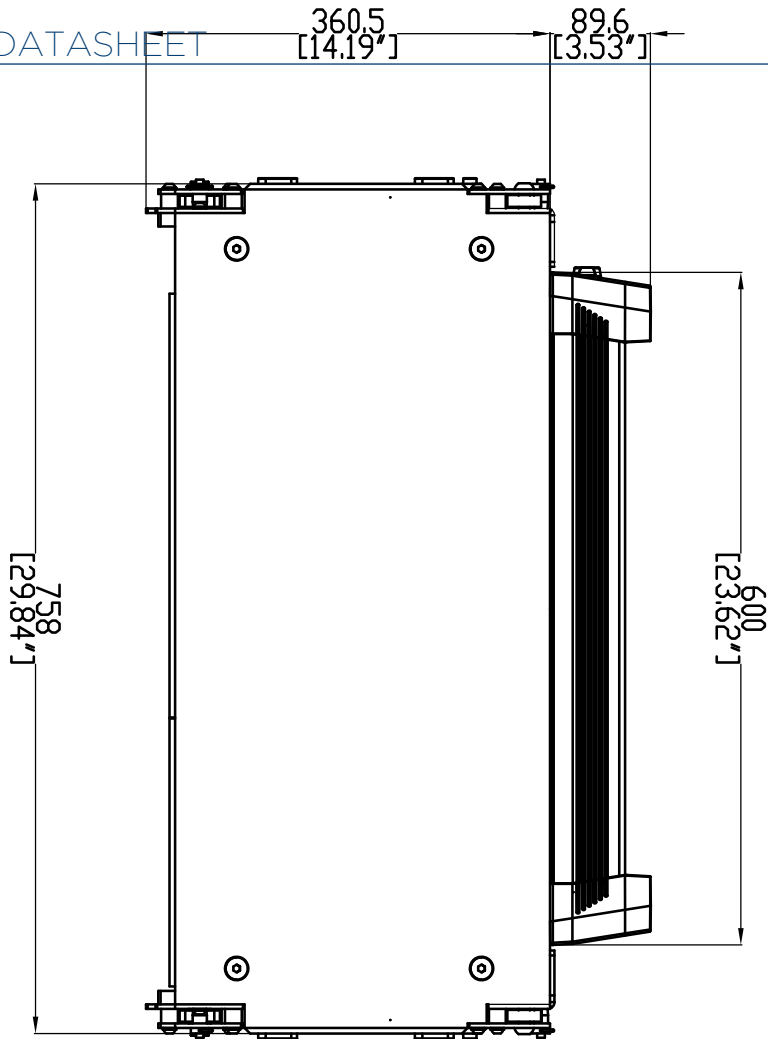

TT33-A

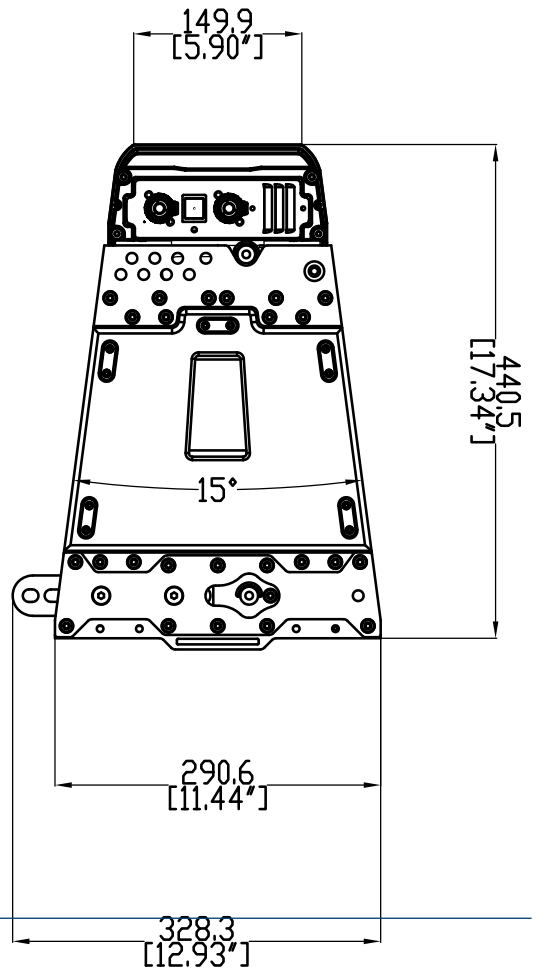

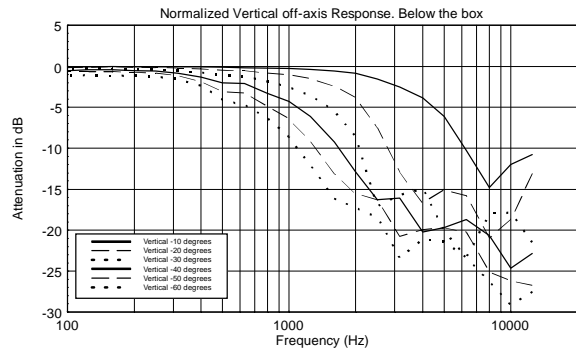
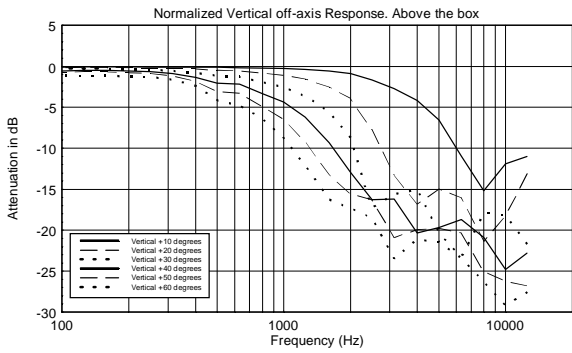
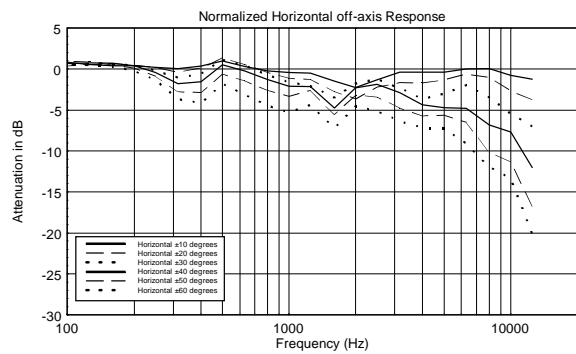
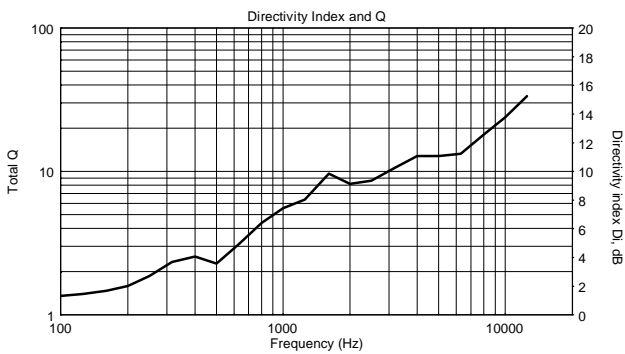
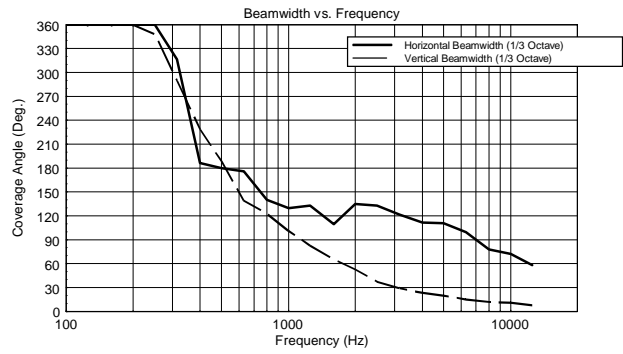
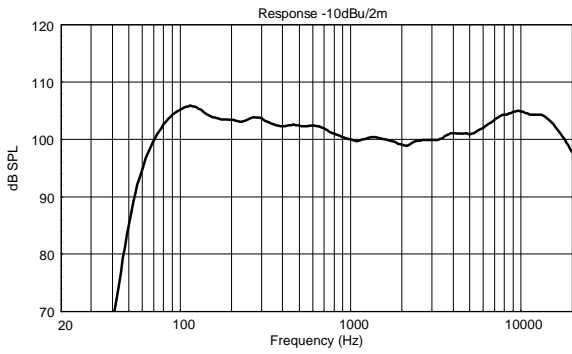

Horizontal 1/3 Octave Polars

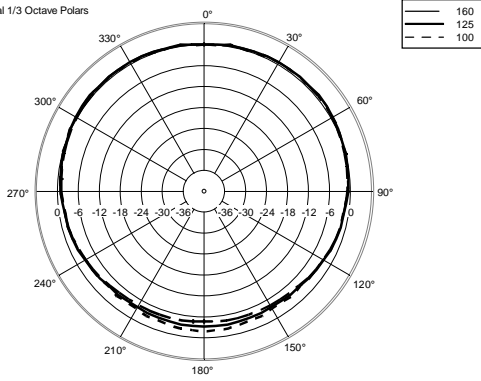

Horizontal 1/3 Octave Polars

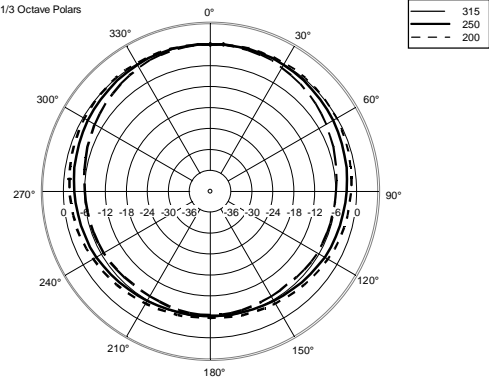

Horizontal 1/3 Octave Polars

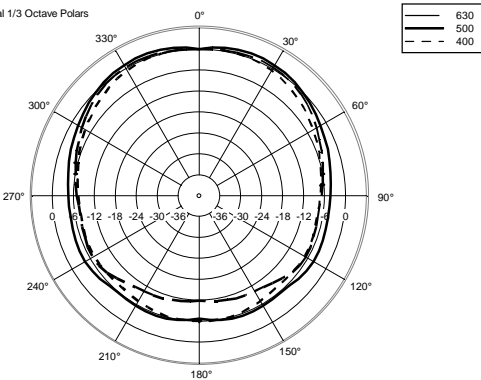

Horizontal 1/3 Octave Polars

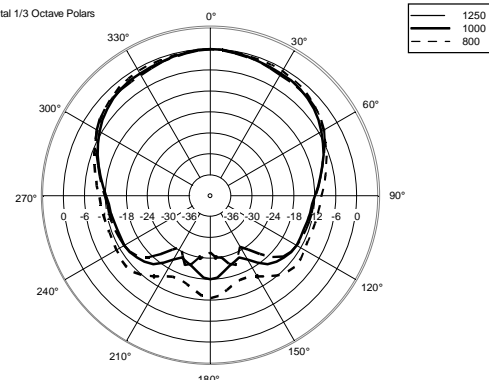

Horizontal 1/3 Octave Polars

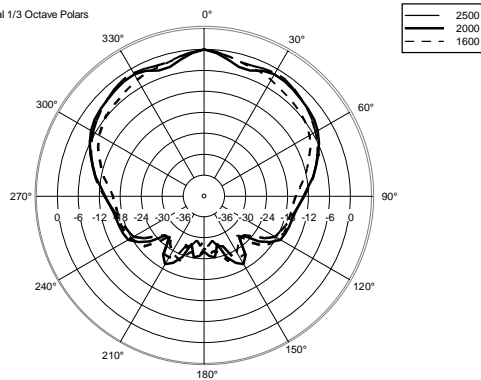

Horizontal 1/3 Octave Polars

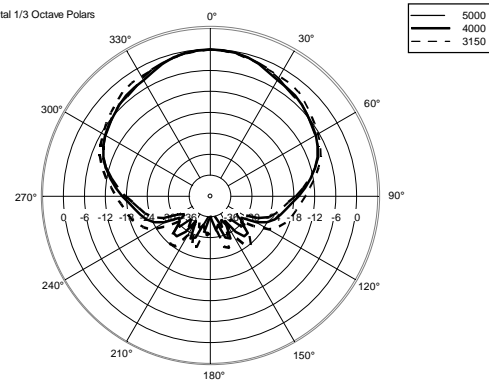

Horizontal 1/3 Octave Polars

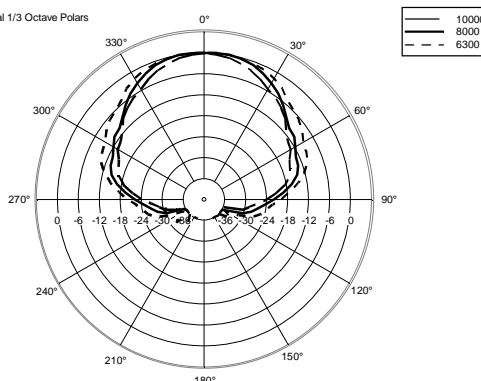

Horizontal One Octave Polars

