

ARTSERIES



ACTIVE SPEAKER

ART 312A MKIII

RCF ART 312-A is an active, wide dispersion 2 way sound reinforcement speaker.

It integrates a digital high power 400 Watt amplifier, a multiway DSP section and premium RCF low distortion, high power transducers. The result is compact, high power accurate systems, unique in there class for clarity and low distortion.

The total amplifier power is 400 watt RMS: a 300 watt digital amplifier design is used to power the low frequencies, the compression driver is powered from 100 watt of digital clear power.

The Dsp takes care of low noise crossover, equalisations, soft-limiters, rms limiters, large signals compression and protection functions.

The input section presents a XLR input connector that is switchable from microphone to line levels. A master volume control and a useful XLR loop through link guarantee the best versatility.

The new 12" inch woofer is the result of the latest refinement in years of RCF experience in compact 2 way speakers, resulting in a fast and accurate reproduction of the midbass frequency range and controlled deep bass. The compression driver uses a new 1.5" mylar dome in front of a low compression, optimised geometry and radial phase plug. This innovative design is powered from a high flux ferrite magnet and offers a very open and natural midrange sound and extreme precision in high frequencies reproduction.

All the system is housed in a strong , very lightweight, polypropylene composite enclosure . The woofer is protected from a strong, powder coated, metal grille. The cabinet features 2 M10 threaded fly points, a 35 mm stand adaptor plus an ergonomic top handle for easy transportation.

Applications

ART 312-A is the optimum choice for live sound situations where an exceptional full range, outstanding bass reproduction and accurate high frequency delivery is required. The ART 312-A is also suitable for monitoring applications.

Features

- 400 watt Monolithic bi-amplification, 300 watt low frequency and 100 watt high frequency power
- 128 dB max SPL
- Wide dispersion, 90 x 60 low distortion, constant directivity horn
- 12" high power woofer, 2.5" voice coil
- 1", mylar dome, high frequency driver
- Electronic equalization, phase alignment, limiter and protection
- Jack/XLR input, XLR signal output
- 2 side handles and 1 comfort designed top handle for easy transportation and positioning
- Four M10 fly points and built in pole mount adaptor

ACOUSTICAL SPECIFICATIONS

Frequency response:	45 - 20 KHz
Max SPL:	128 dB
Coverage angle:	90° x 60°
Compression driver:	1"
Woofer:	12"

INPUT SECTION

Input signal (Impedance):	bal/unbal
Input connector:	jack/xlr
Output signal connector:	xlr
Input sensitivity:	-2 dBu / +4 dBu

PROCESSOR SECTION

Crossover frequencies:	1700 Hz
Protections:	Thermal, RMS
Limiter:	Fast limiter
Controls:	Volume, EQ Shape, Mic/Line

AMPLIFIER

Nominal power:	400 Watt
High frequencies:	100 Watt
Low frequencies:	300 Watt
Cooling:	Convection

PHYSICAL

Cabinet:	Composite PP
Dimensions (HxWxD):	26.77" x 15.94" x 13.58" (680x405x345 mm)
Weight:	38.28 lbs. (17.4 kg)
Hardware:	4 M10 flying points
Handles:	2 side, 1 top
Pole Mount / Cap:	yes
Colour:	Black

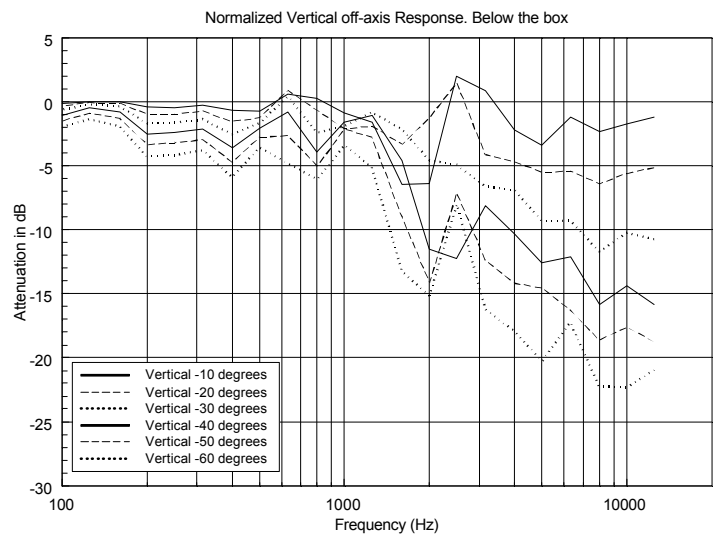
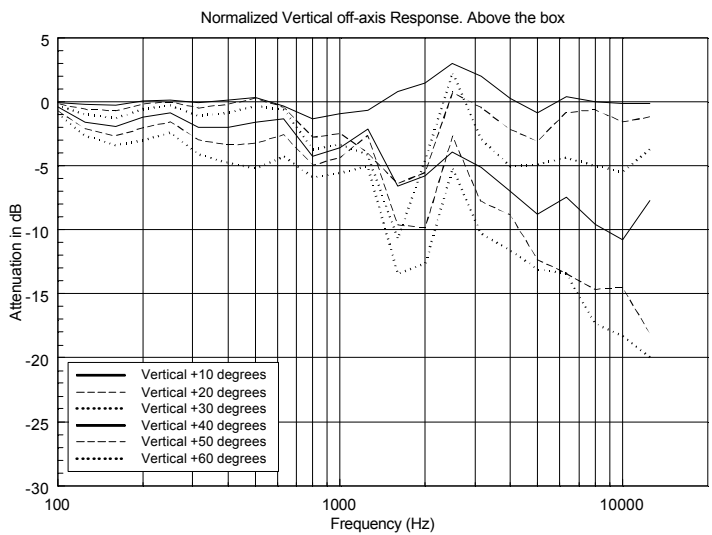
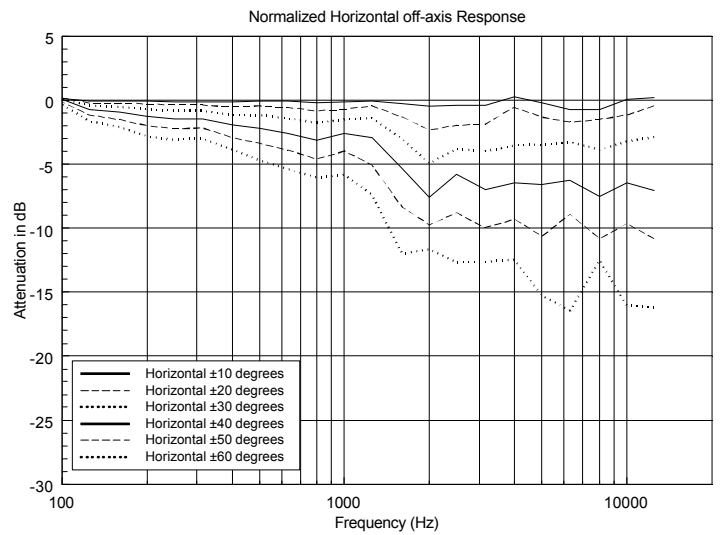
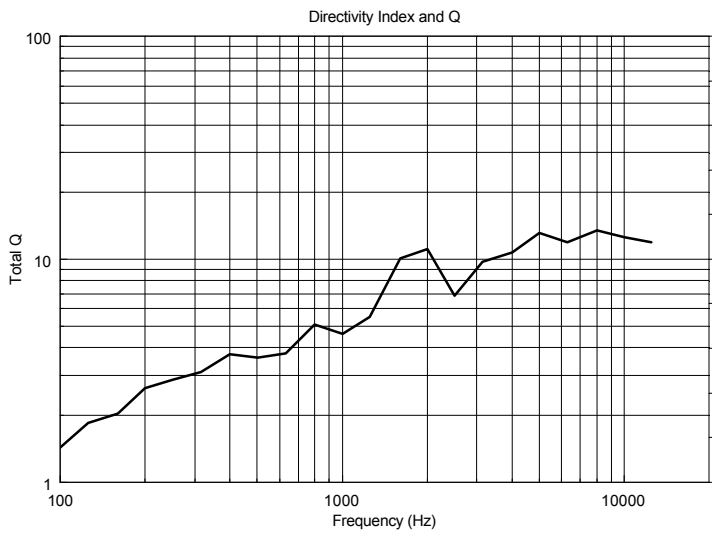
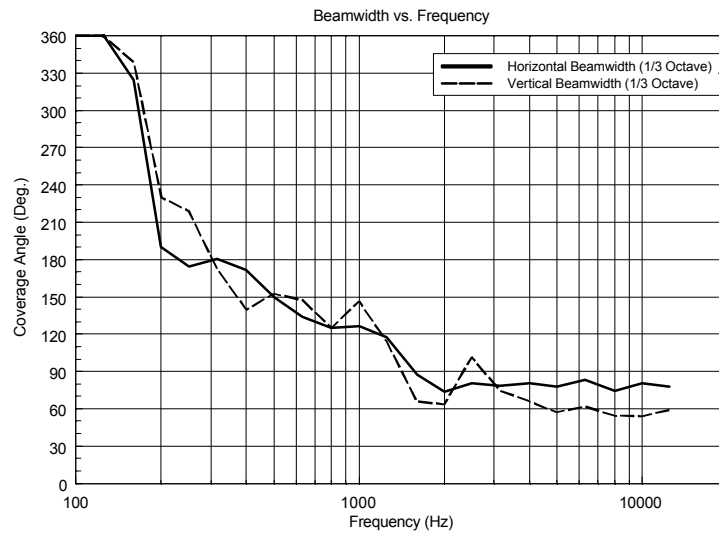
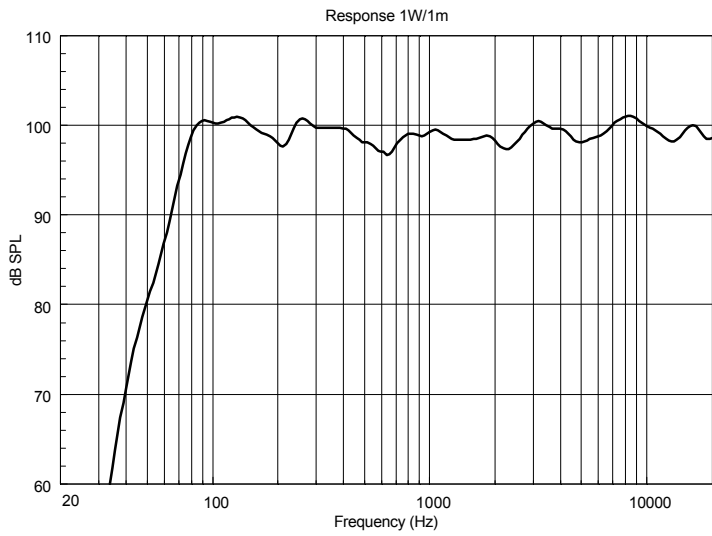



Horizontal 1/3 Polar Plot

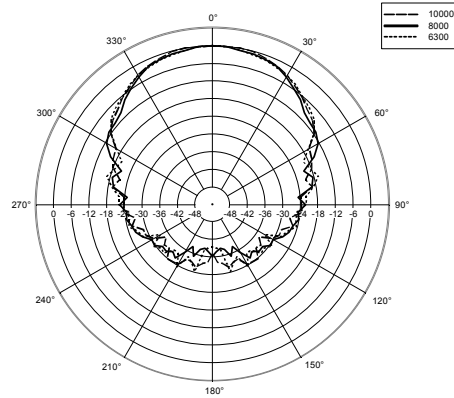
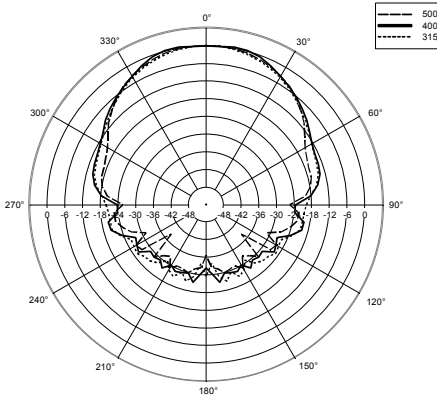
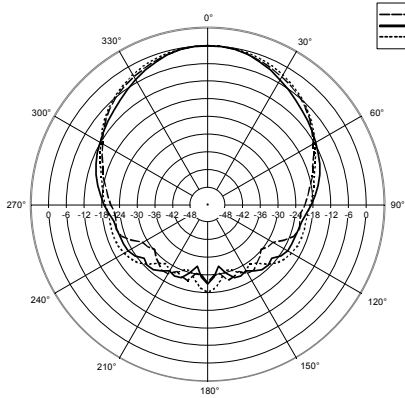
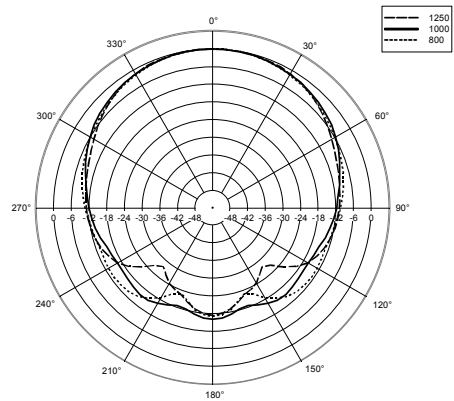
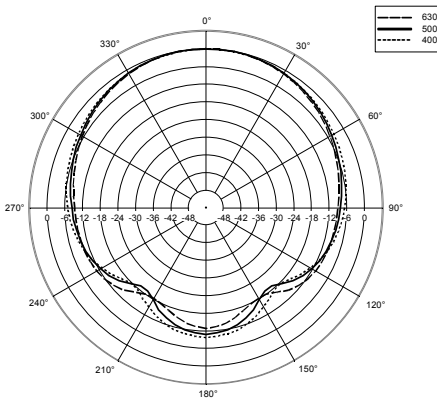
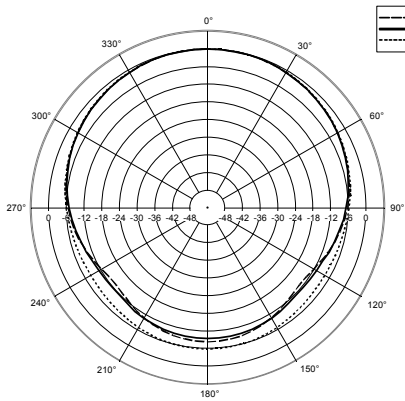

Vertical 1/3 Polar Plot

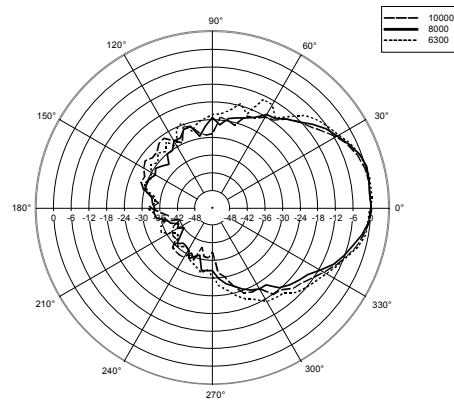
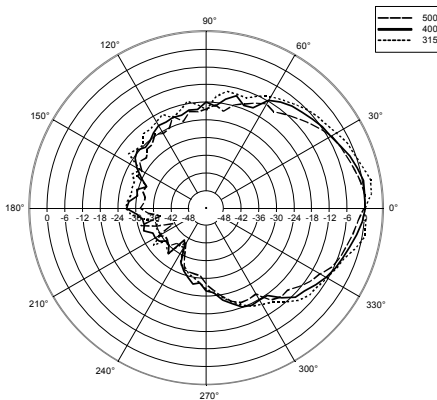
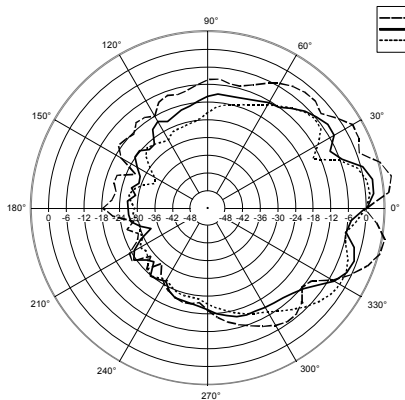
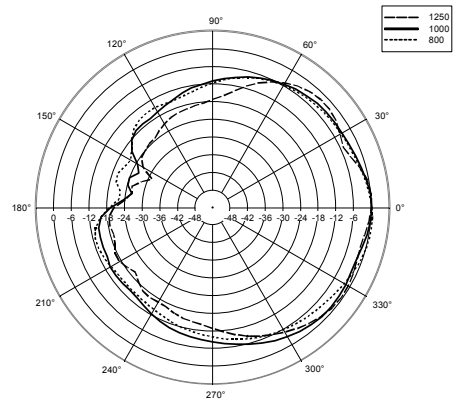
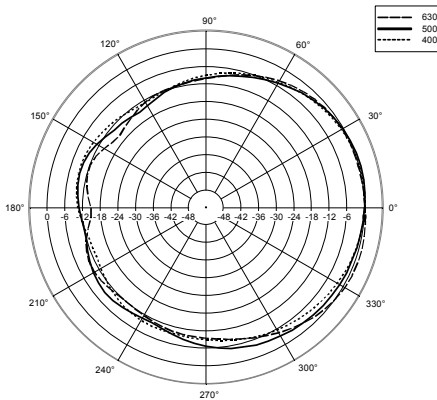
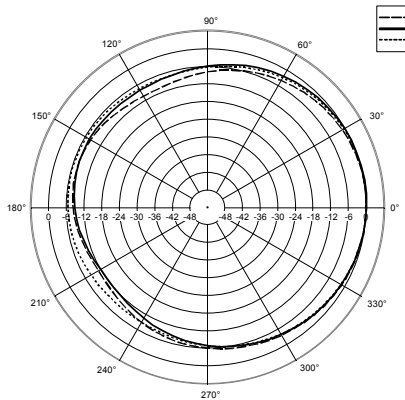

CSI PRODUCT SPECIFICATIONS FOR DESIGNERS, SPECIFIERS, AND CONSULTANTS (ALSO KNOWN AS “A&E SPECIFICATIONS”) The following are “Part 2 Products” CSI-type specifications. It is assumed that “Part 1 General – Administrative and Procedures” and “Part 3 Execution – Installation and Maintenance” are part of an overall audio system or project specification.
PART 2 PRODUCTS

2.01 Approved Manufacturer/Product

A. RCF, Via Raffaello 13, 42010 Mancasale, Reggio Emilia, Italy.

B. Model number: ART 312A

2.02 Design

Configuration	Compact 2 way speaker
LF Sub-section	12" woofer, 2.5" voice coil
HF Sub-section	1"

2.03 Acoustical Proprieties

Nominal dispersion angle:	Horizontal: 90° - Vertical: 60°
Axial frequency range:	45Hz-20kHz

2.04 Physical Properties

Cabinet:	Composite PP
Rigging inserts:	4 M10 fly points and built in pole mount adaptor
Color:	Black
Grille:	Custom perforated steel grille with open-cell poly fiber backing
Input Connectors:	jack/xlr
Dimensions (H x W x D):	26.77" x 15.94" x 13.58" (680x405x345 mm)
Weight:	38.28 lbs. (17.4 kg)

2.05 Accessories

AC S260	Steel speaker floor stand with folding base end telescopic rod, tube Ø 35 mm
AC S140	Alluminium speaker floor stand with folding base end telescopic rod, tube Ø 35 mm
ART V-BR	Bracket for mounting one ART speaker on the wall - vertical. Adjustable inclination. Colour black.
ART H-BR	Bracket for mounting one ART speaker on the wall - horizontal. Adjustable inclination. Colour black.

