

ARTSERIES 

PASSIVE SPEAKER

ART 312 MKIII



The ART 312 is a two-way passive sound reinforcement speaker with careful acoustic design and innovative transducers technology.

The high frequencies are extremely accurate thanks to the 1" compression driver while a powerful mid-bass is guaranteed by a 12" high power woofer.

Installation is easy thanks to the four M10 flying points of the cabinet.

Applications

- Live Music
- Clubs
- Fixed Installations
- Stage monitoring

Features

300 Watt power handling

127 dB max spl

90 x 60, Wide dispersion constant directivity horn

12" woofer, high power 2.5" voice coil

1" HF driver, titanium dome, 1.5" v.c.

ACOUSTICAL SPECIFICATIONS

Frequency response:	50 - 20 KHz
Max SPL:	127 dB
Sensitivity 1W/1m:	99
Coverage angle:	90° x 60°
Compression driver:	1"
Woofer:	12"
Power handling:	300 w

INPUT SECTION

Input signal (Impedance):	8 ohm
Input connector:	speakon
Output signal connector:	speakon

PROCESSOR SECTION

Crossover frequencies:	1800 Hz
Protections:	electronic

PHYSICAL

Cabinet:	Composite PP
Dimensions (HxWxD):	26.77" x 15.94" x 13.58" (680x405x345 mm)
Weight:	35.27 lbs. (16 kg)
Hardware:	4 M10 flying points
Handles:	2 side, 1 top
Pole Mount / Cap:	yes
Colour:	Anthracyte gray

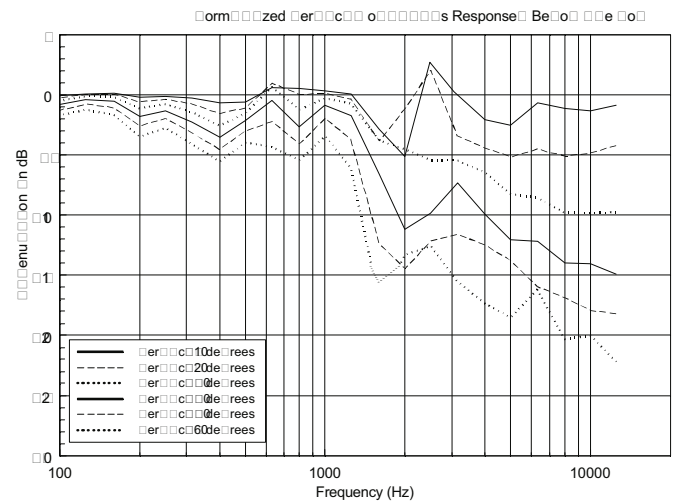
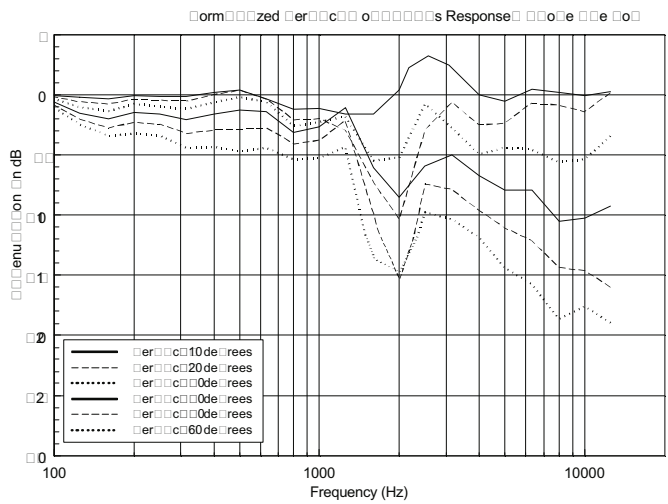
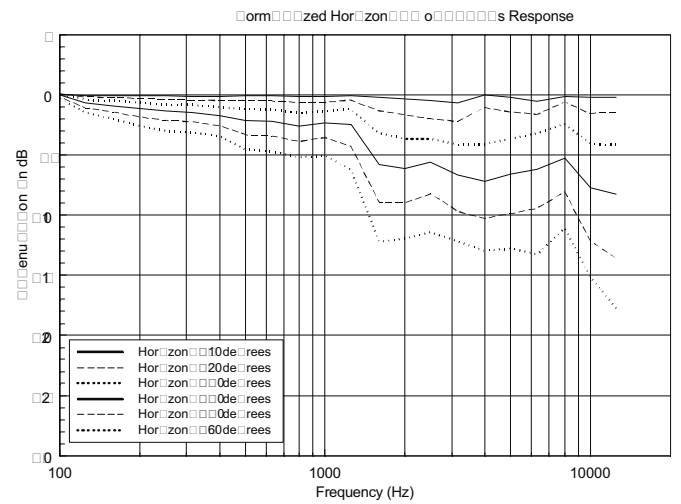
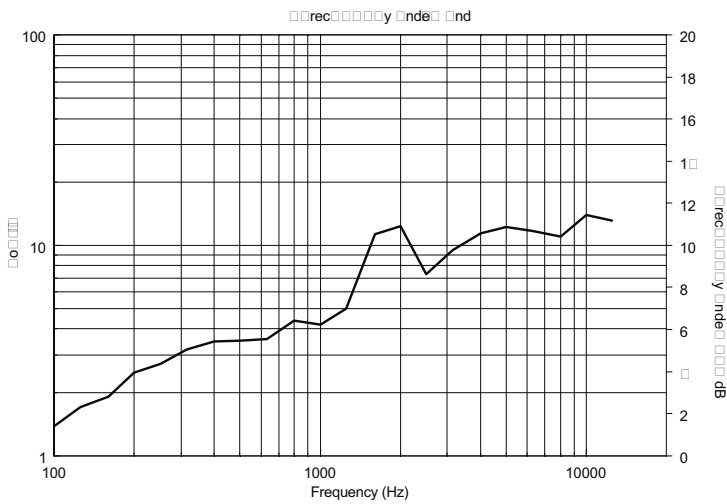
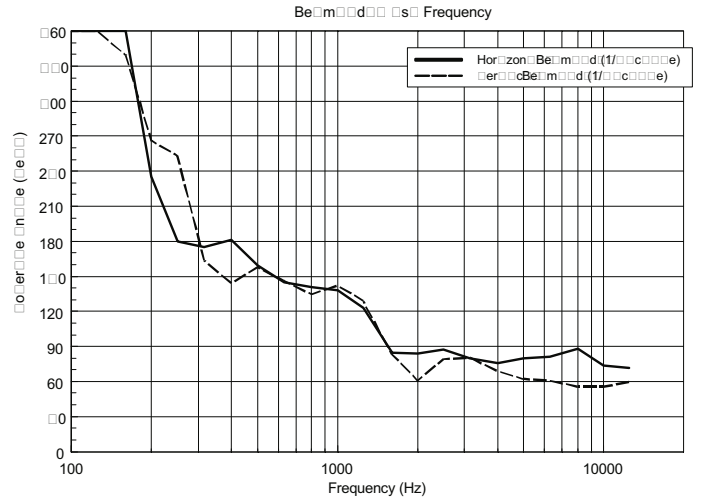
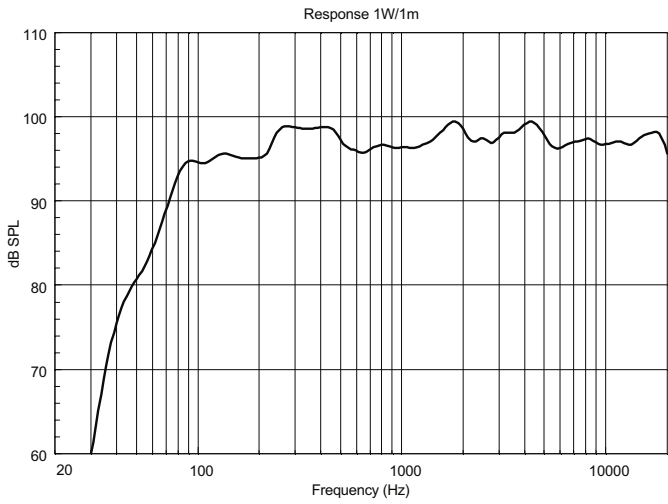

Horizontal 1/3 Polar Plot

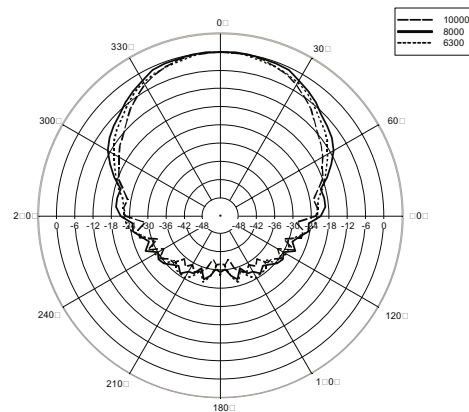
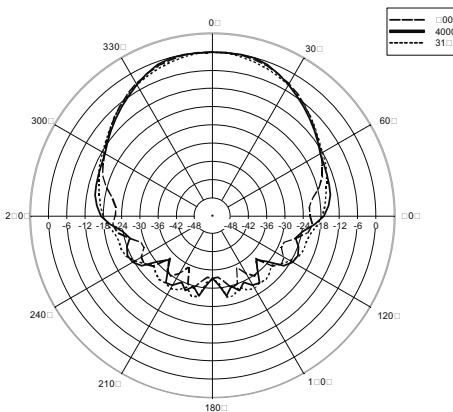
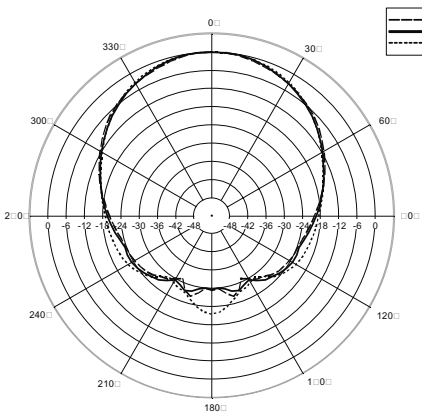
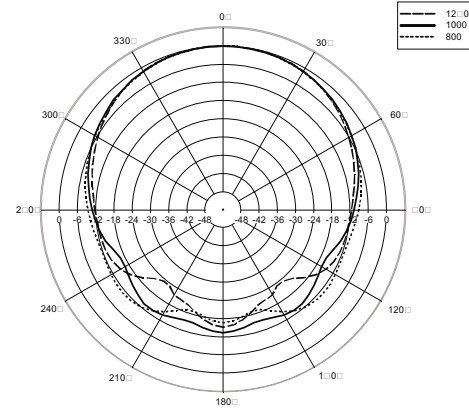
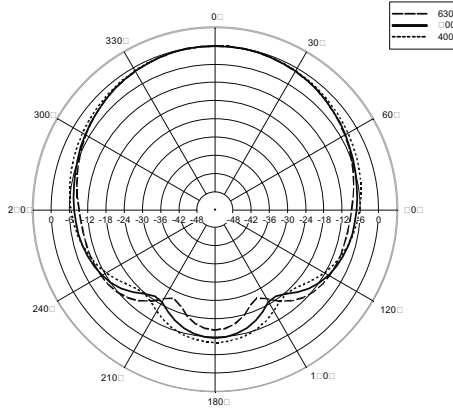
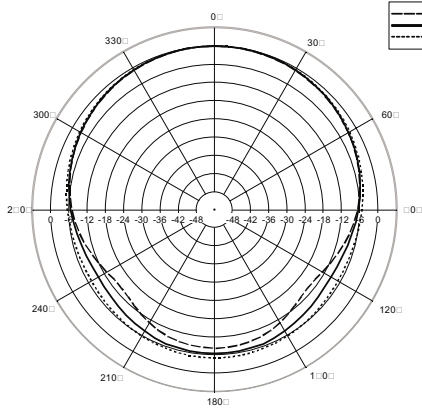

Vertical 1/3 Polar Plot

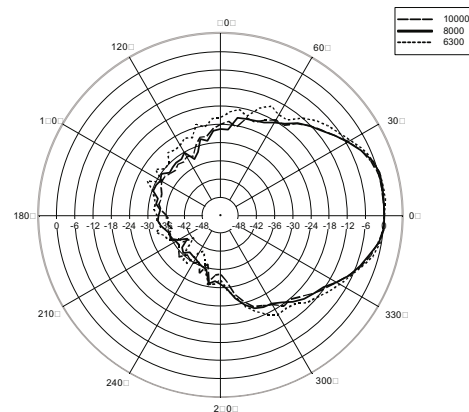
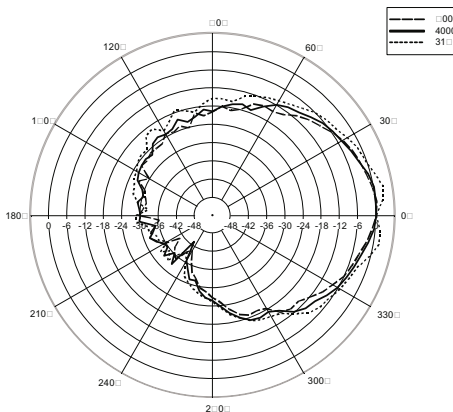
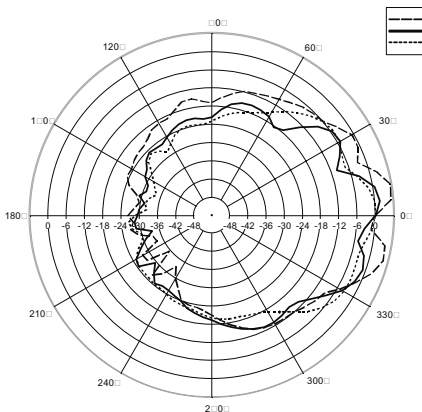
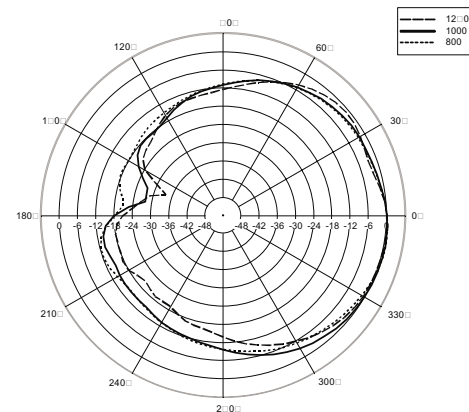
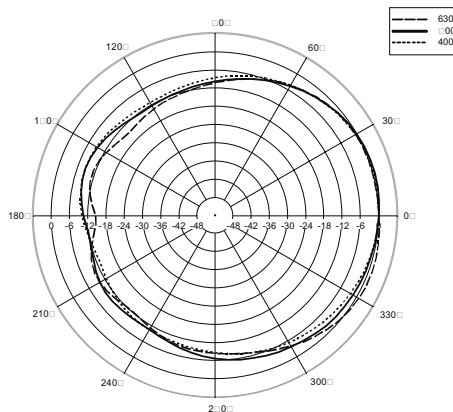
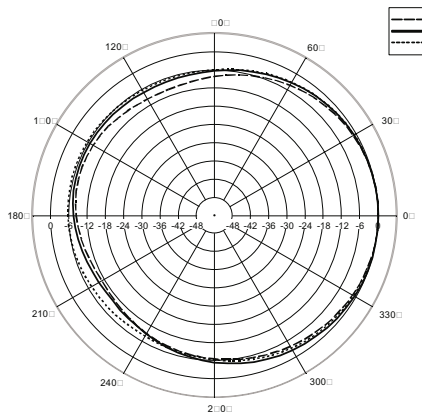

CSI PRODUCT SPECIFICATIONS FOR DESIGNERS, SPECIFIERS, AND CONSULTANTS (ALSO KNOWN AS “A&E SPECIFICATIONS”) The following are “Part 2 Products” CSI-type specifications. It is assumed that “Part 1 General – Administrative and Procedures” and “Part 3 Execution – Installation and Maintenance” are part of an overall audio system or project specification.
PART 2 PRODUCTS

2.01 Approved Manufacturer/Product

- A. RCF, Via Raffaello 13, 42010 Mancasale, Reggio Emilia, Italy.
- B. Model number: ART 312

2.02 Design

Configuration	Compact 2 way speaker
LF Sub-section	15" high power woofer, 64mm edge wound aluminium coil
HF Sub-section	1"

2.03 Acoustical Proprieties

Nominal dispersion angle:	Horizontal: 90° - Vertical: 60°
Axial frequency range:	50Hz-20kHz

2.04 Physical Properties

Cabinet:	Composite PP
Rigging inserts:	4 M10 fly points and built in pole mount adaptor
Color:	Anthracyte gray
Grille:	Custom perforated steel grille with open-cell poly fiber backing
Input Connectors:	Speakon
Dimensions (H x W x D):	26.77" x 15.94" x 13.58" (680x405x345 mm)
Weight:	35.27 lbs. (16 kg)

2.05 Accessories

AC S260	Steel speaker floor stand with folding base end telescopic rod, tube Ø 35 mm
AC S140	Alluminium speaker floor stand with folding base end telescopic rod, tube Ø 35 mm
ART V-BR	Bracket for mounting one ART speaker on the wall - vertical. Adjustable inclination. Colour black.
ART H-BR	Bracket for mounting one ART speaker on the wall - horizontal. Adjustable inclination. Colour black.

