

CS 6940EN

TWO-WAY COLUMN SPEAKER

DESCRIPTION

CS 6940EN is a compact and elegant two-way column speaker providing highly intelligible voice reproduction, and suitable for installation into places of worship, stations, subways and many other environments. The terminal connection blocks, for input and output flameproof cables, are made of ceramic material. A thermal fuse protects the integrity of the line in case of heat affecting the speaker. Ground screw available (if needed). Thanks to its IP66 protection grade, it can be installed both indoor and outdoor.

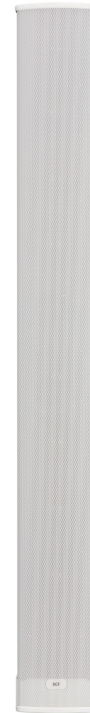

FEATURES

- 8 x 3" fullrange transducers with 0.75" dome tweeter.
- Power selectable (100 V): 40 W – 20 W – 10 W – 5 W – 2.5 W.
- 95 dB sensitivity.
- Colour white RAL 9003.
- Aluminium body, grille and bracket.
- In/out ceramic terminal block.
- Thermal fuse protection.
- Protection grade IP66.

TECHNICAL SPECIFICATIONS

Acoustical specifications	Frequency Response (-10dB):	140 Hz ÷ 20000 Hz
	Max SPL @ 1m:	109 dB
	Max SPL @ 4m:	97 dB
	Horizontal coverage angle:	194°
	Vertical coverage angle:	30°
	System Sensitivity:	95 dB
	System Sensitivity 1W @ 4m:	83 dB
Power section	Power Handling:	40 W RMS
	Peak Power Handling:	160 W PEAK
	Recommended Amplifier:	80 W
	Protections:	Thermal fuse
Transducers	Dome Tweeter:	0.75"
	Fullrange:	8 x 3.0"
Input/Output section	Input connectors:	Ceramic screw terminals
	Output connectors:	Ceramic screw terminals
	Constant Voltage Transformer:	70/100 V
	Power selection 1:	40 W - 250 ohm
	Power selection 2:	20 W - 500 ohm
	Power selection 3:	10 W - 1000 ohm
	Power selection 4:	5 W - 2000 ohm
Power selection 5:	2.5 W - 4000 ohm	
Standard compliance	IP protection grade:	IP 66
	EN54-24 certified:	Yes
	CE marking:	Yes
	CPR number:	1488-CPR-0490/W
Physical specifications	Cabinet/Case Material:	Aluminium
	Grille:	Aluminium
	Color:	White - RAL 9003
Size	Height:	995 mm / 39.17 inches
	Width:	114 mm / 4.49 inches
	Depth:	96 mm / 3.78 inches
	Weight:	7 kg / 15.43 lbs
Shipping informations	Package Height:	2000 mm / 78.74 inches
	Package Width:	1090 mm / 42.91 inches
	Package Depth:	1700 mm / 66.93 inches
	Package Weight:	8.4 kg / 18.52 lbs



PART NUMBER

- **13100005**

CS 6940EN

EAN 8024530013684

DRAWINGS

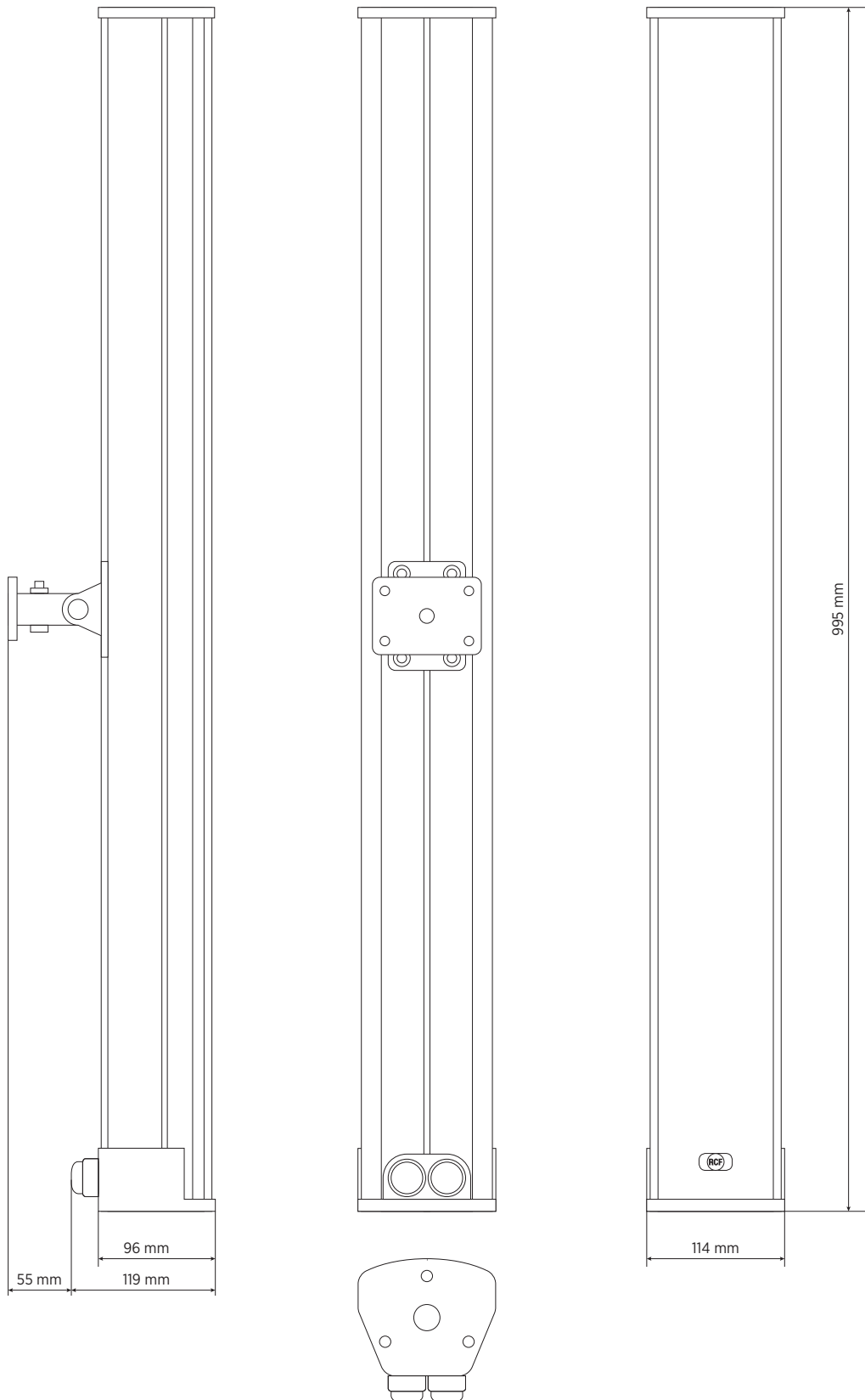

SCHEMATICS

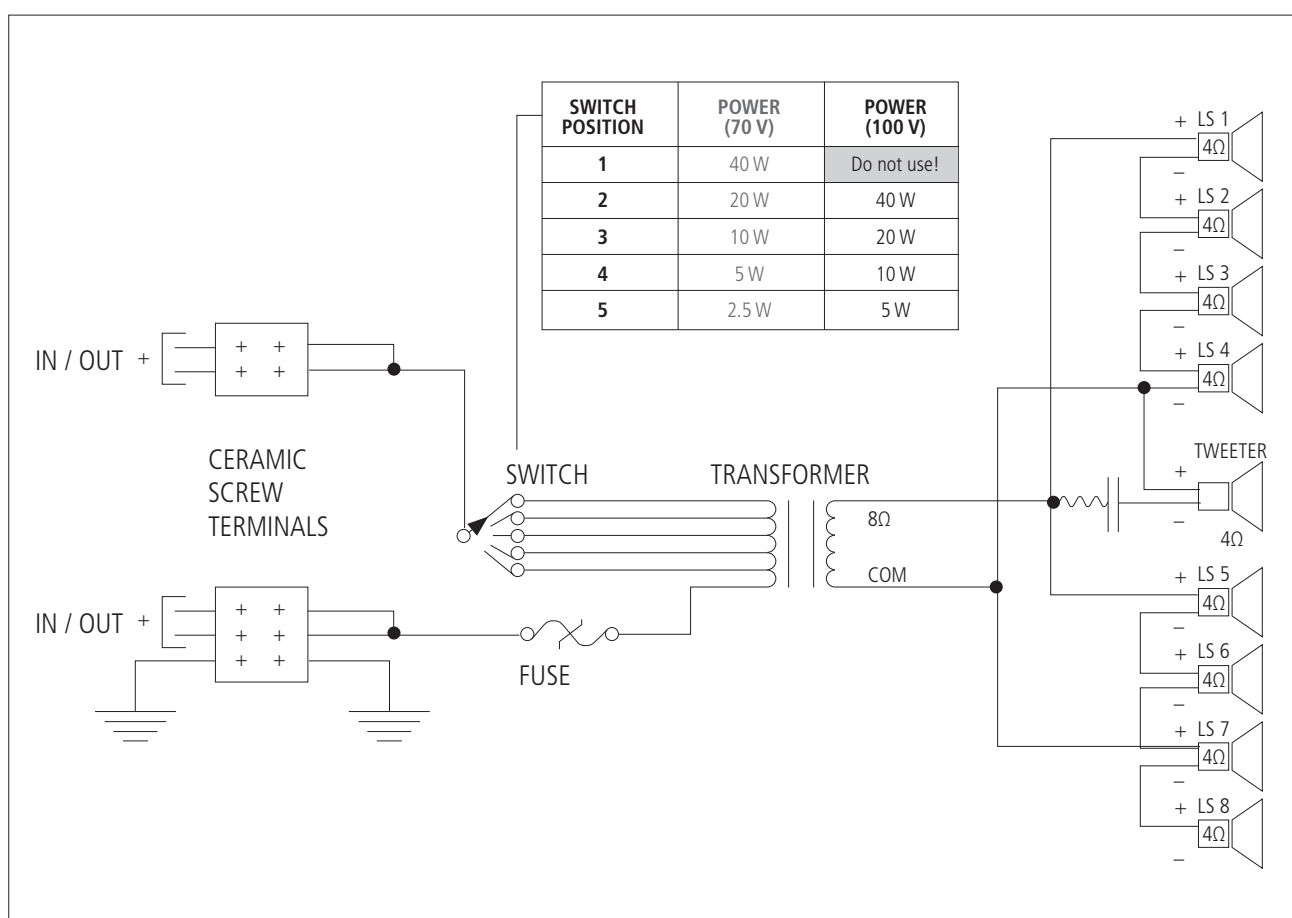

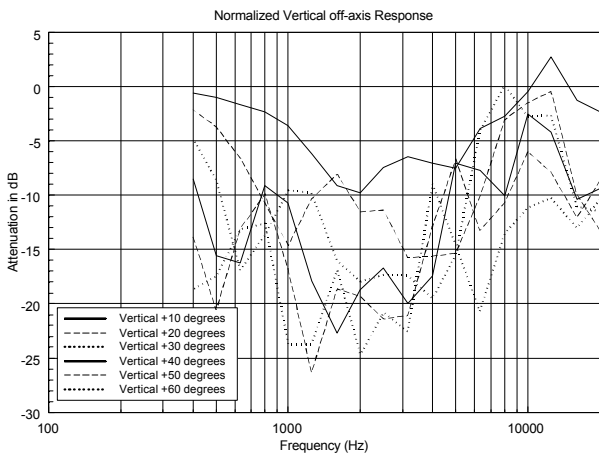
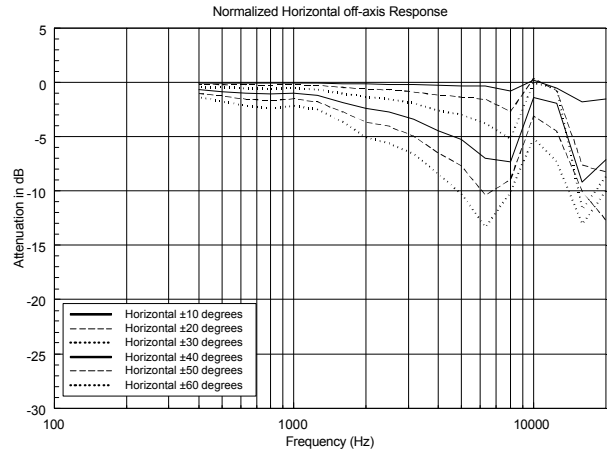
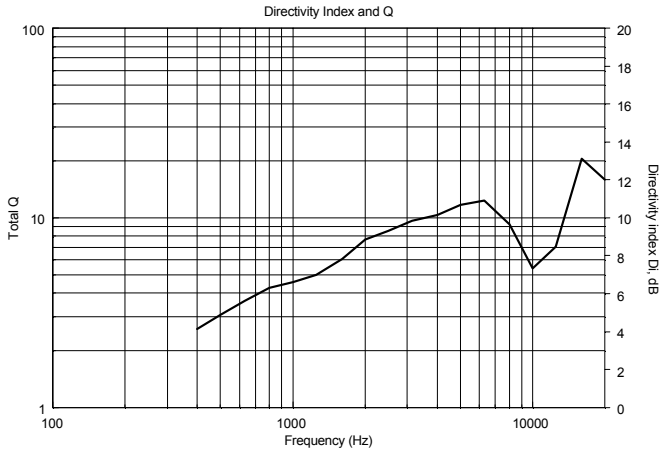
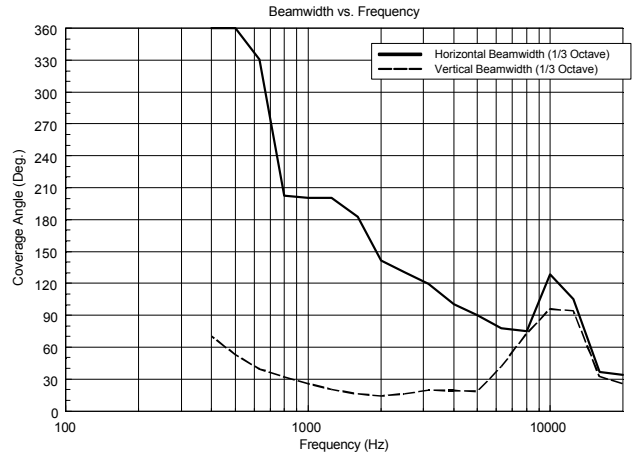

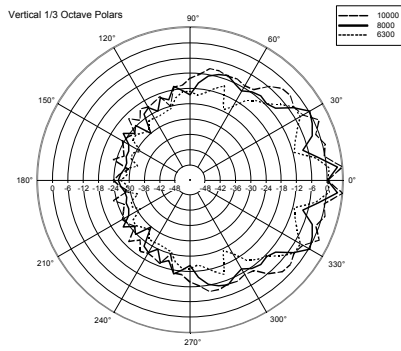
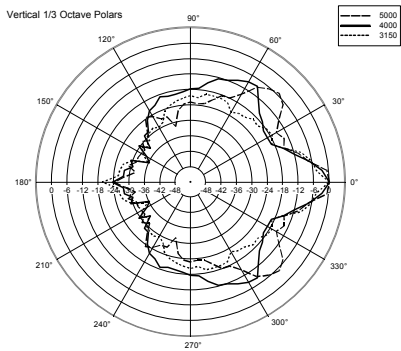
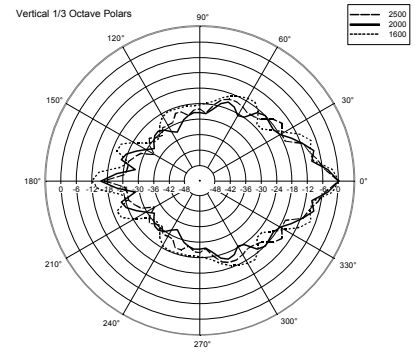
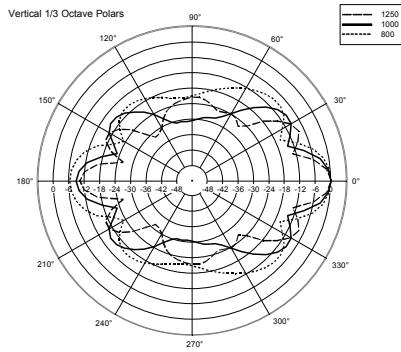
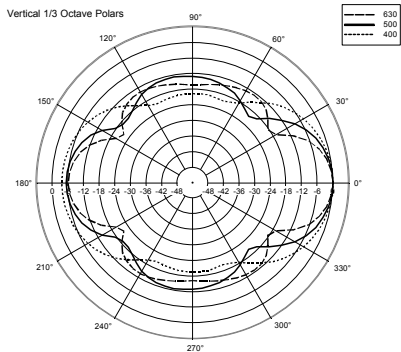
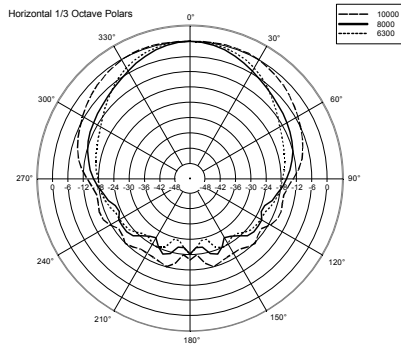
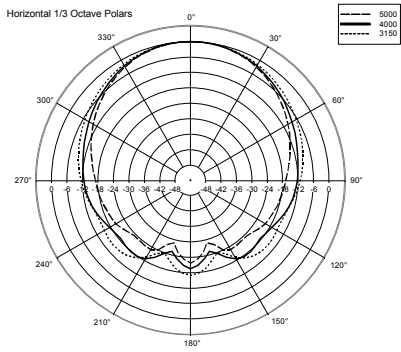
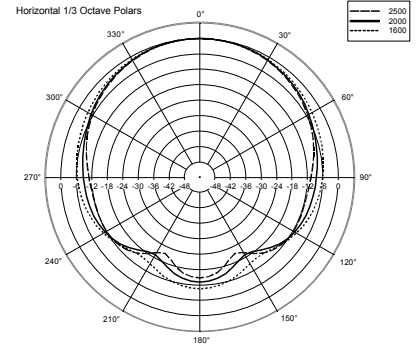
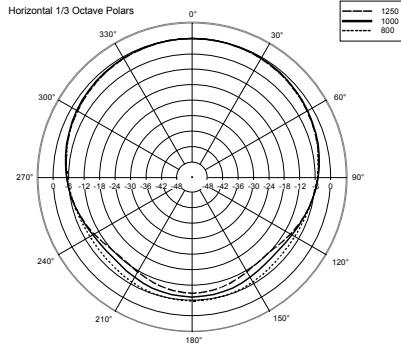
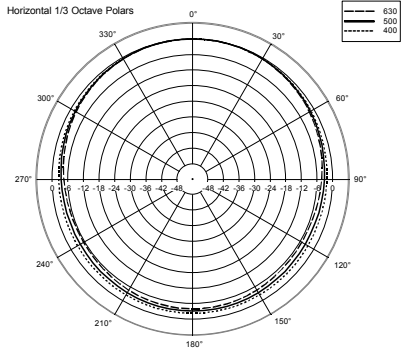



ACCESSORIES

A&E SPECIFICATIONS

The product shall be a compact and elegant two-way column speaker for broadcasting background music into commercial spaces, but also alarm messages, thanks to the highly intelligible voice reproduction and the EN 54-24 certification.

It shall be suitable for places of worship, stations, subways or any other environment.

It shall have IP66 protection grade for both indoor and outdoor installations.

It shall feature an aluminium body and front grille.

The terminal connection blocks, for input and output flameproof cables, shall be made of ceramic material. A thermal fuse shall protect the line integrity in case of heat affecting the speaker.

NOTES

NO CAUTION is NECESSARY in case of ALERTED PERSON for AUDIO voltages up to 120V, when warning symbols are present near the connection terminals. In the case of AUDIO voltages up to 71V, it is not even necessary to put warning symbols.

No need of linking to earth metal parts of speakers equipped with transformers and connected to 70.7 V / 100 V outputs of power amplifiers that do not have any reference to earth (ref. EN 62368-1 item 4.3.2.2), unless specific local requirements.
