

BS 8

DIFFUSORE A SFERA PER INSTALLAZIONE SOSPESA

DESCRIZIONE

BS8 è un diffusore di forma sferica studiato per un'installazione sospesa ed indicato per la sonorizzazione di grandi superfici. Incorpora un altoparlante da 200 mm (8") che consente una riproduzione sonora di qualità, con un'ottima intelligibilità della parola.



CARATTERISTICHE

- Installazione a sospensione in ambienti con soffitti alti
- Cavo di collegamento in sospensione lungo 5 m
- Altoparlante a gamma estesa diametro 200 mm (8")
- Corpo in materiale plastico
- Colore bianco RAL 9010
- Trasformatore per il collegamento con linee a tensione costante di 100 V

SPECIFICHE TECNICHE

Specifiche acustiche	Risposta in Frequenza (-10dB):	160 Hz ÷ 12500 Hz
	Max SPL @ 1m (dB):	106 dB
	Angolo di copertura orizzontale (*):	360°
	Sensibilità del sistema (dB)	93 dB
Sezione di potenza	Potenza:	20 W RMS
	Potenza di Picco:	80 W PEAK
	Amplificatore Raccomandato	40 W
Trasduttori	Woofers:	8"
Sezione Input/Output	Connettori in ingresso:	Cable
	Conessioni di uscita:	Cable
	Trasformatore a Tensione Costante	100 V
	Selettore di potenza 1 (100V):	20 W - 500 ohm
	Selettore di potenza 1 (100V):	10 W - 1000 ohm
	Selettore di potenza 1 (100V):	5 W - 2000 ohm
Conformità agli standard	Marchio CE:	Yes
Specifiche fisiche	Materiale Cabinet/Case:	Plastic
	Hardware:	Carabiner and safety steel wire
	Griglia:	Plastic
	Colore:	White - RAL 9010
Dimensioni	Altezza:	240 mm / 9.45 inches
	Diametro:	250 mm / 9.84 inches
	Peso:	2.3 kg / 5.07 lbs
Informazioni di spedizione	Altezza imballaggio:	300 mm / 11.81 inches
	Larghezza imballaggio:	315 mm / 12.4 inches
	Profondità imballaggio:	315 mm / 12.4 inches
	Peso imballaggio:	3.55 kg / 7.83 lbs

CODICE

- **13133054**

BS 8

EAN 8024530005733

DRAWINGS

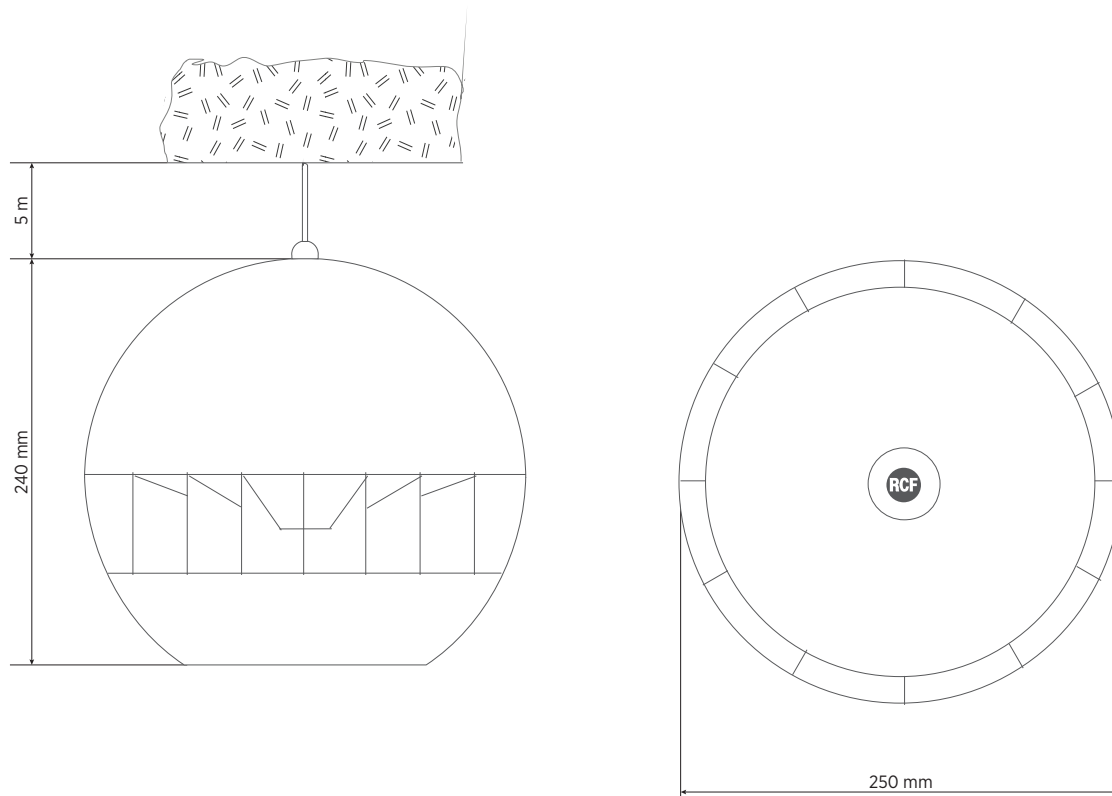

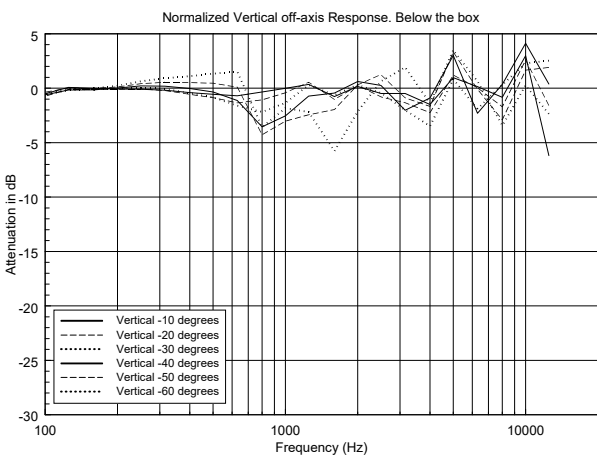
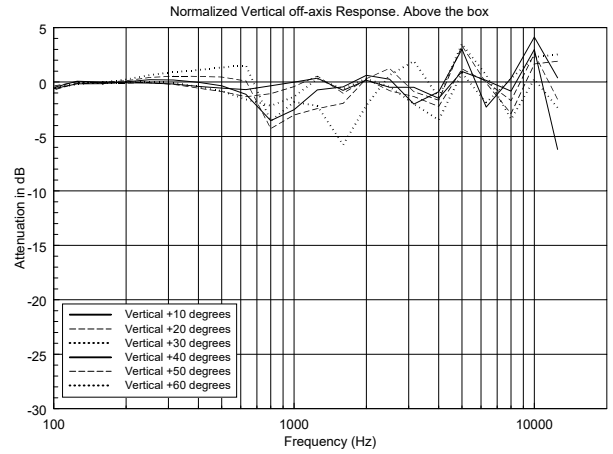
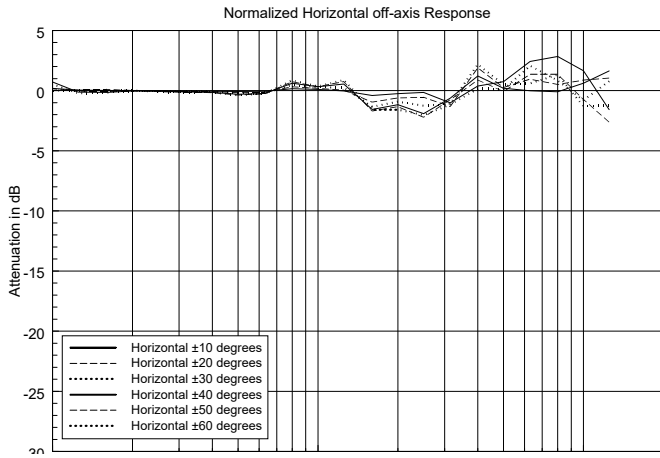
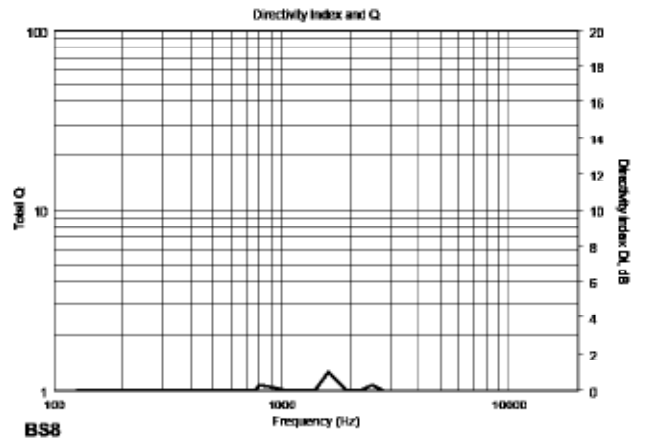
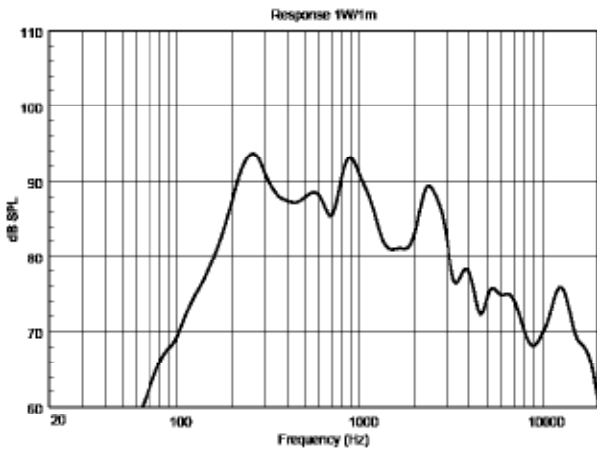

HORIZONTAL 1/3 POLAR PLOT

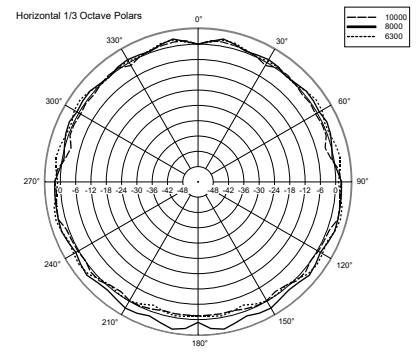
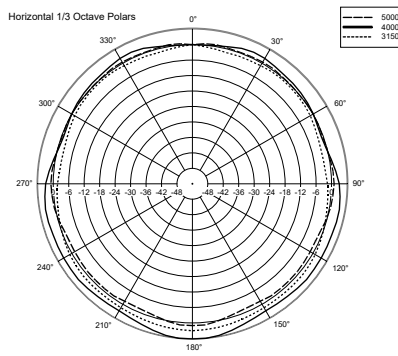
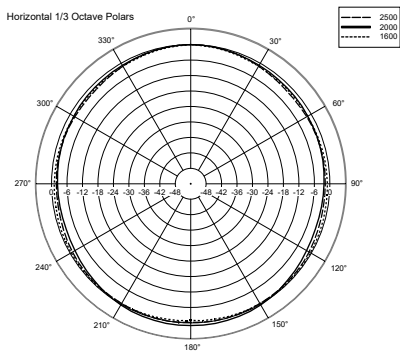
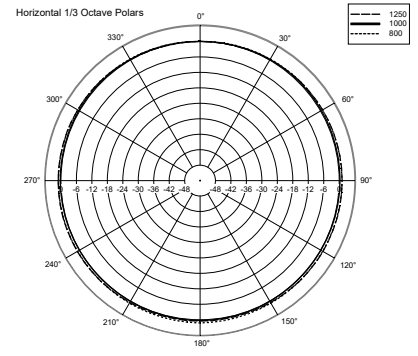
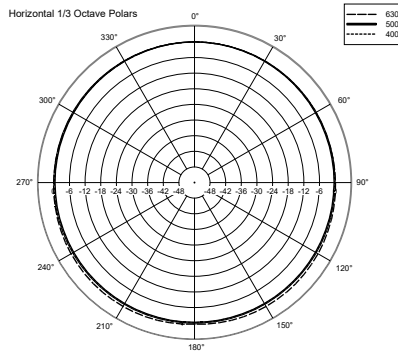
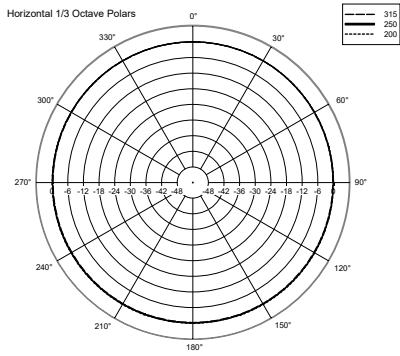

VERTICAL 1/3 POLAR PLOT

