

NXL 24-A

ACTIVE TWO-WAY ARRAY

DESCRIPTION

The NXL 24-A is an active column speaker array system composed by 4 x 6" high power woofers and a 2.5" voice coil compression driver loaded from a waveguide on a 100° x 30° constant directivity horn. The amplifier delivers 1400 Watt and is controlled by a DSP that takes care of crossover, equalisation, phase alignment, soft limiting and speaker protections. Equalisations are available to operate with a single column or in pairs



FEATURES

- 1400 Watt
- 131 dB max SPL
- 65 Hz 20 kHz frequency response
- 4 x 6" Woofers
- 2.5" voice coil RCF Precision C. Driver on waveguide
- 100° x 30° slightly tilted pattern control
- DSP controlled Input section with single or dual eq. preset
- Pole mountable, Stackable, Flyable
- Baltic Birch Plywood enclosure with internal structural metal bracings

TECHNICAL SPECIFICATIONS

Acoustical specifications	Frequency Response:	65 Hz ÷ 20000 Hz
	Max SPL @ 1m:	131 dB
	Horizontal coverage angle:	100°
	Vertical coverage angle:	30°
Transducers	Compression Driver:	1.4", 2.5" v.c
	Woofer:	4 x 6.0", 1.5" v.c
Input/Output section	Input signal:	bal/unbal
	Input connectors:	XRL, Jack
	Output connectors:	XLR
	Input sensitivity:	-2 dBu/+4 dBu
Processor section	Crossover Frequencies:	800 Hz
	Protections:	Thermal, RMS
	Limiter:	Soft Limiter
	Controls:	Volume, EQ Shape, Mlc/Line
Power section	Total Power:	1400 W Peak, 700 W RMS
	Low frequencies:	1000 W Peak, 500 W RMS
	Cooling:	Convection
	Connections:	Powercon IN/OUT
Standard compliance	CE marking:	Yes
Physical specifications	Cabinet/Case Material:	Baltic birch plywood
	Hardware:	4 x MB, 4 x quick lock
	Handles:	2 side
	Pole mount/Cap:	Yes
	Grille:	Steel
	Color:	Black
Size	Height:	1056 mm / 41.57 inches
	Width:	201 mm / 7.91 inches
	Depth:	274 mm / 10.79 inches
	Weight:	26.4 kg / 58.2 lbs
Shipping informations	Package Height:	316 mm / 12.44 inches
	Package Width:	1155 mm / 45.47 inches
	Package Depth:	222 mm / 8.74 inches
	Package Weight:	29 kg / 63.93 lbs



PART NUMBER

• **13000400**

NXL 24-A

115V

EAN 8024530010812

• **13000399**

NXL 24-A

220-240V

EAN 8024530010805

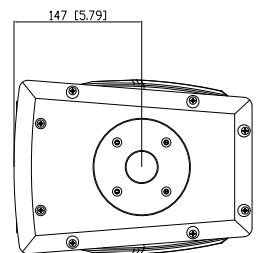
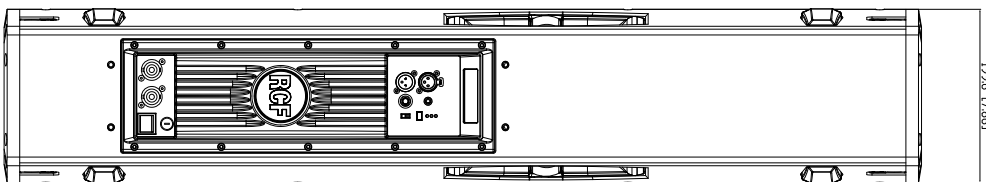
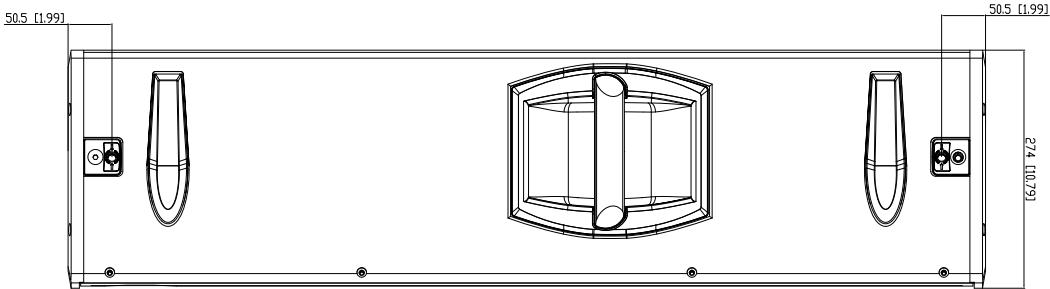
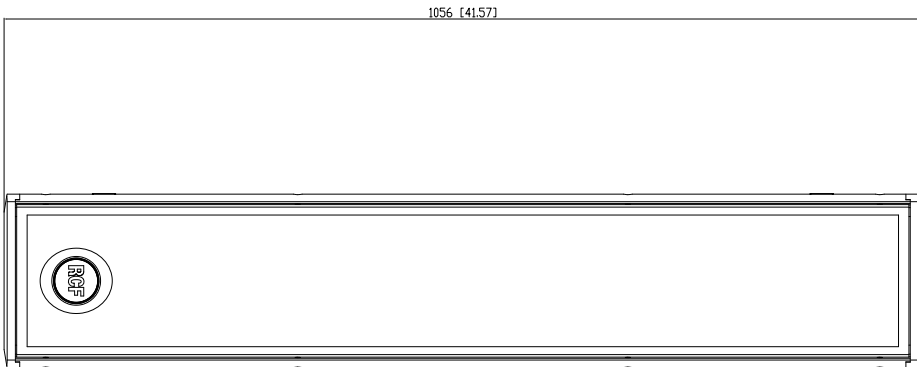
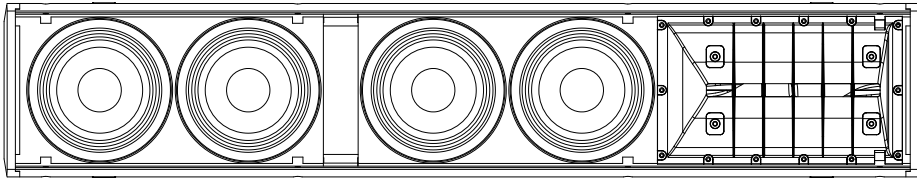

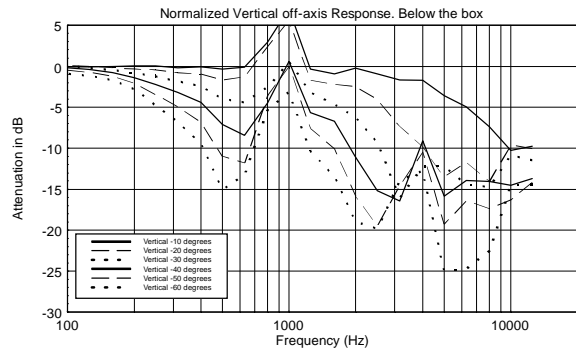
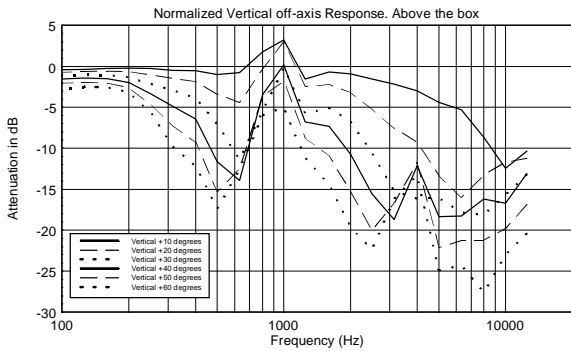
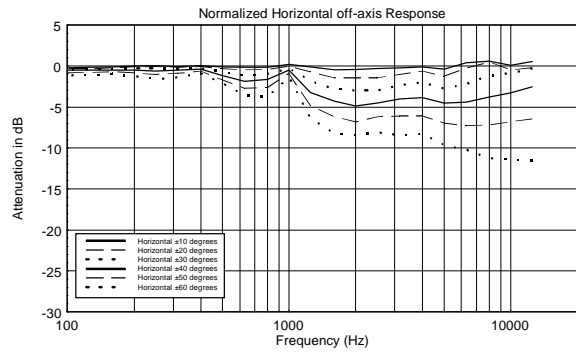
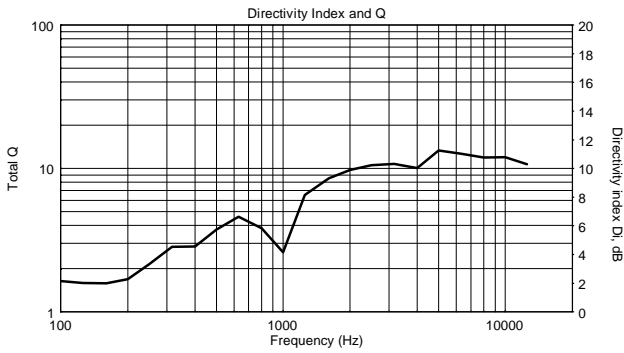
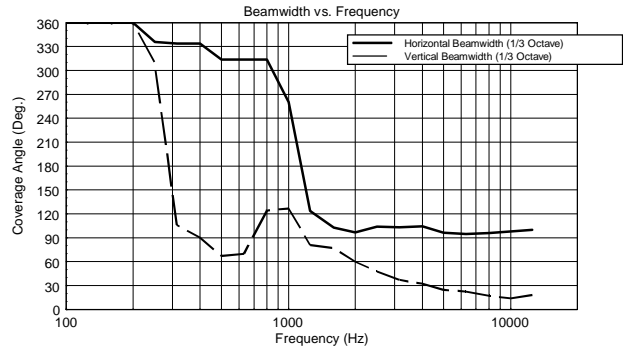
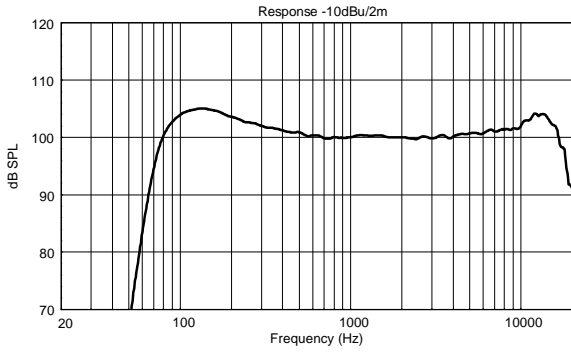

Horizontal 1/3 Octave Polars

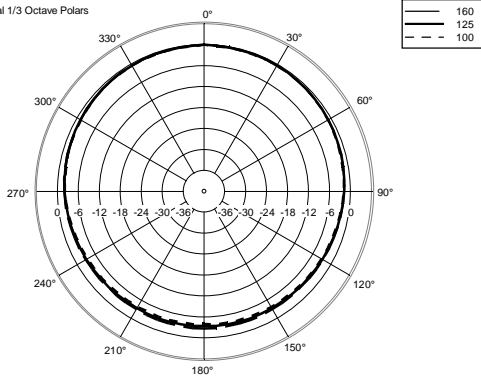

Horizontal 1/3 Octave Polars

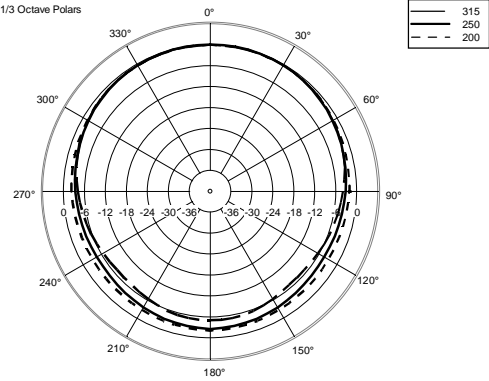

Horizontal 1/3 Octave Polars

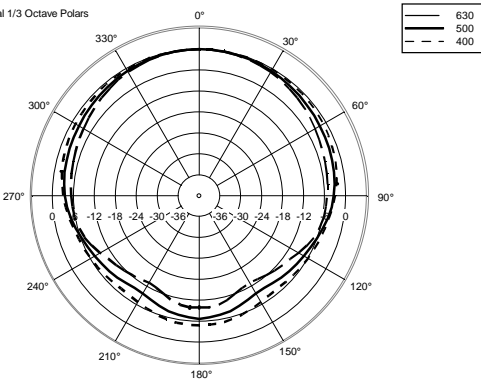

Horizontal 1/3 Octave Polars

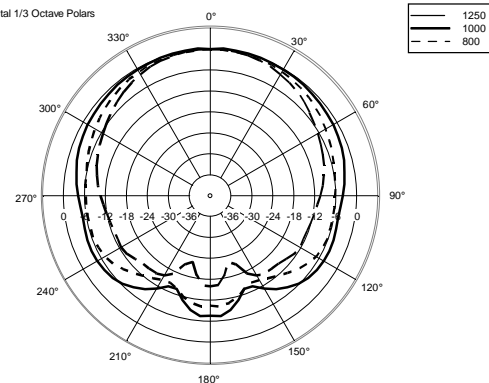

Horizontal 1/3 Octave Polars

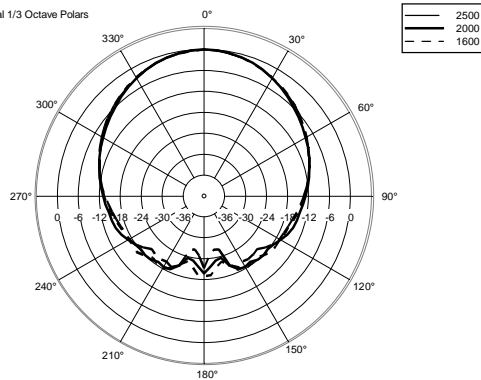

Horizontal 1/3 Octave Polars

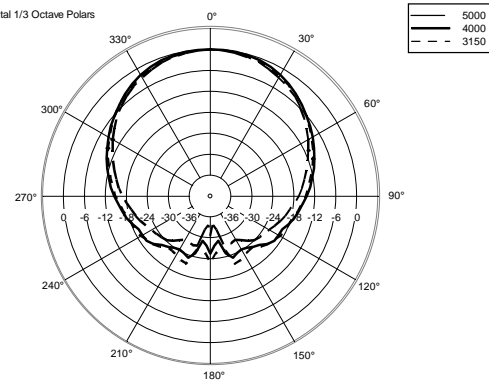

Horizontal 1/3 Octave Polars

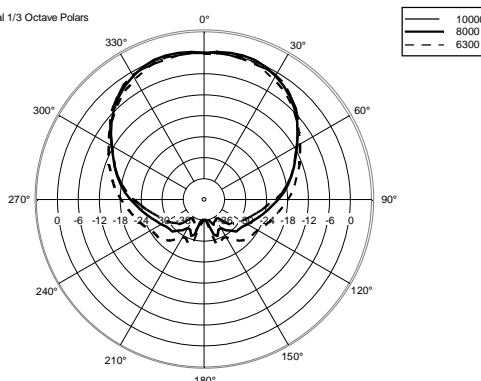

Horizontal One Octave Polars

