

NXL 24-A

ARRAY ATTIVO A DUE VIE

DESCRIZIONE

L'NXL 24-A è un sistema attivo Line Array a colonna composto da 4 woofer da 6" ad alta potenza e un driver a compressione dotato di bobina da 2,5" con guida d'onda, caricato da una tromba a direttività costante 100° x 30°. L'amplificatore da 1400 Watt è controllato da un DSP che gestisce crossover, equalizzazione, allineamento di fase, soft limiting e dispositivi di protezione dei diffusori. L'equalizzazione può essere applicata secondo l'impiego dei diffusori, come singole unità o in coppie.



CARATTERISTICHE

- 1400 Watt
- 131 dB max SPL
- Risposta in frequenza 65 Hz - 20 kHz
- 4 x 6" Woofers
- Driver con bobina da 2,5" RCF Precision C con guida d'onda
- Pattern di emissione 100° x 30° con leggera inclinazione
- Sezione Input controllata da DSP con preset di equalizzazione singoli o di coppia
- Montaggio su palo, in stacking o in sospensione
- Cabinet in multistrato di Betulla del baltico con rinforzi strutturali interni in metallo

SPECIFICHE TECNICHE

Specifiche acustiche	Risposta in Frequenza:	65 Hz ÷ 20000 Hz
	Max SPL @ 1m (dB):	131 dB
	Angolo di copertura orizzontale (*):	100°
	Angolo di copertura verticale (*):	30°
Trasduttori	Driver a Compressione:	1.4", 2.5" v.c
	Woofer:	4 x 6.0", 1.5" v.c
Sezione Input/Output	Segnale di Ingresso:	bal/unbal
	Connettori in ingresso:	XRL, Jack
	Connessioni di uscita:	XLR
	Sensibilità di ingresso:	-2 dBu/+4 dBu
Sezione del processore	Frequenze Crossover:	800 Hz
	Protezioni:	Thermal, RMS
	Limiter:	Soft Limiter
	Controlli:	Volume, EQ Shape, Mlc/Line
Sezione di potenza	Potenza Totale:	1400 W Peak, 700 W RMS
	Basse frequenze:	1000 W Peak, 500 W RMS
	Raffreddamento:	Convection
	Connessioni:	Powercon IN/OUT
Conformità agli standard	Marchio CE:	Yes
Specifiche fisiche	Materiale Cabinet/Case:	Baltic birch plywood
	Hardware:	4 x MB, 4 x quick lock
	Maniglie:	2 side
	Pole mount/Cap:	Yes
	Griglia:	Steel
	Colore:	Black
Dimensioni	Altezza:	1056 mm / 41.57 inches
	Larghezza:	201 mm / 7.91 inches
	Profondità:	274 mm / 10.79 inches
	Peso:	26.4 kg / 58.2 lbs
Informazioni di spedizione	Altezza imballaggio:	316 mm / 12.44 inches
	Larghezza imballaggio:	1155 mm / 45.47 inches
	Profondità imballaggio:	222 mm / 8.74 inches
	Peso imballaggio:	29 kg / 63.93 lbs



CODICE

• **13000400**

NXL 24-A

115V

EAN 8024530010812

• **13000399**

NXL 24-A

220-240V

EAN 8024530010805

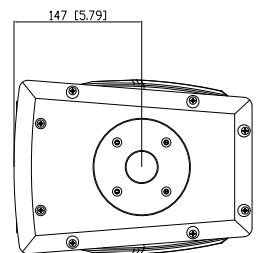
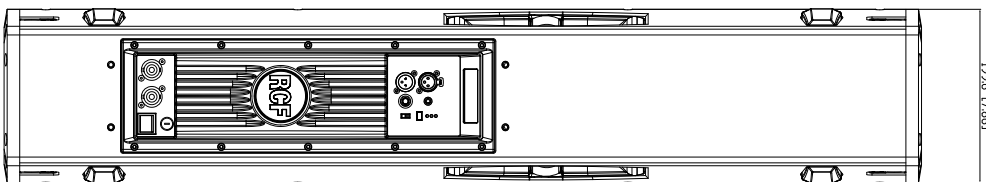
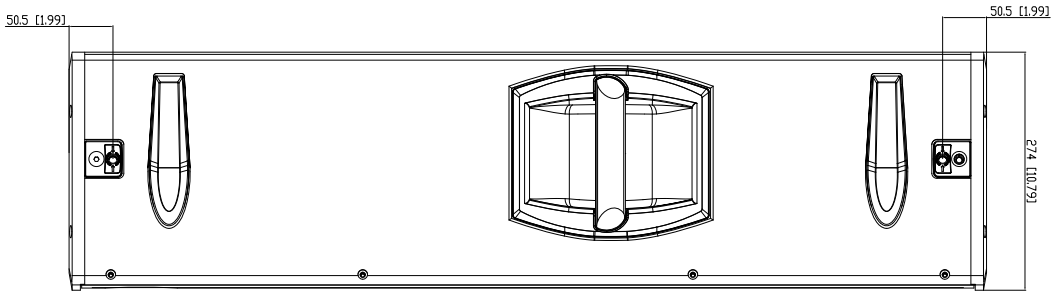
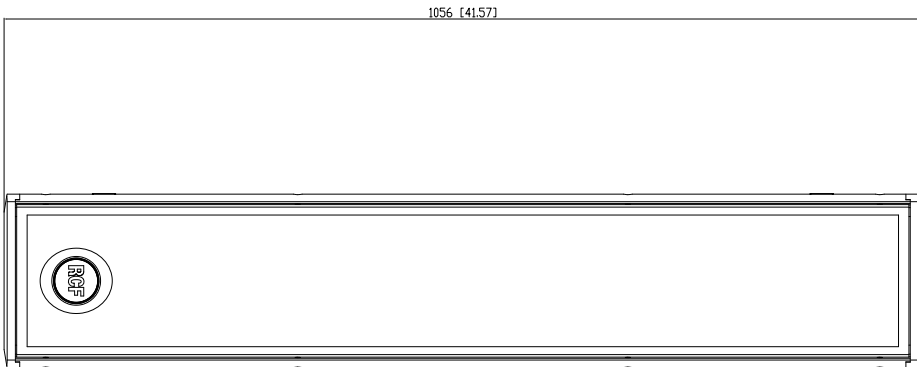
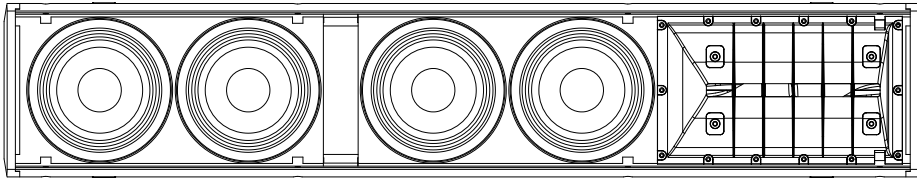

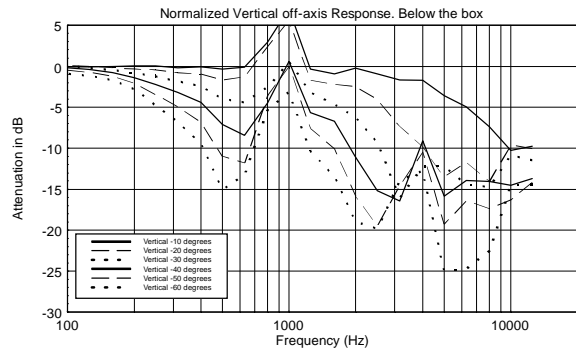
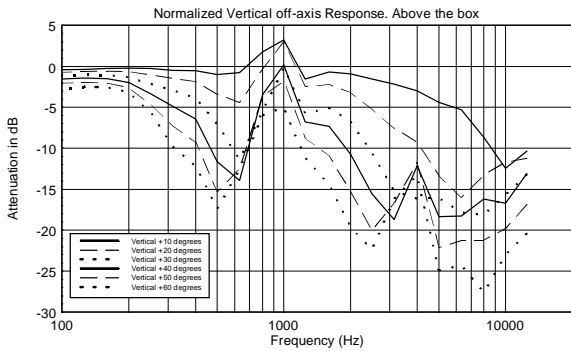
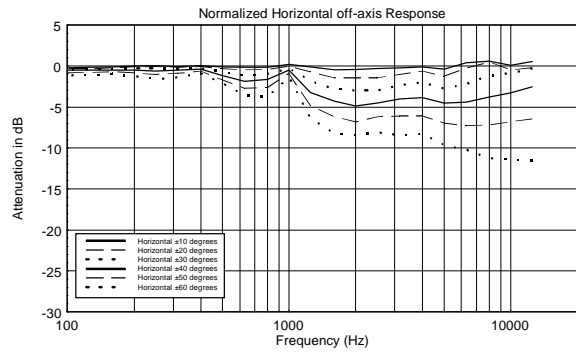
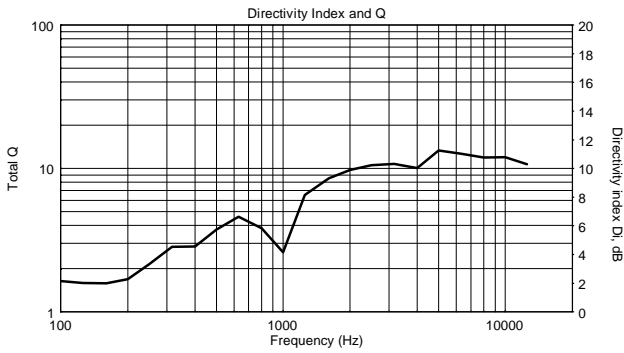
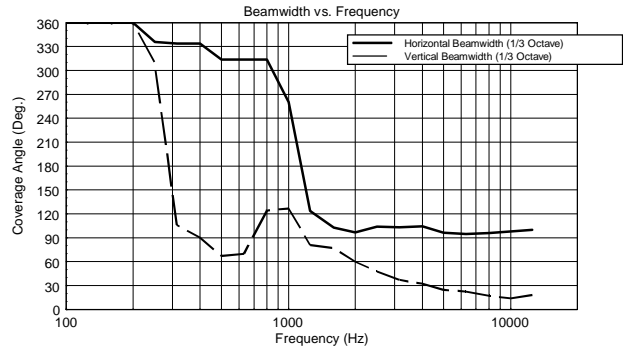
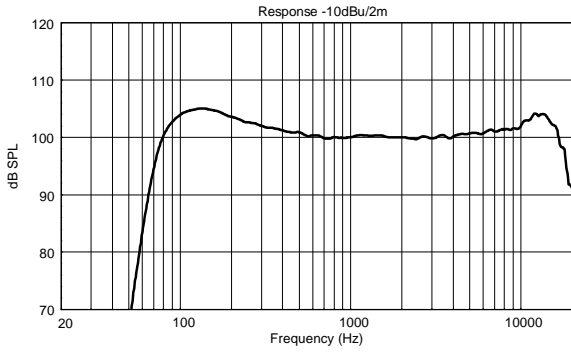

Horizontal 1/3 Octave Polars

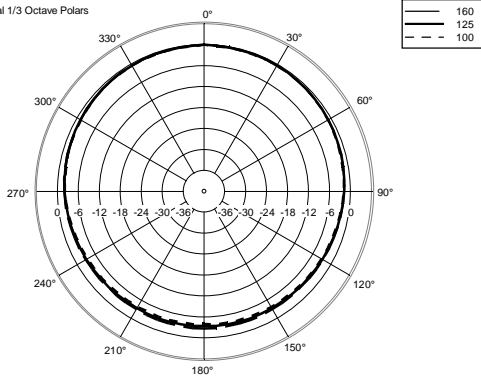

Horizontal 1/3 Octave Polars

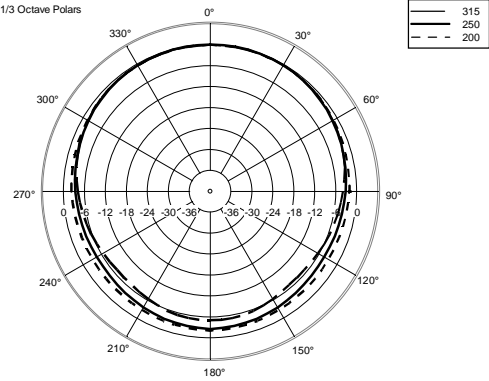

Horizontal 1/3 Octave Polars

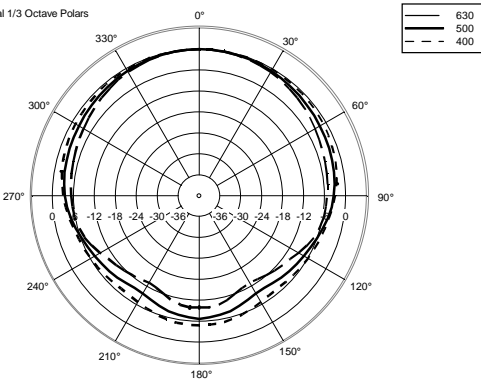

Horizontal 1/3 Octave Polars

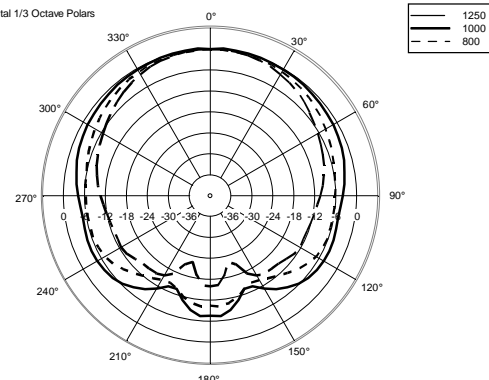

Horizontal 1/3 Octave Polars

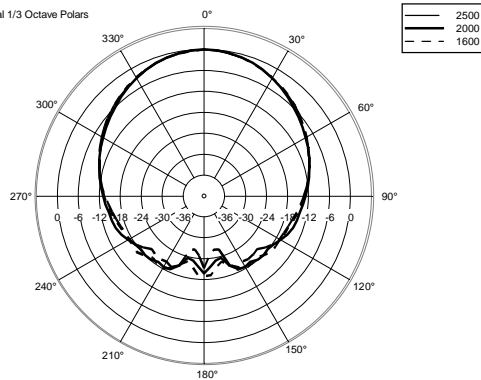

Horizontal 1/3 Octave Polars

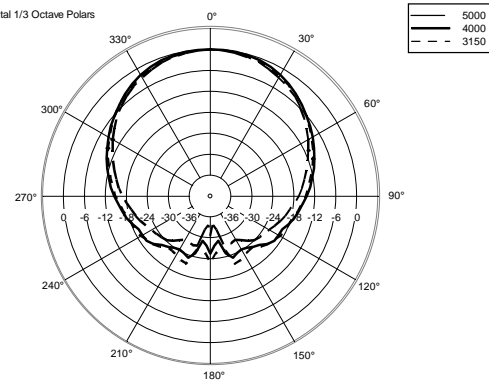

Horizontal 1/3 Octave Polars

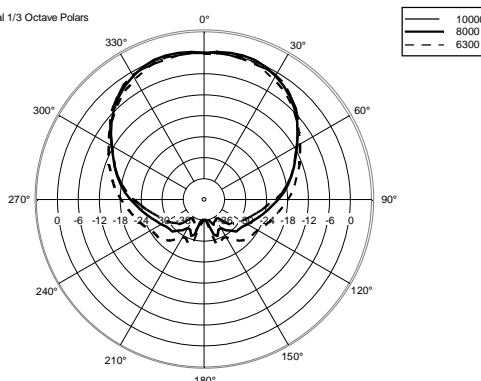

Horizontal One Octave Polars

