

# NXL 24-A

## AKTIVES 2-WEGE-SÄULENSYSTEM

### BESCHREIBUNG

Das NXL 24-A ist ein aktives Säulensystem, bestückt mit 4 x 6-Zoll-Hochleistungstieftönern sowie einem Kompressionstreiber mit 2,5-Zoll-Schwingspule und einer Kombination aus Constant-Directivity-Horn mit 100° x 30° Abstrahlung und Waveguide. Die 1400-Watt-Endstufe wird von einem digitalen Signalprozessor gesteuert, der Frequenzweiche, Klangregelung, Phasensteuerung, Soft Limiting und Lautsprecherschutz kontrolliert. Die Klangregelung ist für einen einzelnen oder zwei Säulenlautsprecher im Headstack angepasst.



### FUNKTIONEN

- 1400 WATT
- 131 dB maximaler Schalldruckpegel
- FREQUENZGANG 65 HZ - 20000 HZ
- 4 x 6-ZOLL-TIEFTÖNER
- HOCHPRÄZISER RCF KOMPRESSIONSTREIBER MIT 2,5-ZOLL-SCHWINGSPULE AUF WAVEGUIDE
- Leicht nach unten geneigter Abdeckungsbereich von 100° x 30°
- DSP-gesteuerte Eingangssektion mit individuellem oder paarweisem EQ-Preiset
- Hochständermontage, geflogene Anwendung, stapelbar
- Gehäuse aus Birken-Multiplex mit internen Verstrebungen aus Metall

## SPEZIFIKATIONEN

<b>Spezifikation</b>	Frequenzgang:	65 Hz ÷ 20000 Hz
	Max SPL @ 1m (dB):	131 dB
	Horizontaler Abstrahlwinkel (°):	100°
	Vertikaler Abstrahlwinkel (°):	30°
<b>Schallwandler</b>	Kompressionstreiber:	1.4", 2.5" v.c
	Woofer:	4 x 6.0", 1.5" v.c
<b>Input/Output Sektion</b>	Eingangssignal:	bal/unbal
	Eingangsbuchsen:	XRL, Jack
	Ausgangsanschlüsse:	XLR
	Eingangsempfindlichkeit:	-2 dBu/+4 dBu
<b>Prozessor</b>	Übergangsfrequenz:	800 Hz
	Schutzschaltungen:	Thermal, RMS
	Limiter:	Soft Limiter
	Steuerung:	Volume, EQ Shape, Mlc/Line
<b>Power Section</b>	Gesamtleistung:	1400 W Peak, 700 W RMS
	Tiefe Frequenzen:	1000 W Peak, 500 W RMS
	Kühlung:	Convection
	Verbindungen:	Powercon IN/OUT
<b>Standardkonformität</b>	CE Zeichen:	Yes
<b>Physikalische Daten</b>	Gehäuse Material:	Baltic birch plywood
	Hardware:	4 x MB, 4 x quick lock
	Griffe:	2 side
	Pole Mount/Cap:	Yes
	Gitter:	Steel
	Farbe:	Black
<b>Größe</b>	Höhe:	1056 mm / 41.57 inches
	Breite:	201 mm / 7.91 inches
	Tiefe:	274 mm / 10.79 inches
	Gewicht:	26.4 kg / 58.2 lbs
<b>Versandinformationen</b>	Verpackung Höhe:	316 mm / 12.44 inches
	Verpackung Breite:	1155 mm / 45.47 inches
	Verpackung Tiefe:	222 mm / 8.74 inches
	Verpackungsgewicht:	29 kg / 63.93 lbs



**ARTIKEL-NUMMER**

• **13000400**

NXL 24-A

115V

EAN 8024530010812

• **13000399**

NXL 24-A

220-240V

EAN 8024530010805

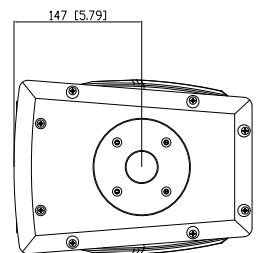
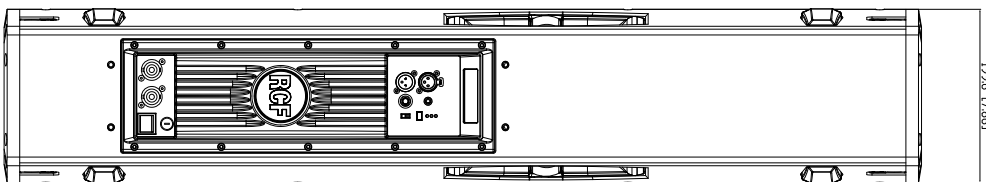
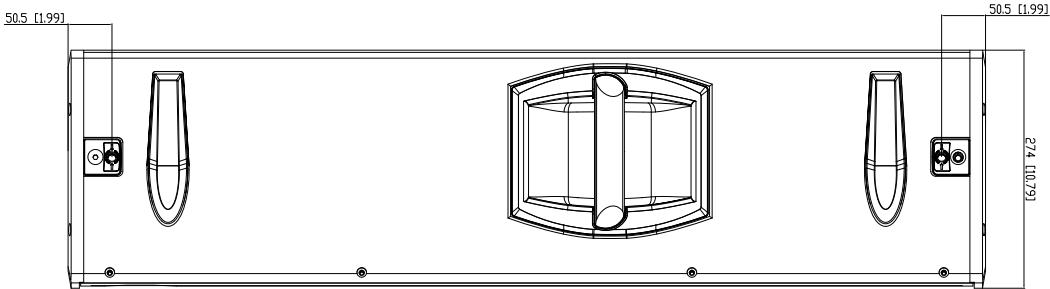
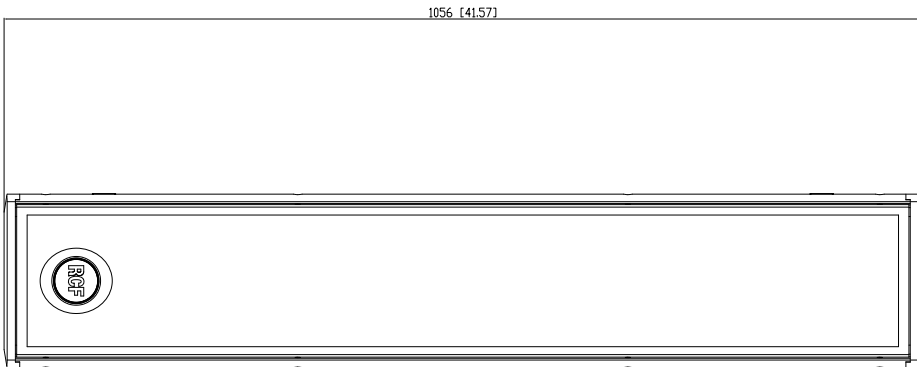
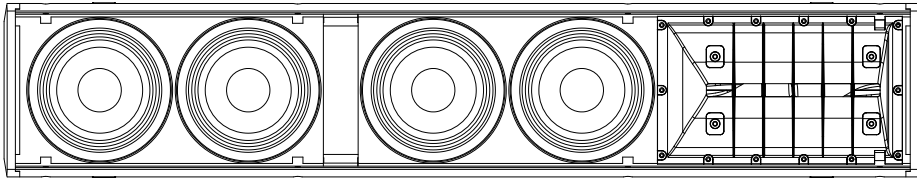

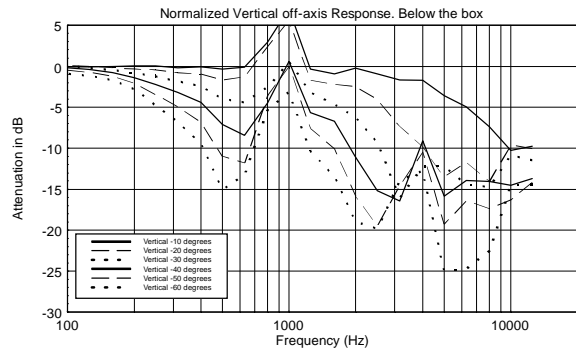
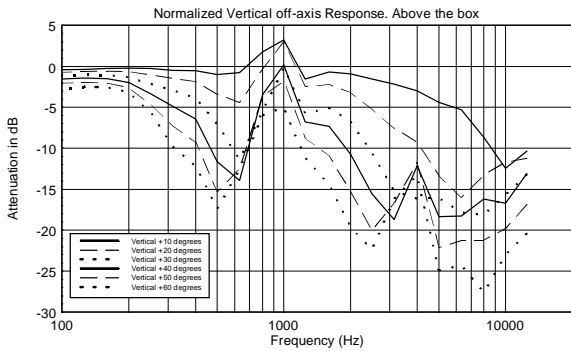
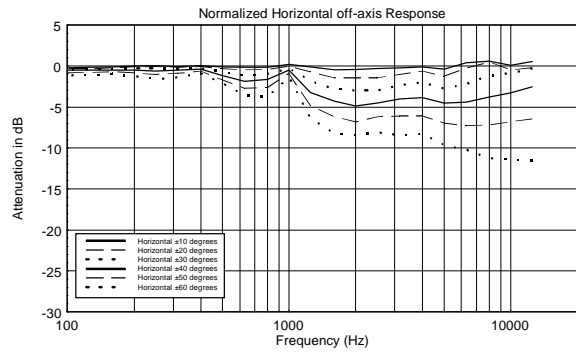
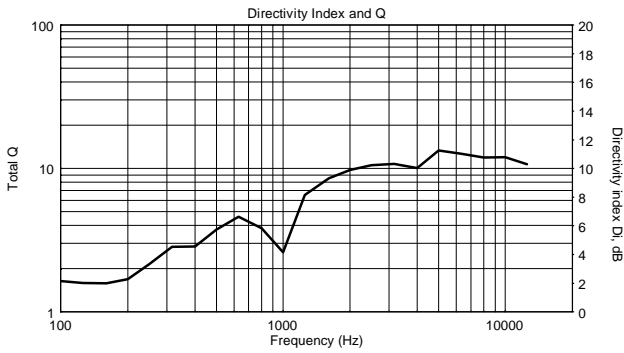
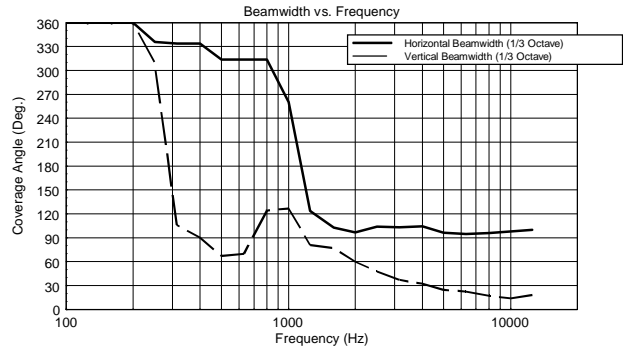
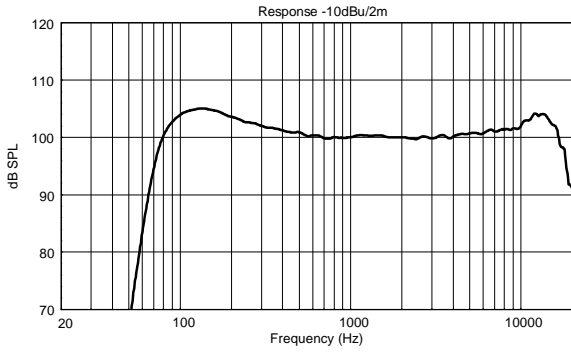

Horizontal 1/3 Octave Polars

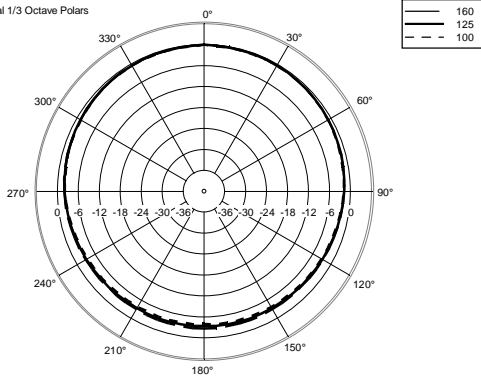

Horizontal 1/3 Octave Polars

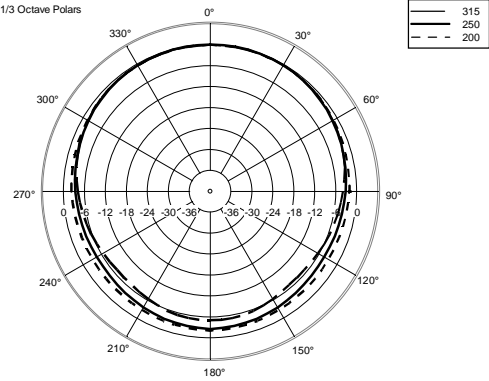

Horizontal 1/3 Octave Polars

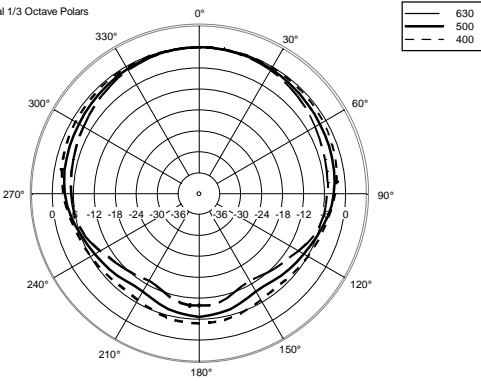

Horizontal 1/3 Octave Polars

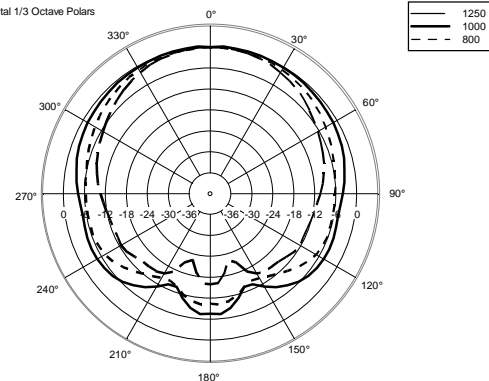

Horizontal 1/3 Octave Polars

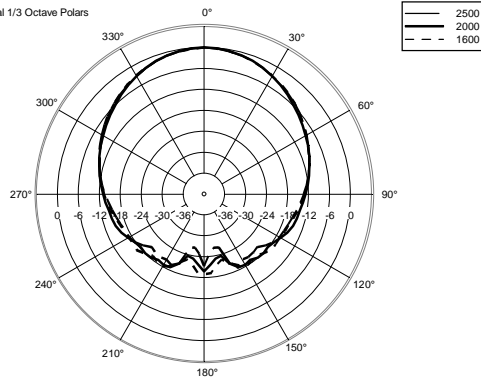

Horizontal 1/3 Octave Polars

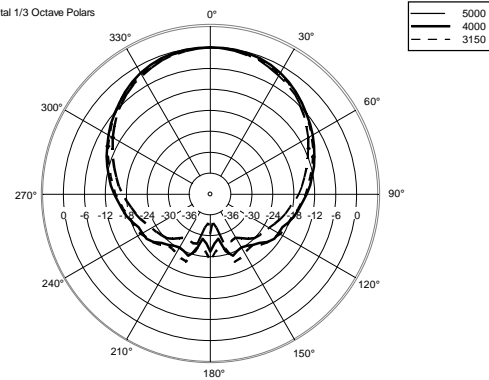

Horizontal 1/3 Octave Polars

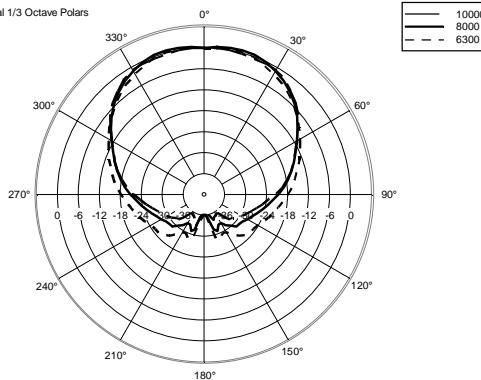

Horizontal One Octave Polars

