

TTL 55-A

ACTIVE THREE-WAY LINE ARRAY MODULE

DESCRIPTION

The TTL55-A is a high power, three way, active line array module engineered to deliver an incredible output for use in indoor or outdoor large spaces. The system is designed to be easily scalable from few modules for medium and small theatres to full size arrays for very large outdoor stadia and public spaces. The three new designs for the six neodymium transducers that power the system represent the result of many years dedicated in pioneering new solutions using the best materials available on the market. The integration of the 3500 W four channel digital amplification and the advanced digital processing set a new standard for distortion, noise and thermal efficiency.



FEATURES

- Tour grade cabinet and mechanics
- 3500 Watt, 4 way amplification
- 6 x high power neodymium transducers
- High quality analog input board
- 96 kHz, 32 bit DSP processing
- Remote monitoring and control
- Maximum output per size on the market
- RDNet on board

TECHNICAL SPECIFICATIONS

Acoustical specifications	Frequency Response:	50 Hz ÷ 20000 Hz
	Max SPL @ 1m:	143 dB
	Horizontal coverage angle:	90°
	Vertical coverage angle:	7°
Transducers	Compression Driver:	3 x 1.5" neo, 2.5" v.c
	Midrange:	10" neo, 3.5" v.c
	Woofers:	2 x 12" neo, 4.0" v.c
Input/Output section	Input signal:	bal/unbal
	Input connectors:	XLR, RDNet Ethercon
	Output connectors:	XLR, RDNet Ethercon
	Input sensitivity:	+4 dBu
Processor section	Crossover Frequencies:	320 Hz - 1300 Hz
	Protections:	Thermal, Excurs., RMS
	Limiter:	Soft Limiter
	Controls:	DSP controlled
	RDNet:	Yes
Power section	Total Power:	7000 W Peak, 3500 W RMS
	High frequencies:	1000 W Peak, 500 W RMS
	Mid frequencies:	2000 W Peak, 1000 W RMS
	Low frequencies:	4000 W Peak, 2000 W RMS
	Cooling:	Convection/Forced
	Connections:	Powercon IN/OUT
Standard compliance	CE marking:	Yes
Physical specifications	Cabinet/Case Material:	Baltic birch plywood
	Hardware:	Array Fly - Ware
	Handles:	2 Side
	Grille:	Steel
	Color:	Black
Size	Height:	380 mm / 14.96 inches
	Width:	1020 mm / 40.16 inches
	Depth:	550 mm / 21.65 inches
	Weight:	70.5 kg / 155.43 lbs
Shipping informations	Package Height:	909 mm / 35.79 inches
	Package Width:	1144 mm / 45.04 inches
	Package Depth:	499 mm / 19.65 inches
	Package Weight:	81 kg / 178.57 lbs



PART NUMBER

• **13000189**

TTL 55-A

115V

EAN 8024530008604

• **13000188**

TTL 55-A

220-240V

EAN 8024530008598

360

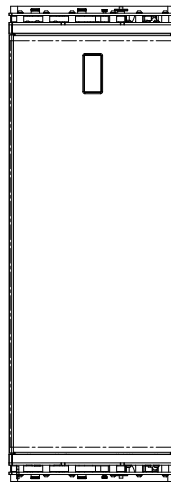
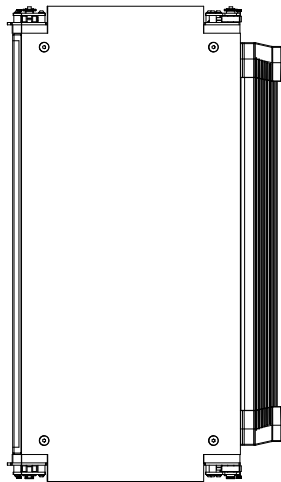
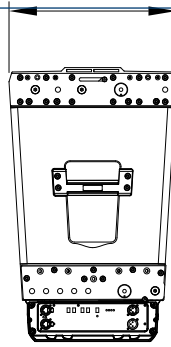

1022.5

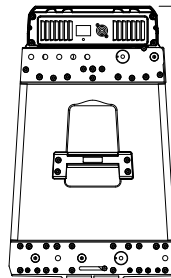

589.5

TTL 55-A

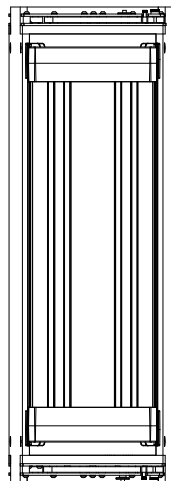

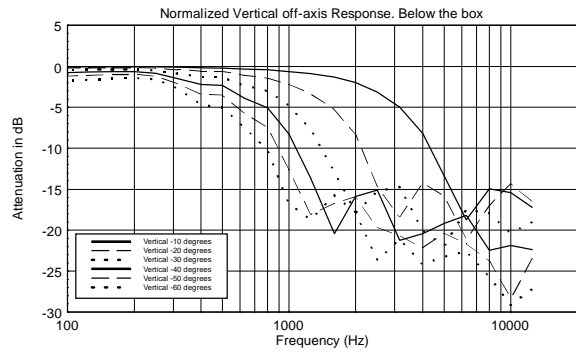
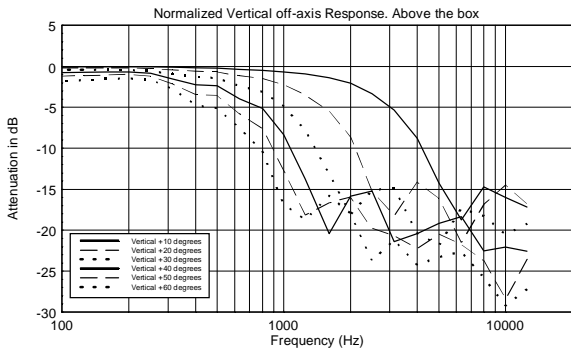
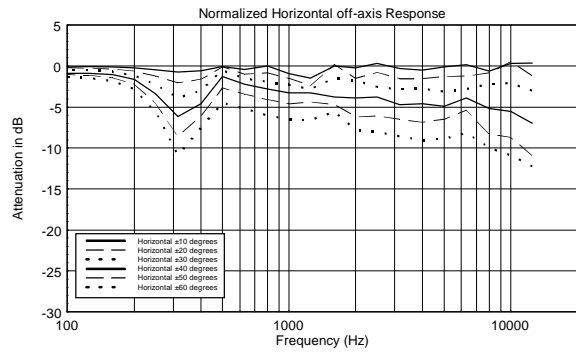
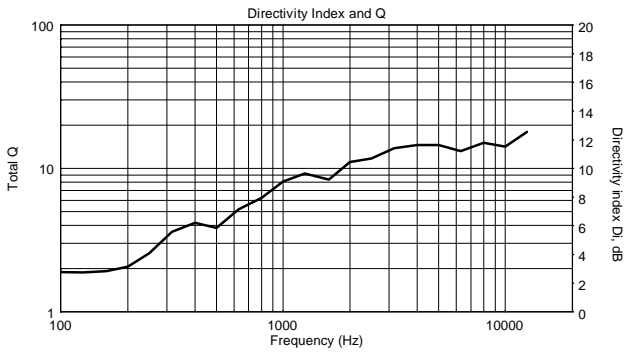
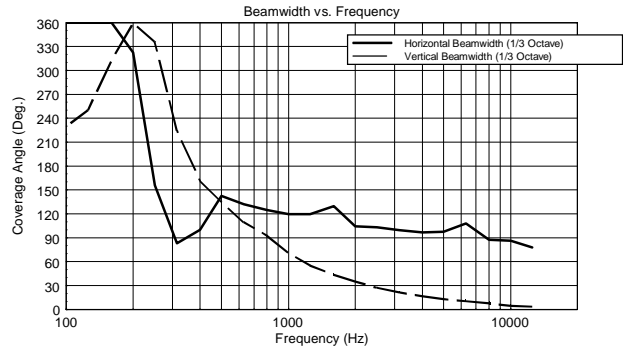
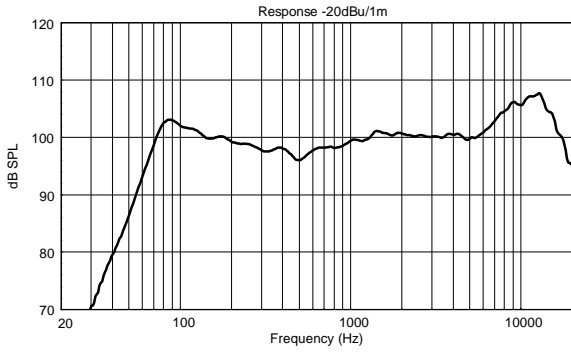

Horizontal 1/3 Octave Polars

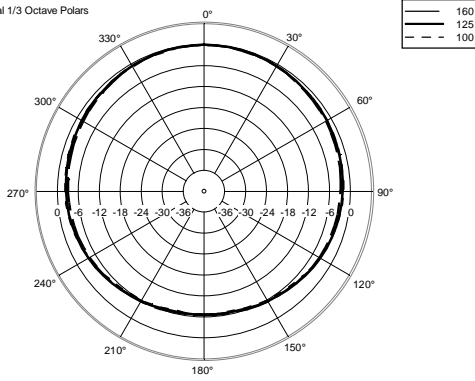

Horizontal 1/3 Octave Polars

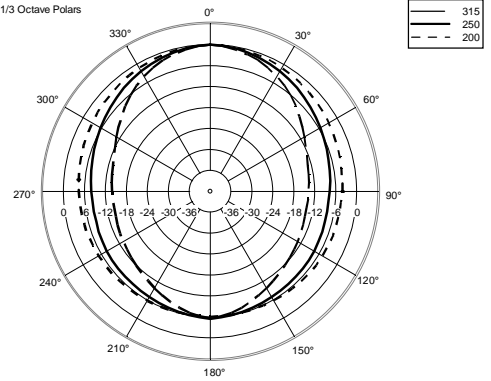

Horizontal 1/3 Octave Polars

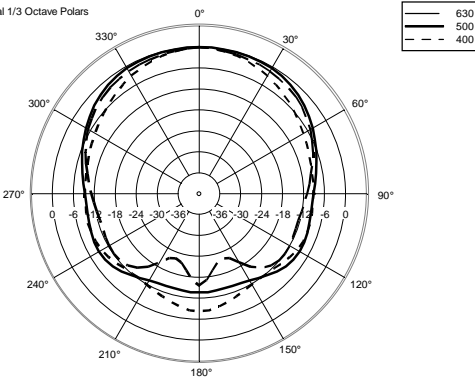

Horizontal 1/3 Octave Polars

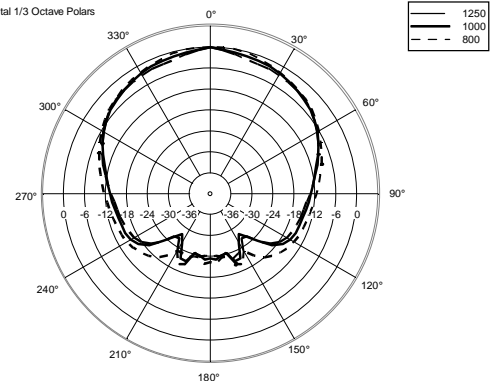

Horizontal 1/3 Octave Polars

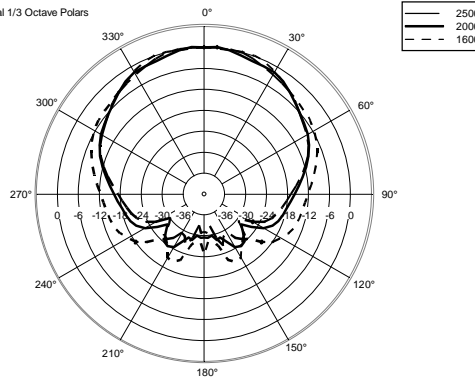

Horizontal 1/3 Octave Polars

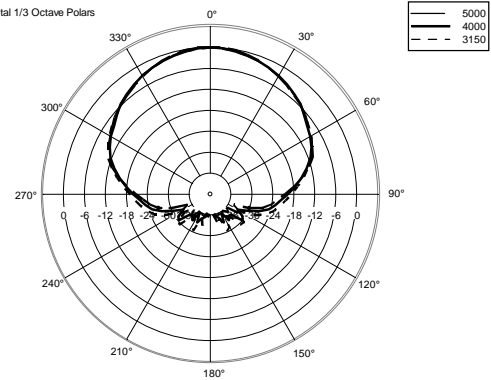

Horizontal 1/3 Octave Polars

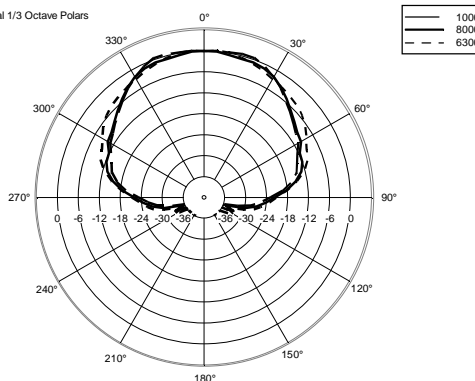

Horizontal One Octave Polars

