

# HD 6045EN

## LONG-THROW MULTI CELL HORN SPEAKER

### DESCRIPTION

HD 6045EN is a fiberglass horn designed to withstand the most adverse weather conditions, offering high sound reproduction quality and sound pressure levels. A high level of efficiency and sound pressure can be obtained thanks to the use of 4 dynamic driver units for a total output power of 200W. Internal transformers for 100V/70V constant voltage systems are equipped with ceramic terminal blocks for input and output flameproof cables and thermal switch. HD 6045EN is complying with EN 54-24 standard.



### FEATURES

- Long-throw horn speaker
- Body in RAL 9003 white fiberglass
- Mounting bracket
- Mounting bracket Protection grade IP55
- 4 x 50W drivers with transformers for constant voltage line

## TECHNICAL SPECIFICATIONS

<b>Acoustical specifications</b>	Frequency Response (-10dB):	200 Hz ÷ 10000 Hz
	Max SPL @ 1m:	124 dB
	Max SPL @ 4m:	112 dB
	Horizontal coverage angle:	60°
	Vertical coverage angle:	50°
	System Sensitivity:	101 dB
	System Sensitivity 1W @ 4m:	89 dB
<b>Power section</b>	Power Handling:	200 W RMS
	Peak Power Handling:	800 W PEAK
	Recommended Amplifier:	400 W
	Protections:	Thermal fuse
<b>Transducers</b>	Compression Driver:	2.0"
<b>Input/Output section</b>	Input connectors:	Ceramic screw terminals
	Output connectors:	Ceramic screw terminals
	Constant Voltage Transformer:	100 V
	Power selection 1 (100 V):	200 W - 50 ohm
<b>Standard compliance</b>	IP protection grade:	IP 65
	EN54-24 certified:	Yes
	CE marking:	Yes
	CPR number:	0068-CPR-030/2015
<b>Physical specifications</b>	Cabinet/Case Material:	Fiberglass
	Color:	White - RAL 9003
<b>Size</b>	Height:	475 mm / 18.7 inches
	Width:	620 mm / 24.41 inches
	Depth:	564 mm / 22.2 inches
	Weight:	10.5 kg / 23.15 lbs
<b>Shipping informations</b>	Package Height:	615 mm / 24.21 inches
	Package Width:	645 mm / 25.39 inches
	Package Depth:	495 mm / 19.49 inches
	Package Weight:	13.5 kg / 29.76 lbs

## PART NUMBER

- **13133085**

HD 6045EN

**DRAWINGS**

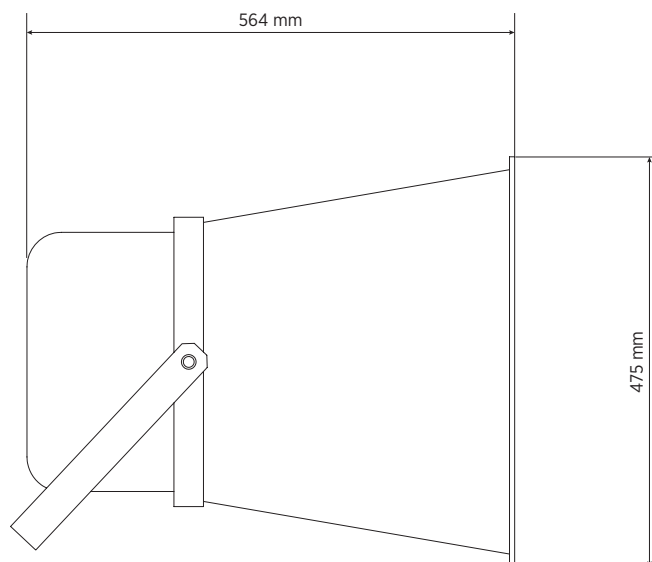
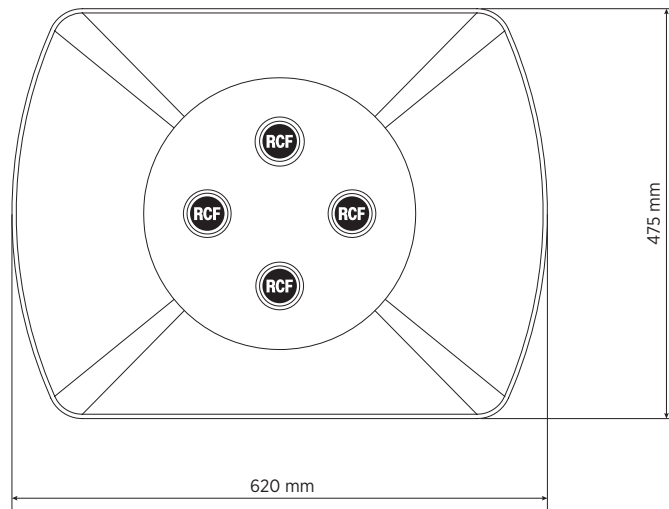

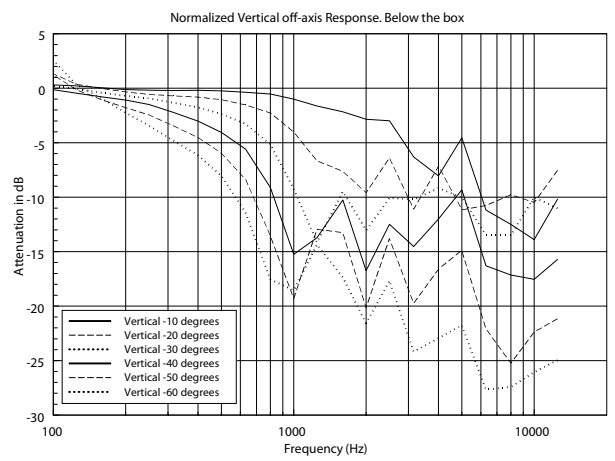
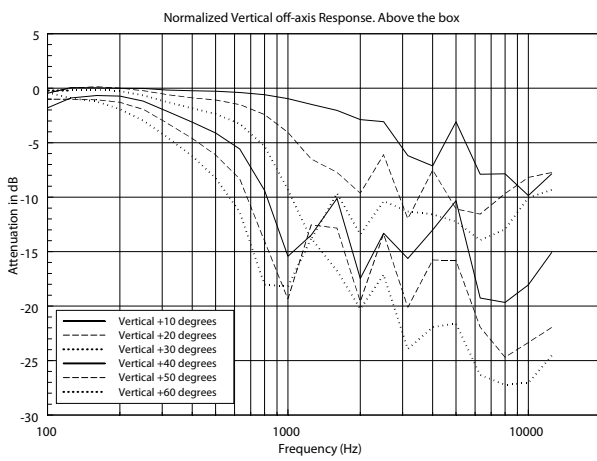
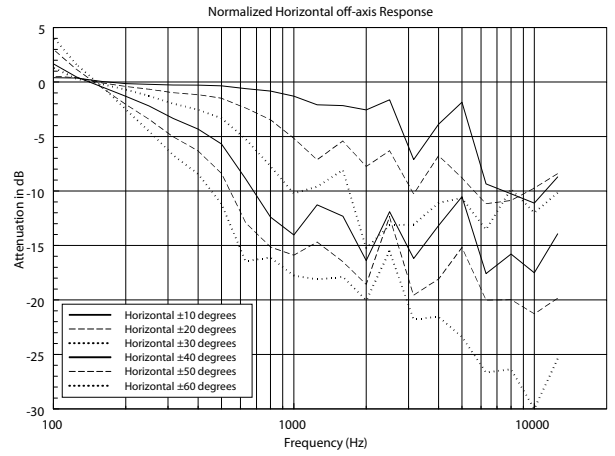
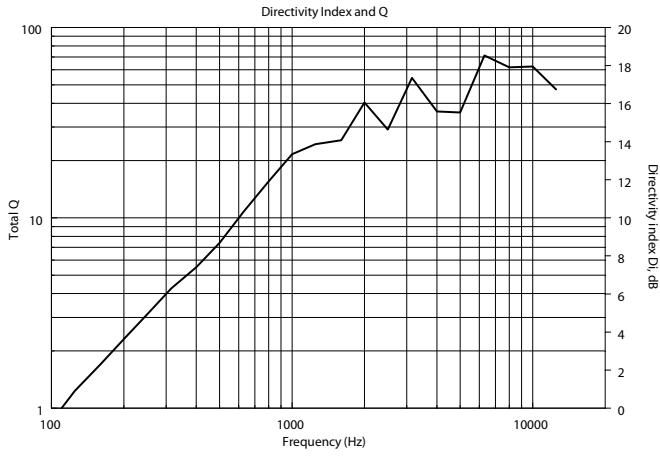
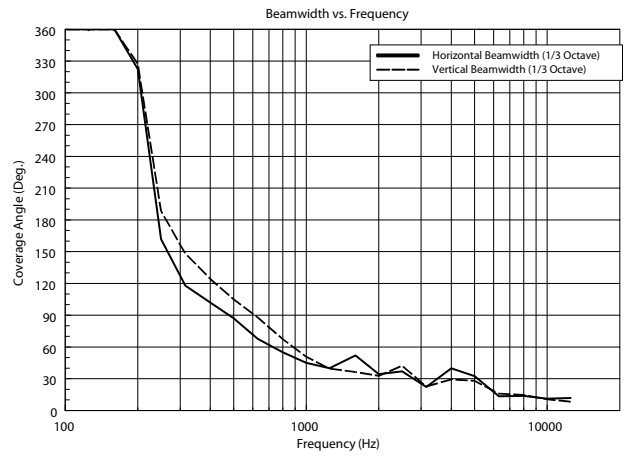
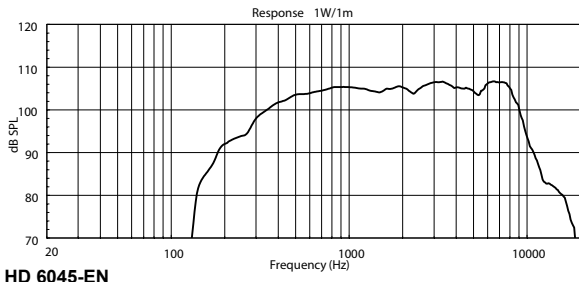

HORIZONTAL 1/3 POLAR PLOT

Horizontal 1/3 Octave Polars

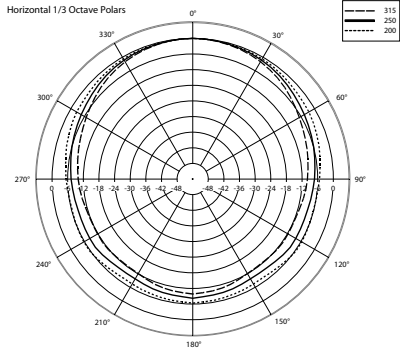

Horizontal 1/3 Octave Polars

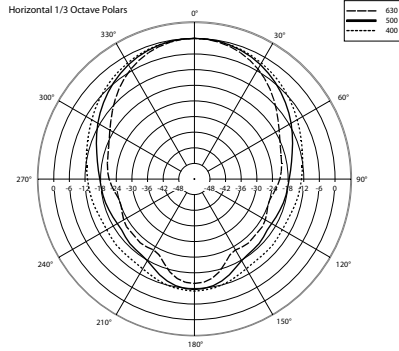

Horizontal 1/3 Octave Polars

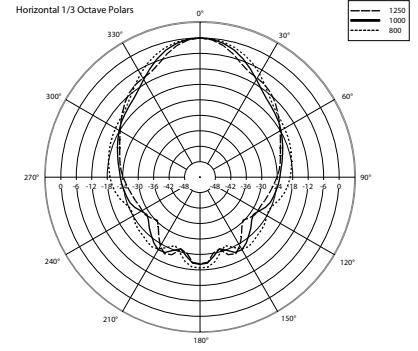

Horizontal 1/3 Octave Polars

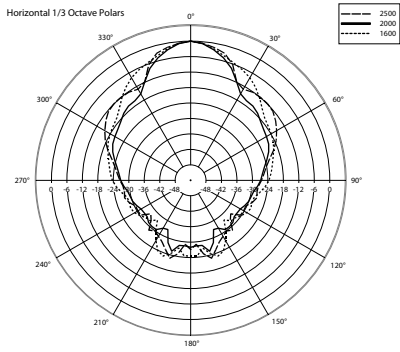

Horizontal 1/3 Octave Polars

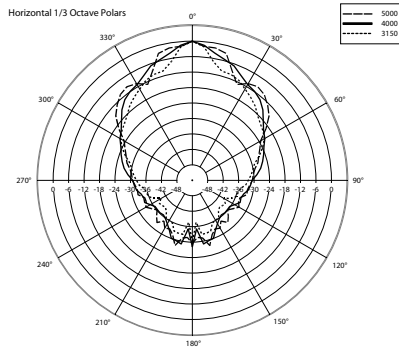

Horizontal 1/3 Octave Polars

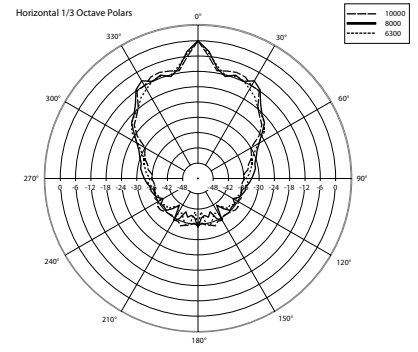

VERTICAL 1/3 POLAR PLOT

Vertical 1/3 Octave Polars

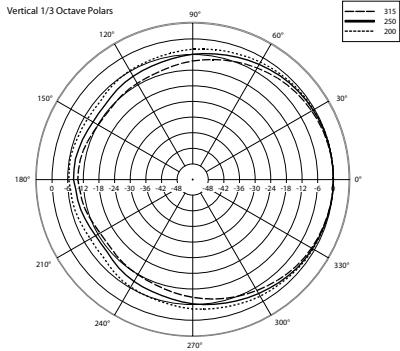

Vertical 1/3 Octave Polars

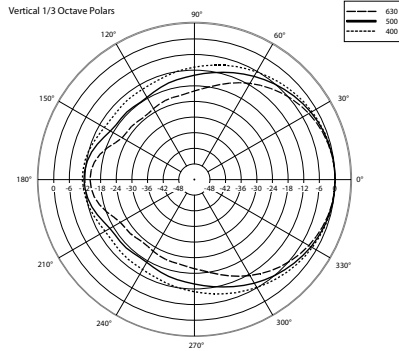

Vertical 1/3 Octave Polars

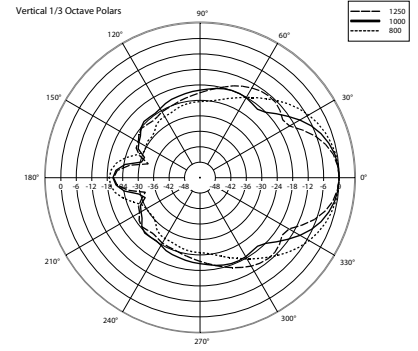

Vertical 1/3 Octave Polars

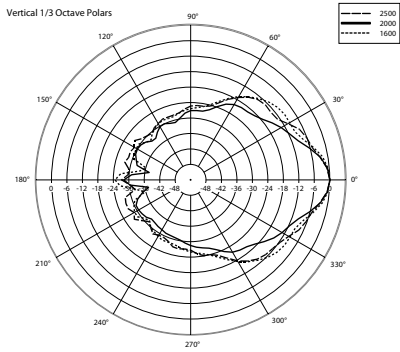

Vertical 1/3 Octave Polars

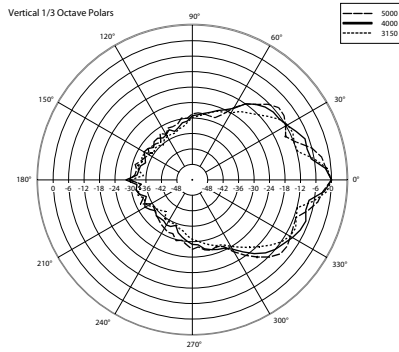

Vertical 1/3 Octave Polars

