

ø 465 mm

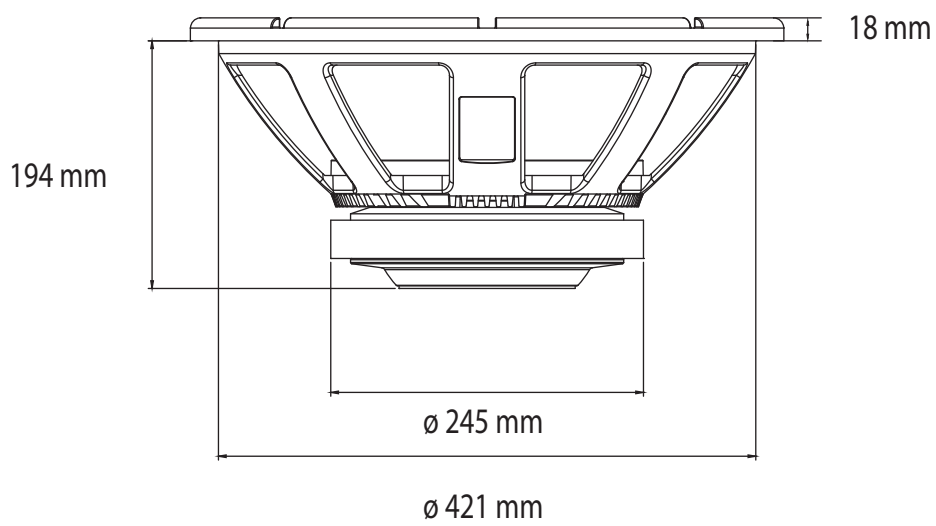

194 mm

18 mm

ø 245 mm

ø 421 mm