



MXR 4500

RACK MOUNT AMPLIFIED MASTER UNIT

CONTENTS

CONTENTS	3
SAFETY PRECAUTIONS AND GENERAL INFORMATION	5
DXT 4000 SYSTEM DESCRIPTION	9
UNPACKING, INSTALLATION AND COOLING.....	11
CONFIGURATION EXAMPLES	12
MAIN BOARD	13
MESSAGES SD CARD BOARD	21
INTERLINK BOARD.....	23
SPARE AMPLIFIER SETTING.....	26
BATTERIES CONNECTION	27
LOUDSPEAKERS CONNECTION	29
FIRE ALARM SYSTEM MONITORING.....	34
START UP PROCEDURE	35
FRONT PANEL BOARD	36
FRONT PANEL	37
PARAMETER LIST.....	39
DIMENSIONS	45
SPECIFICATIONS.....	46



ATTENTION

CAUTION

RISK OF ELECTRIC SHOCK

DO NOT OPEN



CAUTION

WARNING: SHOCK HAZARD – DO NOT OPEN

ATTENTION: RISQUE D'ÉLECTROCUTION - NE PAS OUVRIR

WARNING: TO REDUCE THE RISK OF FIRE OR ELECTRIC SHOCK DO NOT EXPOSE THIS EQUIPMENT TO RAIN OR MOISTURE

ATTENTION: NE PAS EXPOSER CE MATÉRIEL À LA PLUIE OU L'HUMIDITE AFIN DE REDUIRE LE RISQUE D'INFLAMMATION OU DE CHOC ÉLECTRIQUE







PROTECTING EARTHING TERMINAL. THE APPARATUS SHOULD BE CONNECTED TO A MAINS SOCKET WITH A PROTECTIVE EARTH CONNECTION.

RCF S.p.A. thanks you for purchasing this product, which has been designed to guarantee reliability and high performance.

SAFETY PRECAUTIONS AND GENERAL INFORMATION

Symbols used in this document give notice of important operating instructions and warnings which must be strictly followed.

	CAUTION	Important operating instructions: explains hazards that could damage a product, including data loss
	WARNING	Important advice concerning the use of dangerous voltages and the potential risk of electric shock, personal injury or death.
	IMPORTANT NOTES	Helpful and relevant information about the topic
	SUPPORTS, TROLLEYS AND CARTS	Information about the use of supports, trolleys and carts. Reminds to move with extreme caution and never tilt.
	WASTE DISPOSAL	This symbol indicates that this product should not be disposed with your household waste, according to the WEEE directive (2012/19/EU) and your national law.

IMPORTANT NOTES

This manual contains important information about the correct and safe use of the device. Before connecting and using this product, please read this instruction manual carefully and keep it on hand for future reference. The manual is to be considered an integral part of this product and must accompany it when it changes ownership as a reference for correct installation and use as well as for the safety precautions. RCF S.p.A. will not assume any responsibility for the incorrect installation and / or use of this product.

SAFETY PRECAUTIONS

1. All the precautions, in particular the safety ones, must be read with special attention, as they provide important information.
2. This is a professional product. Its use is reserved to instructed persons, in relation to the connected risks.
3. Power supply from mains:
 - a. The mains voltage is sufficiently high to involve a risk of electrocution; install and connect this product before plugging it in.
 - b. Before powering up, make sure that all the connections have been made correctly and the voltage of your mains corresponds to the voltage shown on the rating plate on the unit, if not, please contact your RCF dealer.
 - c. The metallic parts of the unit are earthed through the power cable. An apparatus with CLASS I construction shall be connected to a mains socket outlet with a protective earthing connection.
 - d. Protect the power cable from damage; make sure it is positioned in a way that it cannot be stepped on or crushed by objects.
 - e. To prevent the risk of electric shock, never open this product: there are no parts inside that the user needs to access.

- f. Be careful: in the case of a product supplied by manufacturer only with POWERCON connectors and without a power cord, all power cords and plug assemblies shall be in compliance with the requirements of the IEC 62368-1 and certified and suitable for use in the particular countries where the product shall be installed.
4. Make sure that no objects or liquids can get into this product, as this may cause a short circuit. This apparatus shall not be exposed to dripping or splashing. No objects filled with liquid, such as vases, shall be placed on this apparatus. No naked sources (such as lighted candles) should be placed on this apparatus.
 5. Never attempt to carry out any operations, modifications or repairs that are not expressly described in this manual. Contact your authorized service centre or qualified personnel should any of the following occur:
 - The product does not function (or functions in an anomalous way).
 - The power cable has been damaged.
 - Objects or liquids have got in the unit.
 - The product has been subject to a heavy impact.
 6. This product does not contain user replaceable fuses. Fuses replacement is a service operation and must be performed by qualified personnel.
 7. If this product is not used for a long period, disconnect the power cable.
 8. If this product begins emitting any strange odours or smoke, switch it off immediately and disconnect the power cable.
 9. Do not connect this product to any equipment or accessories not foreseen. For suspended installation, only use the dedicated anchoring points and do not try to hang this product by using elements that are unsuitable or not specific for this purpose. Also check the suitability of the support surface to which the product is anchored (wall, ceiling, structure, etc.), and the components used for attachment (screw anchors, screws, brackets not supplied by RCF etc.), which must guarantee the security of the system / installation over time, also considering, for example, the mechanical vibrations normally generated by transducers. To prevent the risk of falling equipment, do not stack multiple units of this product unless this possibility is specified in the user manual.
 10. **RCF S.p.A. strongly recommends this product is only installed by professional qualified installers (or specialised firms) who can ensure correct installation and certify it according to the regulations in force. The entire audio system must comply with the current standards and regulations regarding electrical systems.**
 11. Supports, trolleys and carts.



The equipment should be only used on supports, trolleys and carts, where necessary, that are recommended by the manufacturer. The equipment / support / trolley / cart assembly must be moved with extreme caution. Sudden stops, excessive pushing force and uneven floors may cause the assembly to overturn. Never tilt the assembly.

12. There are numerous mechanical and electrical factors to be considered when installing a professional audio system (in addition to those which are strictly acoustic, such as sound pressure, angles of coverage, frequency response, etc.).
13. Hearing loss. Exposure to high sound levels can cause permanent hearing loss. The acoustic pressure level that leads to hearing loss is different from person to person and depends on the duration of exposure. To prevent potentially dangerous exposure to high levels of acoustic pressure, anyone who is exposed to these levels should use adequate protection devices. When a transducer capable of producing high sound levels is being used, it is therefore necessary to wear ear plugs or protective earphones. See the manual technical specifications to know the maximum sound pressure level.

OPERATING PRECAUTIONS

- Place this product far from any heat sources and always ensure an adequate air circulation around it.
- Do not overload this product for a long time.
- Never force the control elements (keys, knobs, etc.).

- Do not use solvents, alcohol, benzene or other volatile substances for cleaning the external parts of this product.



IMPORTANT NOTES

To prevent the occurrence of noise on line signal cables, use screened cables only and avoid putting them close to:

- **Equipment that produces high-intensity electromagnetic fields**
- **Power cables**
- **Loudspeaker lines**



WARNING! CAUTION! To prevent the risk of fire or electric shock, never expose this product to rain or humidity.



WARNING! to reduce the risk of electric shock, do not disassemble this product unless you are qualified. Refer servicing to qualified service personnel.

CORRECT DISPOSAL OF THIS PRODUCT



This product should be handed over to an authorized collection site for recycling waste electrical and electronic equipment (EEE). Improper handling of this type of waste could have a possible negative impact on the environment and human health due to potentially hazardous substances that are generally associated with EEE. At the same time, your cooperation in the correct disposal of this product will contribute to the effective usage of natural resources. For more information about where you can drop off your waste equipment for recycling, please contact your local city office, waste authority or your household waste disposal service.

CARE AND MAINTENANCE

To ensure a long-life service, this product should be used following these advices:

- If the product is intended to be set up outdoors, be sure it is under cover and protected to rain and moisture.
- Always use a dry cloth to clean the exterior surfaces of the speaker and always do it when the power is turned off.



CAUTION: to avoid damaging the exterior finishes do not use cleaning solvents or abrasives.

FCC NOTES

This equipment has been tested and found to comply with the limits for a Class A digital device, pursuant to Part 15 of the FCC Rules. These limits are designed to provide reasonable protection against harmful interference when the equipment is operated in a commercial environment. This equipment generates, uses, and can radiate radio frequency energy, and if it is not installed and used in accordance with the instruction manual, it may cause harmful interference to radio communications. Operation of this equipment in a residential area is likely to cause harmful interference, in which case the user will be required to correct the interference at his own expense.

Modifications: Any modifications made to this device that are not approved by RCF may void the authority granted to the user by the FCC to operate this equipment.

RCF S.p.A. reserves the right to make changes without prior notice to rectify any errors and / or omissions. Always refer to the latest version of the manual on www.rcf.it.



IMPORTANT: this manual is for only trained and qualified personnel for installation and maintenance of the system.

DXT 4000 SYSTEM DESCRIPTION

DXT 4000 is a voice alarm system in compliance with EN 54-16 ('Fire detection and fire alarm systems', part 16: 'Voice alarm control and indicating equipment') and EN 54-4 (Part 4: 'Power supply equipment').

It is suitable for emergency announcements, paging and background music, in small-size environments.

Connections are simple and its use is easy and immediate.

Its settings are user definable, but its emergency functions, which shall meet all system requirements and its installation (UNI ISO 7240-19).

MXR 4500 is the main unit with a metallic enclosure for rack-mounting into a 19" rack cabinet (4 units), and it has all necessary components inside for the system operating, included a digital sound processor (DSP) that allows a proper equalization.

Every MXR 4500 main unit has:

- An audio input for a line made of up to four monitored BM 3804 paging microphones for selective announcements (linked in 'daisy-chain', with or without additional BE 3806 keyboards, according to the max. number of zones).
- An AUX audio input mainly used for a line made of one or more BM 3022 paging microphones (not monitored and linked in 'daisy-chain') for general calls only. This input has also the VOX automatic priority (if enabled in the display menu) when an audio signal is detected.
- An audio input for a background music source (i.e. MP3 / CD players, tuners, etc.).
- Logic inputs and outputs to interface to the fire alarm system (or others).
- An internal player of pre-recorded messages stored on monitored SD CARD.
- A simple MP3 player on its front panel, with an additional AUX IN (1/8" jack) for external audio sources.
- An internal slot for the INTERLINK board (optional), necessary to link more main units one another.

Each MXR 4500 main unit can be delivered with either two or (on request) four / six built-in RCF class D+ power amplifiers (according to the needs), in order to have either two or four / six zones.

Thanks to its internal digital matrix, each power amplifier can send to its zone a different signal (among all the available, e.g. emergency / routine announcements, pre-recorded messages, background music).

The last available amplifier (the second or the fourth or the sixth) can be alternatively used as spare (with automatic change-over).

The total maximum output power (sum of all zones) is 500 W and freely assignable within the limit of 250 W per each zone (power that corresponds to either a 40 Ω load at 100 V or a 20 Ω load at 70 V).

Amplifier outputs are for 100 V / 70 V constant voltage speaker lines.

Each zone has two outputs (to get redundant lines).

MXR 4500 main unit has a backup power supply that meets the EN 54-4 standard, with recharging unit and check of batteries (18 Ah).

To ensure a full system efficiency, it is strongly advised to check batteries every two years and replace them if necessary.

Electronically, the system is composed of:

- Main board
- Power supply board (EN 54-4:2007 compliant)
- 1, 2 or 3 amplifier boards, each having 2 amplifiers (total max. output power: 500 W)
- MP3 audio player
- Message player board with monitored SD CARD

DXT 4000 SYSTEM PAGING MICROPHONES

BM 3804

Monitored and preamplified desk-top paging microphone, with gooseneck and electret capsule, for selective calls on different zones selected through its keyboard.

Up to four BM 3500 paging microphones (interlocked one another) can be linked in 'daisy-chain' (and directly connected to the MXR 4500 main unit).

The total cable length (CAT 6 FTP or J-type) cannot exceed 1 km.

BE 3806

Additional keyboard for BM 3804 paging microphones, with six pre-configured keys.

A single BM 3804 paging microphone can be expanded with maximum six BE 3806 additional keyboards (up to total maximum of 67 keys in the system).

BM 3022

Preamplified desk-top paging microphone, with gooseneck and electret capsule, for general calls only. Up to thirty BM 3022 paging microphones can be linked in 'daisychain' (in a single line) and used either in mixing (more microphones turned on simultaneously) or in lock mode (only a microphone activated at a time).

UNPACKING, INSTALLATION AND COOLING

Check the carton box and its contents and if there is any sign of damage (should the amplifier be damaged, immediately inform your local distributor / dealer and the forwarder).

It is always advisable to keep the packing materials, even if the amplifier has arrived in good condition. The power cord is included.

The main unit MXR 4500 shall be placed in a closed environment, within a protected area not subjected to conditions that may affect its operation, for example: moisture, salt, water infiltration, extreme temperatures, shocks, etc.

MXR 4500 master unit shall be installed into a 19" rack cabinet (4 units) leaving 1 empty unit between other units, in order to guarantee the air flow necessary for an effective thermal dissipation.

Moreover, it shall not be installed in a place with:

- too high temperature, dust or excessive humidity;
- exhaust air ventilators;
- permanent vibrations;
- high-intensity electromagnetic fields (due to transformers, transmitters, etc.).

Make sure there is an adequate ventilation and amplifiers sides have enough room.

The temperature inside the rack cabinet should be kept below 35°C (95°F).

Audio signal cables, speaker lines and power cords shall be kept separate from one another.



For safety reasons, never disconnect the earth (ground) pin of the mains power cord. Use audio shielded cables to avoid hum and interference.

CONFIGURATION EXAMPLES

A basic configuration (for instance, including a MXR 4500/2 main unit, a BM 3804 paging microphone and, eventually, an additional optional external music source) is suitable for a system with either a single zone or two, in which the total speaker power does not exceed 500 W (max. 250 W per zone, in any proportion on the two speaker lines A, B). Several logic inputs / outputs are available to get DXT 4000 interfaced to the fire alarm system (or others). In case of a single-zone system, the second amplifier is used as spare (with automatic change-over).

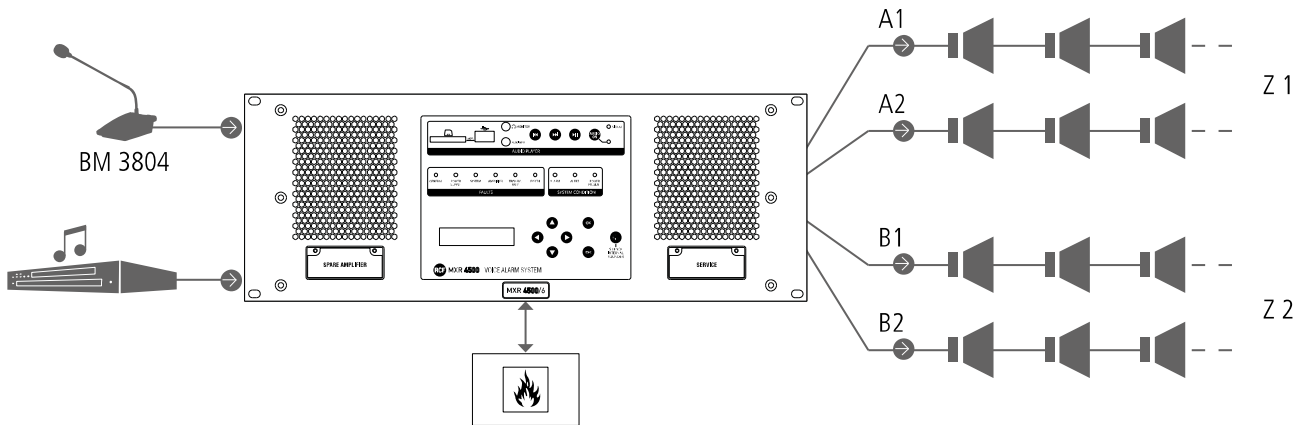

On request, the main unit can be delivered with four (MXR 4500/4) / six (MXR 4500/6) built-in power amplifiers.

The overall power is always 500 W and it can be freely shared among the four / six zones (within the limit of max. 250 W per zone, power that corresponds to either a 40 Ω load at 100 V or a 20 Ω load at 70 V).

The last amplifier (the fourth or the sixth) can be alternatively used as spare (with automatic change-over).

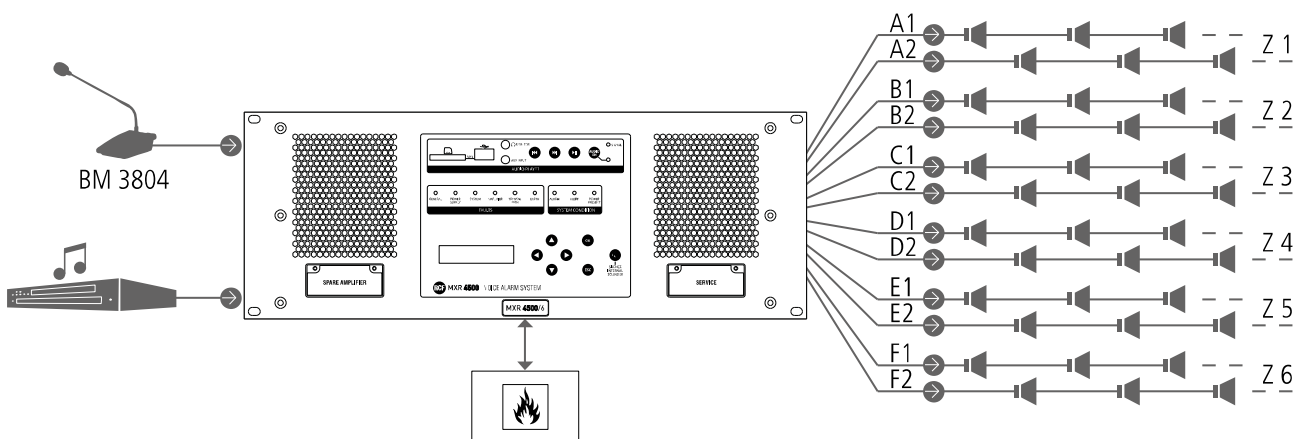

MAIN BOARD

The main board is the system control unit and linked to all the other boards.

It can be accessed by loosening the screws [A] on the back of the unit and then removing the cover [B].

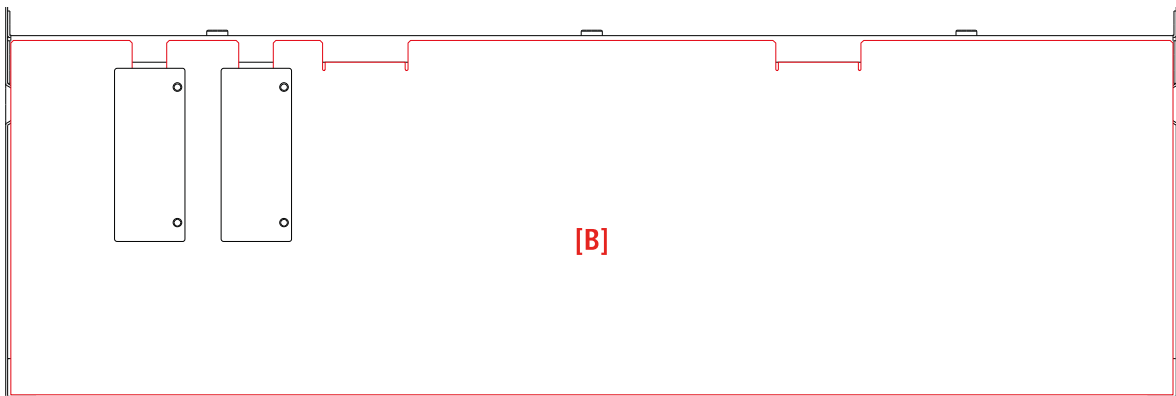
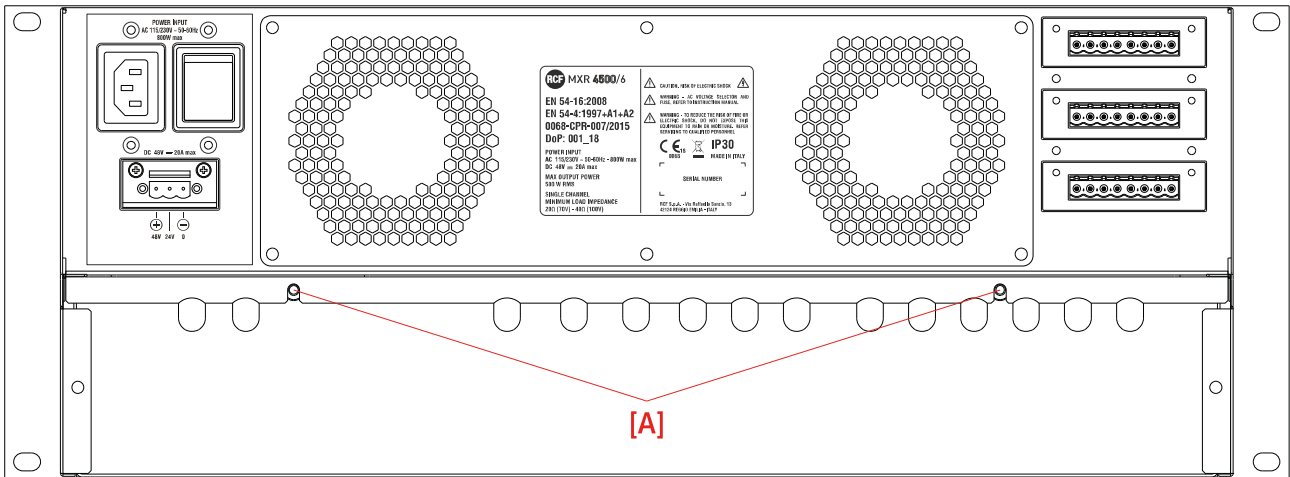

Once removed the cover, system's connections and settings will be available.

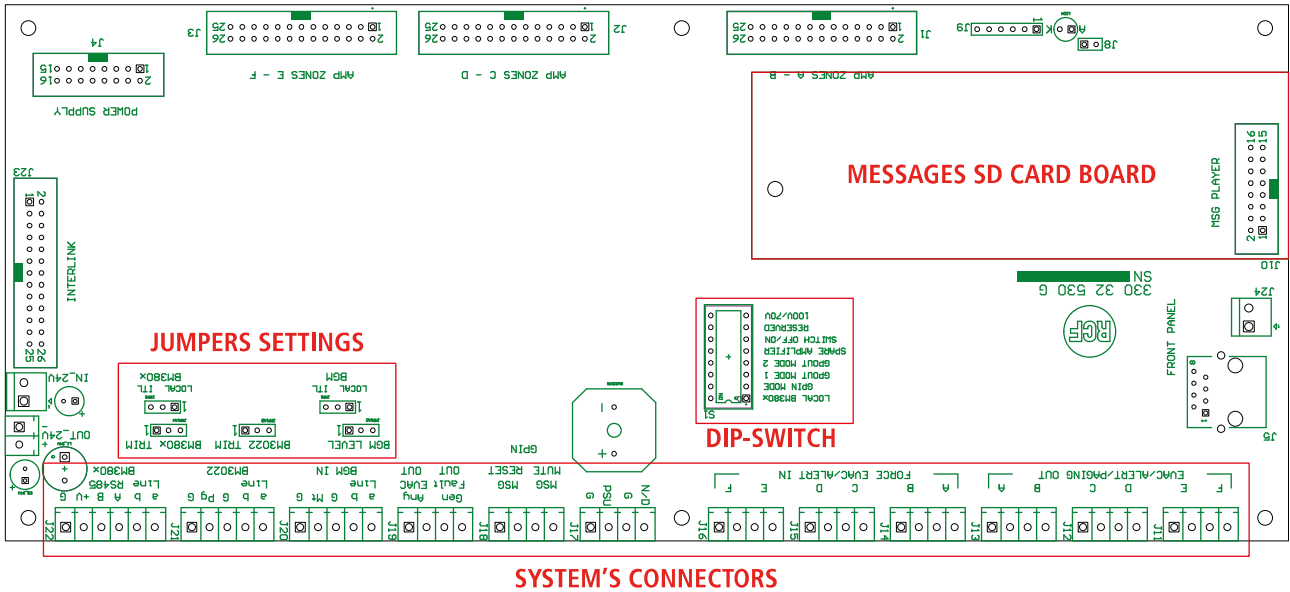

SYSTEM'S CONNECTORS

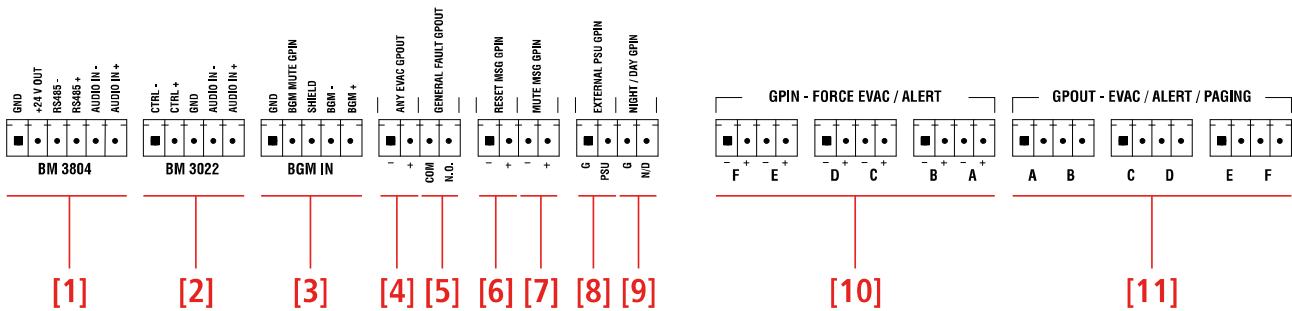

[1] Input for monitored paging microphones with emergency purposes (e.g. **BM 3804**).

PIN	DESCRIPTION	BM 3804 CABLE – WIRE COLOUR
+	Audio signal (+, hot)	Orange/White (RJ pin 1)
-	Audio signal (-, cold)	Orange (RJ pin 2)
A	Serial port RS 485 A (+)	Brown/White (RJ pin 7)
B	Serial port RS 485 B (-)	Brown (RJ pin 8)
+V	+ 24 V dc power supply	Green/White (RJ pin 3)
G	Ground	Blue, White/Blue, Green (RJ pins 4-5-6)

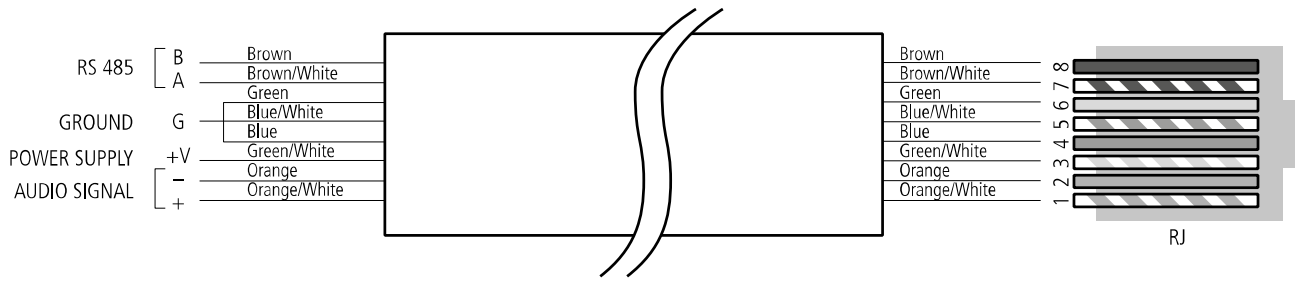

Correspondence of wires between CAT 6 and CJ 428CAT cables:

PIN	DESCRIPTION	CAT 6 WIRE COLOUR	CJ 428CAT WIRE COLOUR
1	Audio signal (+, hot)	Orange/White	Red
2	Audio signal (-, cold)	Orange	Blue
3	Power supply	Green/White	Yellow
4	Ground	Blue	Brown
5	Ground	Blue/White	Green
6	Ground	Green	Grey
7	RS 485 A (+)	Brown/White	White
8	RS 485 B (-)	Brown	Black



NOTE: in case of excessive background noise (on BM 3804 audio signal), link the cable shield to the earth by fixing it to the hole on the motherboard next to the BM 3804 input, between two washers (a flat and a grower).

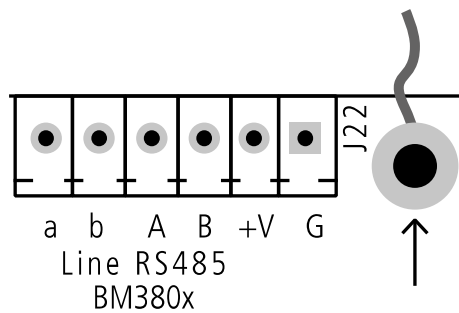

[2] AUX input, mainly for **BM 3022** paging microphones (not monitored).

PIN	DESCRIPTION	BM 3022 CABLE – WIRE COLOUR
+	Audio signal (+, hot)	Orange/White (RJ pin 1)
-	Audio signal (–, cold)	Orange (RJ pin 2)
G	Ground (audio)	Blue (RJ pin 4)
Pg	Priority and activation command	Green (RJ pin 6)
G	Priority and activation command ground	Green/White (RJ pin 3)

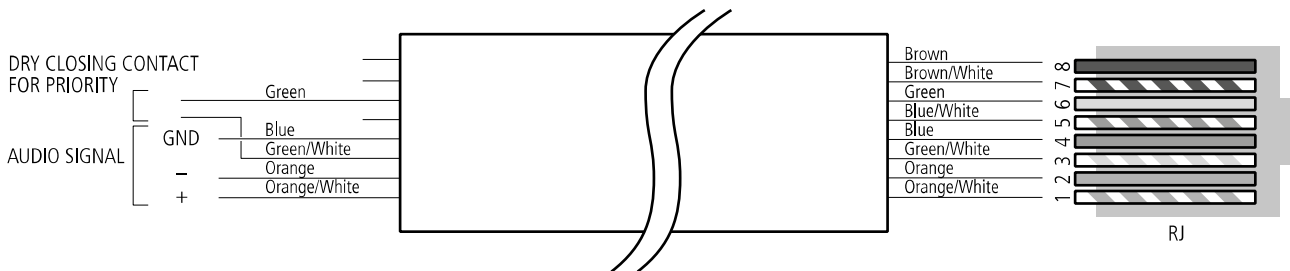

[3] **BGM IN** balanced audio input normally linked to the internal MP3 player, but also assignable to an external background music source (e.g. CD / MP3 player, tuner, etc.).

PIN	DESCRIPTION
+	Audio signal (+, hot)
-	Audio signal (–, cold)
G	Ground (audio)
Mt	MUTE command
G	MUTE command ground

[4] **ANY EVAC OUT** logic output (relay normally open dry contact), activated (relay contact shorted) when evacuation is in progress. (*)

[5] **GENERAL FAULT** logic output: relay normally closed dry contact (when MXR 4500 is turned on) that opens when either a fault is detected or MXR 4500 is off.

[6] **GPIN MSG RESET.** Opto-isolated logic input (enabled when 5 ÷ 48 V dc voltage is applied to its two contacts): when activated, it stops the evacuation / alert message playback.

[7] **GPIN MSG MUTE.** Opto-isolated logic input (enabled when 5 ÷ 48 V dc voltage is applied to its two contacts): when activated, it mutes the audio signal of the evacuation / alert message in progress, but its playback is not stopped.

[8] Logic input for the **external power supply fault**. The two contacts (PSU and G) need to be kept open when the external power supply is normal.

Shorting the two contacts entails the fault indication.

[9] Logic input to toggle the **day / night** operating mode:

-- 'DAY', the two contacts (N/D and G) are open

-- 'NIGHT', the two contacts (N/D and G) are shorted.

The 'NIGHT' mode attenuates the background music volume (BGM IN [3] level).

[10] **FORCE EVAC/ALERT IN**. Six opto-isolated logic inputs (one for each of the six possible zones) to force the evacuation / alert message playback with the mode defined by setting the GPIN MODE dip-switch [17]. The activation of the message playback in one or more zones is carried out by applying 5 ÷ 48 V dc voltage to their respective + and – contacts. See page 33 'Fire Alarm System Monitoring'.



All opto-isolated logic inputs allow the line monitoring (by the linked device) through two internal resistors: 1 kΩ in series and 6.8 kΩ in parallel.

[11] **EVAC/ALERT/PAGING OUT**. Six logic outputs (one for each of the six possible zones). Each is activated (the two contacts are shorted) during an announcement from a paging console or the playback of the evacuation / alert message, with the mode defined by setting the GPO MODE dip-switches [17]. (*)



(*) All logic output relays have the followings specs.:

- Max. current: 2 A
- Max. switching voltage: 100 V
- Max. switching power: 30 W

JUMPERS SETTINGS

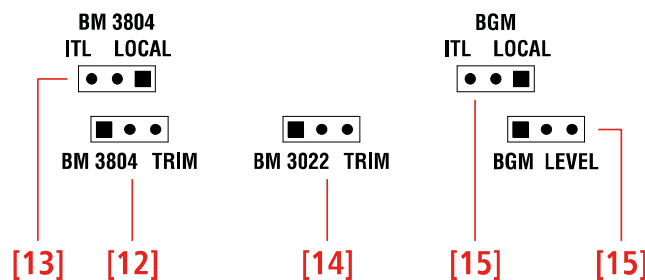

- [12] **BM 3804 TRIM** jumper: BM 3804 [1] audio input gain setting, useful to compensate for possible signal attenuation along the line.

JUMPER SETTING	INPUT GAIN
not inserted	no gain
pins 1 – 2	+ 3 dB
pins 2 – 3	+ 6 dB

- [13] **BM 3804** jumper to select the BM 3804 paging microphone input between the two options, either LOCAL (default setting) or INTERLINK (only when the optional INTERLINK board is present).

JUMPER SETTING	FUNCTION
LOCAL	(default setting): the BM 3804 [1] input is used for the connection of the BM 3804 paging microphone line.
ITL	INTERLINK (only with the optional INTERLINK board): the BM 3804 paging microphone line is connected to the INTERLINK board and the direct BM 3804 [1] input is disabled.

- [14] **BM 3022 TRIM** jumper: BM 3022 [2] audio input gain setting, useful to compensate for possible signal attenuation along the line.

JUMPER SETTING	INPUT GAIN
not inserted	no gain
pins 1 – 2	+ 3 dB
pins 2 – 3	+ 6 dB

- [15] **BGM** jumper to define the use of the local background music source (connected to the BGM IN [3] input) that can be set to either LOCAL or INTERLINK (only when the optional INTERLINK board is present).

JUMPER SETTING	FUNCTION
LOCAL	(default setting): the audio signal of the music source linked to the BGM IN [3] input is only available for the MXR 4500 main unit to which it is connected.
ITL	INTERLINK (only with the optional INTERLINK board): the audio signal of the music source linked to the BGM IN [3] input is shared by all devices connected through the INTERLINK board.

[16] **BGM LEVEL** jumper: BGM IN [3] audio input gain setting.

JUMPER SETTING	INPUT GAIN
not inserted	no gain
pins 1 – 2	+ 3 dB
pins 2 – 3	+ 6 dB

DIP-SWITCH

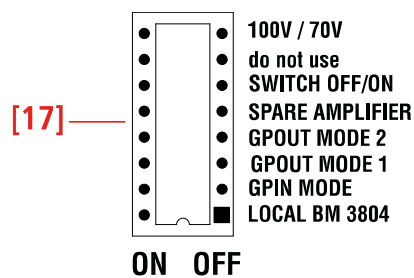

DIP-SWITCH	SETTING	FUNCTION
LOCAL BM 3804	OFF	BM 3804 paging microphones linked to the INTERLINK board (when available).
	ON	BM 3804 paging microphones are connected to the BM 3804 [1] input and directly control the zone selection.
GPIN MODE	OFF	SINGLE – EVACUATION mode: the activation of each logic input [10] entails the playback of the evacuation message in its zone (A = zone 1, B = zone 2, C = zone 3, D = zone 4, E = zone 5, F = zone 6).
	ON	DUAL – EVACUATION / ALERT mode: the activation of the first three logic inputs A, B, C [10] entails the playback of the evacuation message in zone pairs (A = zones 1-2, B = zones 3-4, C = zones 5-6); the activation of the second three logic inputs D, E, F [10] entails the playback of the alert message in zone pairs (D = zones 1-2, E = zones 3-4, F = zones 5-6). Note: the evacuation message has the priority.
GPOUT MODE 1 GPOUT MODE 2	1: OFF, 2: OFF	SINGLE – EVACUATION / ALERT mode: each logic output [11] (when activated) indicates the playback of the evacuation / alert message in its zone (A = zone 1, B = zone 2, C = zone 3, D = zone 4, E = zone 5, F = zone 6).

	1: ON , 2: OFF	SINGLE – EVACUATION / PAGING mode: each logic output [11] (when activated) indicates the playback of the evacuation message or paging in its zone (A = zone 1, B = zone 2, C = zone 3, D = zone 4, E = zone 5, F = zone 6).
	1: OFF, 2: ON	DUAL – EVACUATION / ALERT / PAGING mode: the first three logic outputs A, B, C [11] (when activated) indicate the playback of the evacuation / alert message in zone pairs (A = zone 1-2, B = zone 3-4, C = zone 5-6); the second three logic outputs D, E, F [11] (when activated) indicate paging in zone pairs (D = zone 1-2, E = zone 3-4, F = zone 5-6).
	1: ON , 2: ON	Not used.
SPARE AMPLIFIER	OFF	No spare amplifier.
	ON	The last available amplifier is assigned as spare. NOTE: see dedicated paragraph to activate the spare amplifier.
SWITCH OFF/ON	OFF	Since the system is designed to be left switched on, this setting forces its shutdown to allow the connection of batteries (in order to avoid possible sparks).
	ON	The system is turned on and operating.
DIP-SWITCH nr.7	Not used.	
100V / 70V	OFF	Speaker line voltage: 100 V.
	ON	Speaker line voltage: 70 V.

MESSAGES SD CARD BOARD

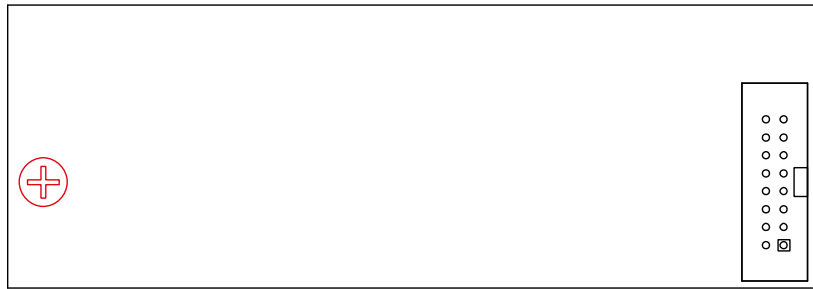

Remove the screw marked in RED to access the SD CARD and manage the messages.

The message player board is directly fitted to the main board. Messages are stored to an SD CARD, which can also be used to update the firmware.

The SD CARD is blocked from the spacer for the mounting to the main board, so that its removal is not possible, except by authorized personnel to access and maintain the system.

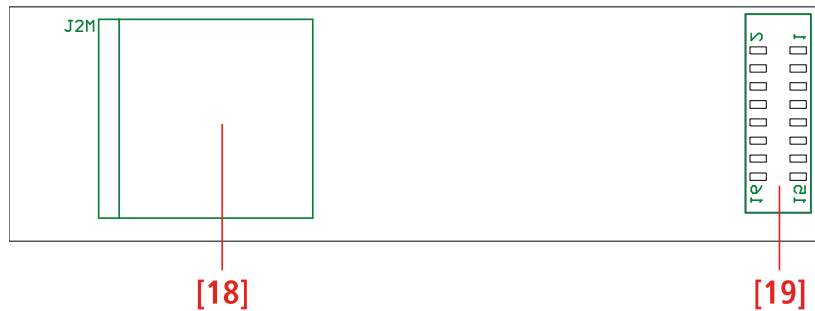

[18] SD CARD slot.

[19] Connector for the link to the main board.

Audio format	Ogg Vorbis, min. bitrate: 64 kbit/s
Max. message number	16, plus the chime
Sampling frequency	16 kHz or higher (suggested 44.1 kHz), mono
Resolution	16-bit

The max. message time is only limited by the SD CARD free memory.

Messages shall be converted before being stored to the SD CARD, by using a (free) software as, for instance, <http://www.ogg-converter.com>.

Messages shall be named as follows:

Nome	Dimensione	Tipo
File OGG		
a0.ogg	59 KB	File OGG
a1.ogg	70 KB	File OGG
a2.ogg	120 KB	File OGG
c0.ogg	59 KB	File OGG
c1.ogg	59 KB	File OGG
c2.ogg	171 KB	File OGG
e0.ogg	89 KB	File OGG
h0.ogg	10 KB	File OGG
e1.ogg	100 KB	File OGG
e2.ogg	189 KB	File OGG
e3.ogg	89 KB	File OGG
t0.ogg	74 KB	File OGG
t1.ogg	89 KB	File OGG
t2.ogg	58 KB	File OGG
t3.ogg	74 KB	File OGG
t4.ogg	100 KB	File OGG
t5.ogg	62 KB	File OGG

EMERGENCY MESSAGES

a0, a1, a2:

'Alert' messages (max. 3)

c0, c1, c2:

'All clear' messages (max. 3)

e0, e1, e2, e3:

'Evacuation' messages (max. 4)

h0, h1, h2:

chime sent before an announcement

SYSTEM TEST

t0 pre-test (main menu)

t1 test (main menu)

t2 end-test (main menu)

t3 pre-test (service menu)

t4 test (service menu)

t5 end-test (service menu)

INTERLINK BOARD

IE 3008 is an additional board that extends system's capability and functionalities allowing the connection of several units (up to 8).

IE 3008 board is installed next to the main board, on its left side and powered by the 24V DC available from the power supply.

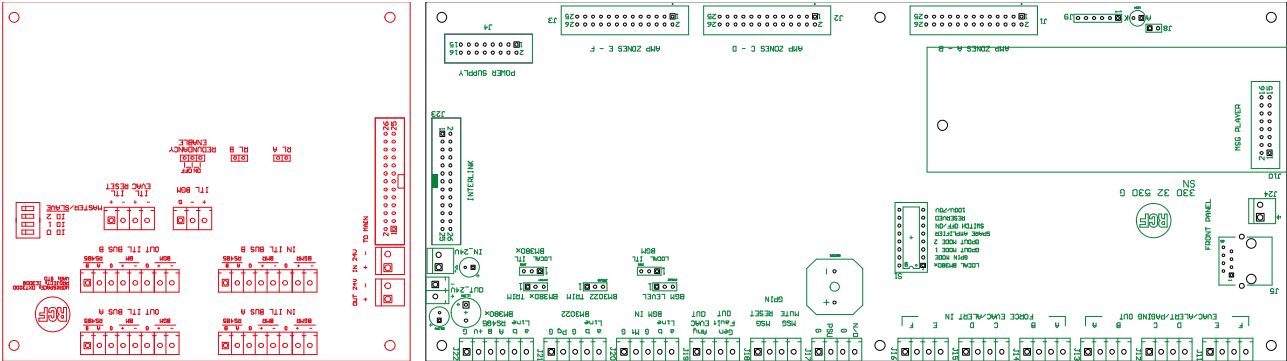

MAIN BOARD SETUP

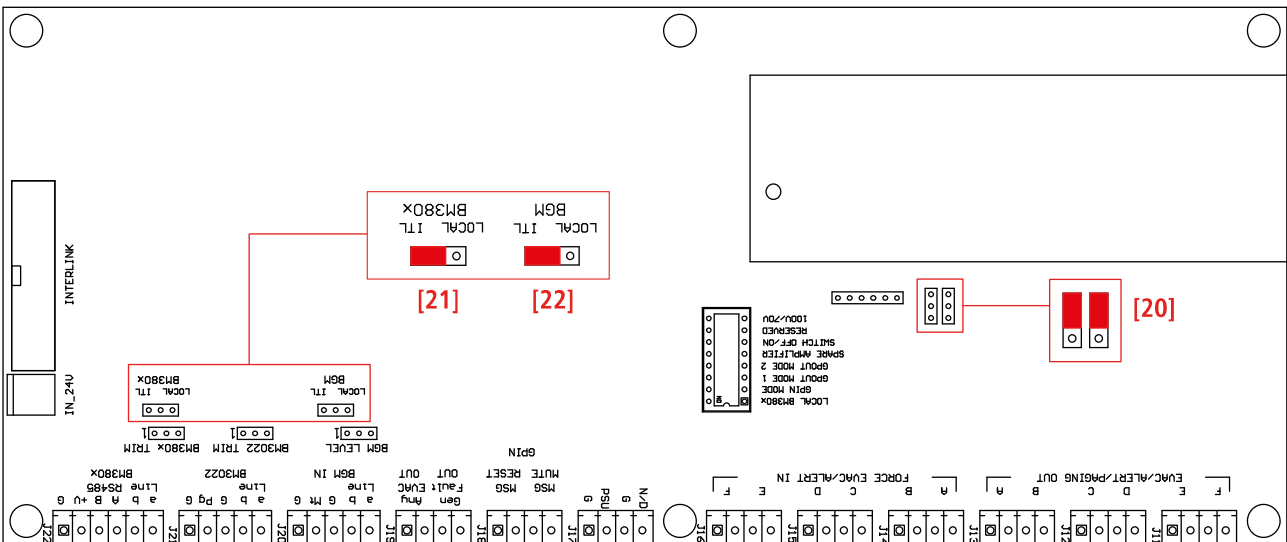

1. Check the jumpers [20] are corrected inserted in the position shown in the picture.
2. Move the BM 380x jumper [21] to from LOCAL to ITL.
3. If a GLOBAL BGM is required in the system (same BGM from the MASTER to all SLAVES) move BGM jumper [22] to from LOCAL to ITL.

MAXIMUM NUMBER OF UNITS

IE 3008 allows connecting up to 8 units MXR 4500 in a MASTER/SLAVE configuration. The first unit will be the MASTER, and the others will be SLAVES. A fixed ID will identify each unit, and can be set through a hardware DIP SWITCH placed on IE 3008.

MAXIMUM NUMBER OF CONSOLES BM 3804

IE 3008 allows connecting a maximum of 4 BM 3804, interlocked on a single chain. Only the first one can be used as EMERGENCY console and it is powered by the master unit. BM 3804 shall be connected to MAIN BOARD of the master unit.

MAXIMUM NUMBER OF CONSOLE EXTENSIONS BE 3806

Up to 8 BE 3806 can be connected to each BM 3804 in the chain. Each extension manages one MXR unit, and buttons are statically assigned to one zone only.

SYSTEM'S SPECIFICATIONS

The maximum distance allowed between MXR MASTER and last MXR SLAVE is 800m.

The maximum distance allowed between MXR MASTER and the last BM 3804 is 800m.

The maximum distance allowed between MXR MASTER and the first BM 3804 with 8 BE 3806 connected (all powered by the MXR unit) is 80m.

CONNECTIONS

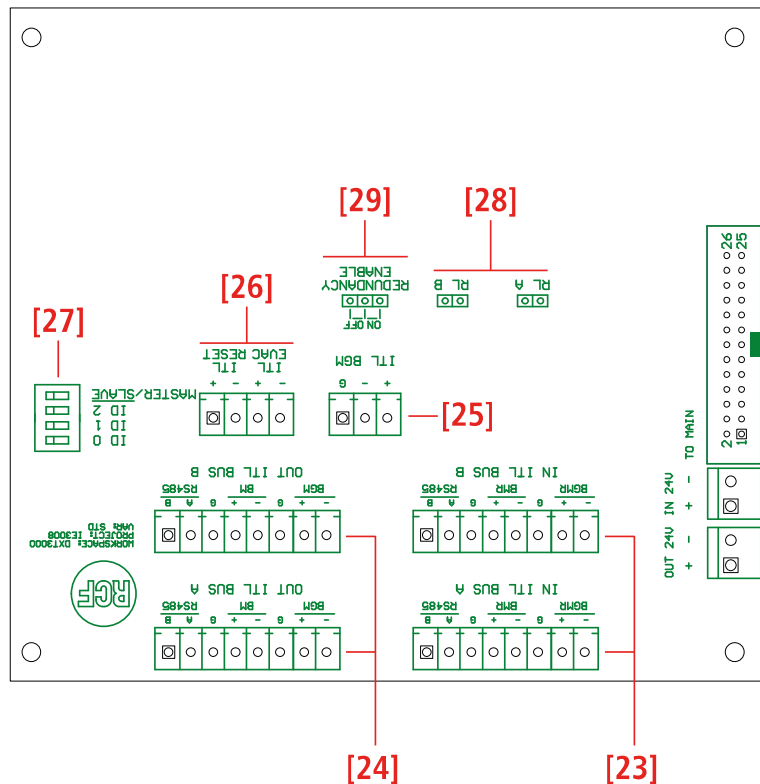

- [23] **BUS A** and **BUS B INPUT CONNECTORS** (8 poles): they receive 2 audio channels (BGM and emergency console BM 3804) and commands from the previous MX in the line. They are not used in the first MXR (MASTER).
- [24] **BUS A** and **BUS B OUTPUT CONNECTORS** (8 poles): they send audio and commands to the next MXR. They are not used in the last MXR unit.
- [25] **GLOBAL BGM INPUT CONNECTOR** (3 poles): it is the input connector for BGM audio signal, and shall be connected to first MXR only (MASTER), and the corresponding connectors on MXR main board will be disabled on all units. If local BGM only are required, use the dedicated connector on the main board of each unit.
- [26] **GLOBAL EVAC** and **RESET GPI**: photo-coupled contacts to activate (and reset) an EVAC event on the whole system. It can be triggered from external Fire Alarm System (FAS).

[27] ID SET DIP-SWITCH: it allows to set the ID number of each unit, and to set the MASTER.

	ID 0	ID 1	ID 2	MASTER / SLAVE
MASTER	LAST SLAVE ID			1
SLAVE 1	1	0	0	0
SLAVE 2	0	1	0	0
SLAVE 3	1	1	0	0
SLAVE 4	0	0	1	0
SLAVE 5	1	0	1	0
SLAVE 6	0	1	1	0
SLAVE 7	1	1	1	0

[28] BUS A and BUS B TERMINATOR RESISTORS: insert the jumper on both pin to terminate the lines and allow a correct monitoring. They shall be used ONLY on the last SLAVE unit.

[29] REDUNDANCY ENABLE: using the jumper is possible to deactivate the BUS redundancy (set the jumper on OFF). In this way, the system will not recognize and signal the absence of one BUS. Use this function ONLY during installation and for test purpose. ALWAYS set it to ON during normal system's functioning.

FUNCTIONS

When several DXT 4000 units are connected using IE 3008 the following functionalities are available:

EVAC/ALERT/PAGING

BM 3804 allows to trigger EVAC/ALERT/PAGING events, at general level or on each system zone. It means both the activation of pre-recorded or live messages.

The activation of EVAC/ALERT/PAGING events from Fire Alarm System (FAS) will act at local level on each unit. The same FAS can be connected to several units.

LOCAL PAGING

Local paging for non-emergency purpose is possible connecting to each unit a BM 3022 console.

BGM

BGM works both at system or local level, depending on the specific setting on the MXR MASTER:

- at system level, BGM will be injected on the dedicated input of IE 3008 on the MXR MASTER. Global MUTE command is available on the main board of the MXR MASTER;
- at local level, for each system, local sources can be connected to BGM input on each main board. Local MUTE commands are available on slaves MXR main board.

SPARE AMPLIFIER SETTING



WARNING: before proceeding with the setting, make sure that the unit is switched off and disconnected from the primary power source and from the batteries.

To set the spare amplifier functionality remove the metal flap on the lower left side of the unit's front panel.

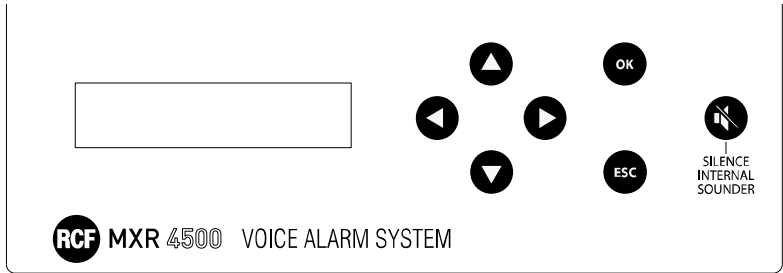
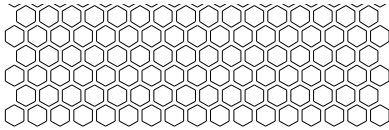

Behind the flap set the jumpers as shown in the pictures below.

SPARE AMPLIFIER DISABLED (default)	SPARE AMPLIFIER ENABLED

BATTERIES CONNECTION

System batteries shall be placed on a stable shelf inside the rack (e.g. RCF BH 1042).

Each unit requires 4 batteries (12 V – 18 Ah), to be connected together using the dedicated cables, included in the package.

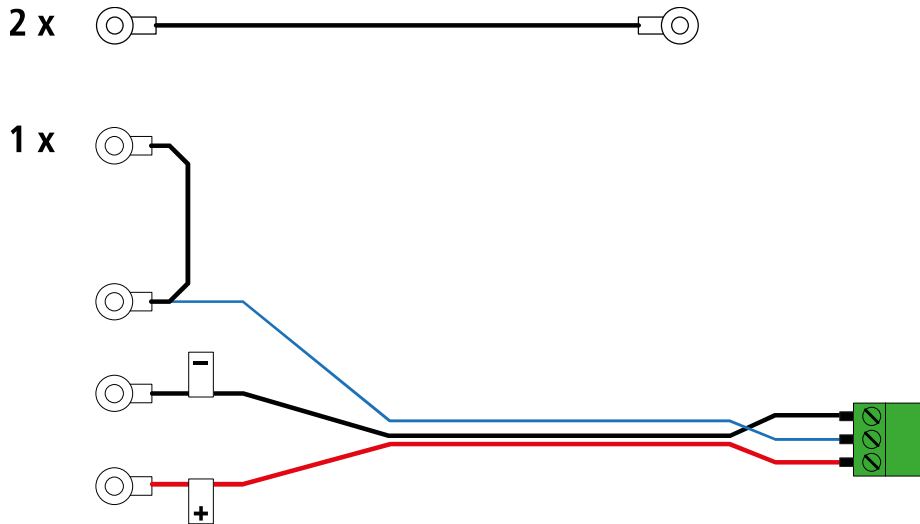

Connect battery cables following the sequence **A-B-C-D-E** shown in the picture.

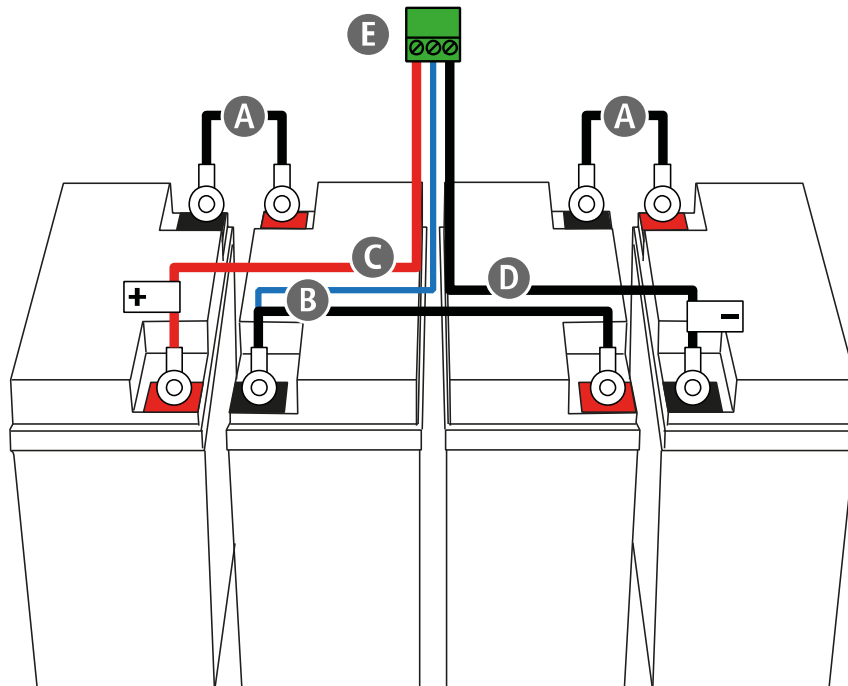

WARNING: to connect the batteries to the unit, strictly follow the start up procedure described in the following.

Connector **E** shall be linked to the 2 meters long extension cord provided in the package, and then to the connector placed on the unit's rear panel.

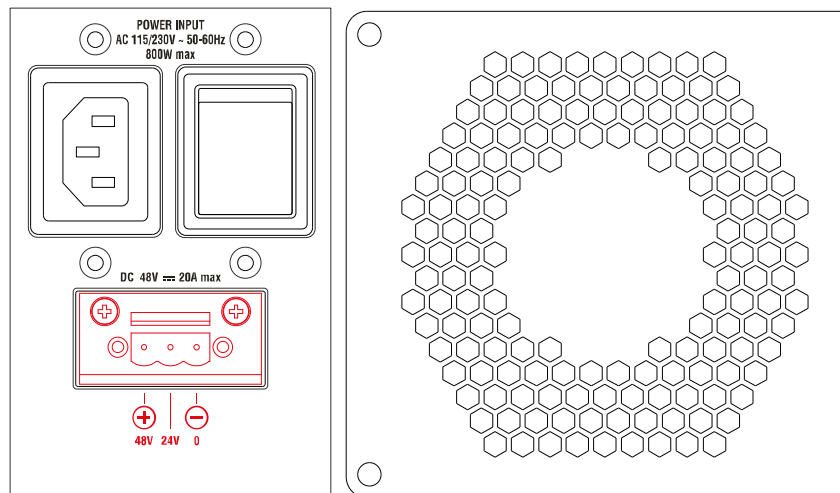

LOUDSPEAKERS CONNECTION

Loudspeakers lines connectors (euroblock) are placed in the upper right side of the unit's rear panel.

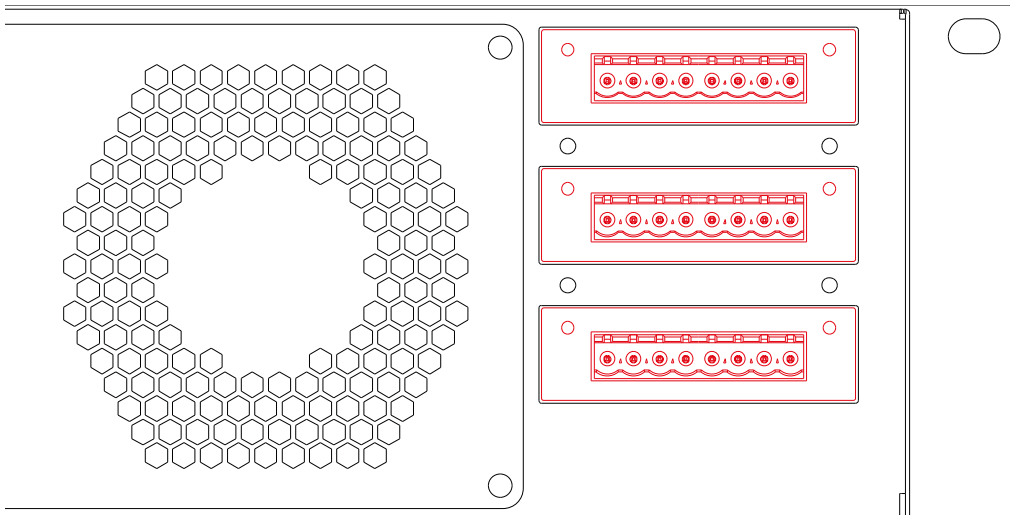

For loudspeakers connection refer to instructions shown on the cover label.

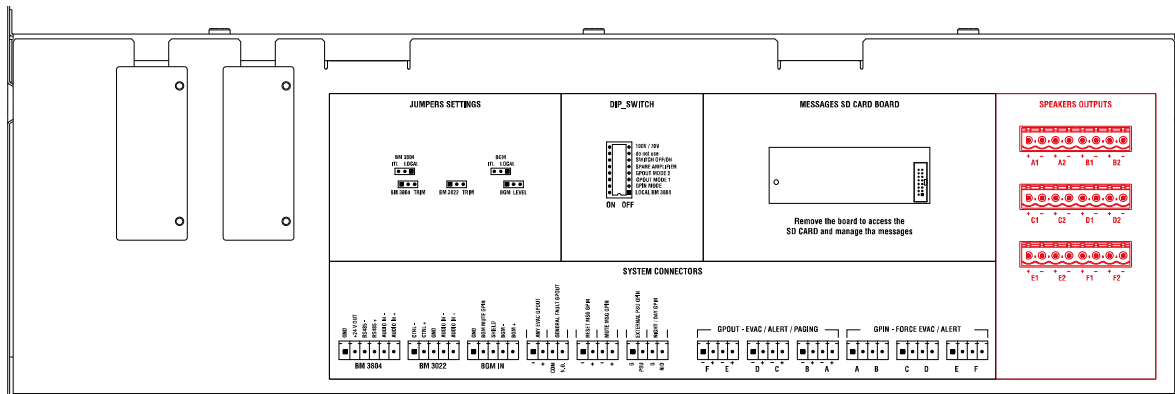

NOTES ABOUT CONSTANT VOLTAGE SYSTEMS

- The loudspeaker input voltage (V_d) shall correspond to the amplifier output voltage (V_a).
- The sum of nominal power values ($P_d \times n$) of all loudspeakers connected to the line shall not exceed the amplifier power (P_a).
- Make sure all loudspeakers are connected in phase to ensure a correct sound reproduction.

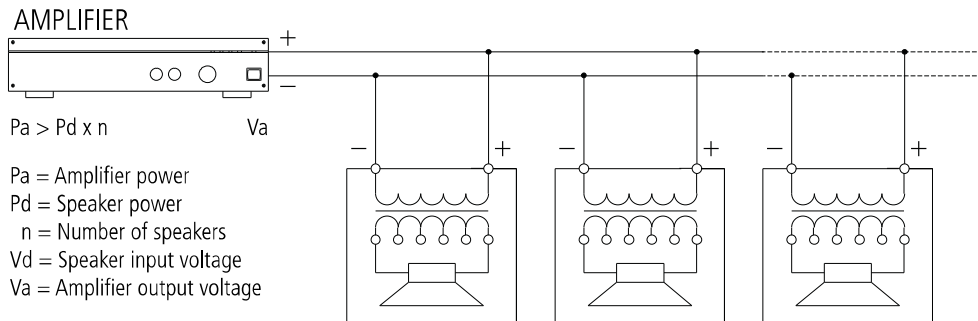

- Always use cables having wires with an adequate cross-section, considering the cable length and the total loudspeaker power.
- Loudspeaker lines must be kept separated from mains cable, microphone cables or others, in order to avoid inductive phenomena may cause hum or noises.
- Use loudspeaker cables having twisted wires to reduce hum caused by inductive effects due to coupling with electromagnetic fields.



In sound systems for emergency purposes, it is necessary to use fire-resistant cables.

GUIDANCE ON THE MEASUREMENT OF THE SPEAKER LINE IMPEDANCE

In the MXR 4000 units, monitoring of the integrity of speaker lines is made through impedance measurement at subsonic frequency (20 Hz).

This method was chosen because of its good stability and accuracy of calculated values, which avoids false line fault reports that often occur with impedance measurements faster at ultrasonic frequencies, but more prone to interferences and errors.

To use the MXR 4000 line monitoring properly, so that it fully complies with the European Safety Standard EN 54-16, it is strictly necessary to consider the functional limitations of all devices.

The two main limitations are:

- Measurable impedance range.
- The minimum / maximum tolerance compared to the calibration value of the measurement for the line fault detection.

Let us now analyse in detail these two limitations.

MEASURABLE IMPEDANCE RANGE

The impedance range is calibrated on the max. amplifier output power.

The amplifier board has two outputs (two zones) and the max. overall total power is 500 W (max. 250 W per each zone). The zone number can be increased to 4 or 6 (by adding one or two amplifier boards), but the max. total output power is always 500 W.

In a 100 V (or 70 V) constant voltage line, the minimum measurable impedance **Zmin** can be estimated (in all the three cases) considering a load having double the maximum output power **Pmax** (250 W) on a single line (and ignoring the efficiency of speakers and approximating the impedance at 20 Hz with the real one; the phasor impedance at 20 Hz is only 9 degrees out of phase with the real axis).

$$Z_{min_{100V}} = \frac{(100 \text{ V})^2}{2 P_{max}} \quad \text{or} \quad Z_{min_{70V}} = \frac{(70.7 \text{ V})^2}{2 P_{max}}$$

The result is:

$$Z_{min} = 20 \Omega \text{ (at 100 V)}, Z_{min} = 10 \Omega \text{ (at 70 V)}$$

The maximum measurable impedance **Zmax** can be estimated considering lines loaded to a quarter of the maximum output power **Pmax** on a single line.

$$Z_{max_{100V}} = \frac{(100 \text{ V})^2}{0.25 P_{max}} \quad \text{or} \quad Z_{max_{70V}} = \frac{(70.7 \text{ V})^2}{0.25 P_{max}}$$

The result is:

$$Z_{max} = 160 \Omega \text{ (at 100 V)}, Z_{max} = 80 \Omega \text{ (at 70 V)}$$

Amplifiers are protected and designed to operate at their maximum rated power. **The best impedance range (Zmon), in which its measurement is more stable, immune to errors and repeatable, is from 50% to 100% of the load corresponding to the maximum power of the channel.**

$$\text{With 100 V lines: } 40 \Omega \leq Z_{mon} \leq 80 \Omega$$

$$\text{With 70 V lines: } 20 \Omega \leq Z_{mon} \leq 40 \Omega$$

Note that (depending on tolerances of sensors) measures higher or lower than the indicated limits can be similarly accurate and valid. These values shall be considered as 'confidence thresholds' of the line control. In fact, sensors could measure impedances (at 20 Hz) in the 5 ÷ 400 Ω range. Measuring of impedances out of that range may be prone to errors and interferences.

TOLERANCE COMPARED TO THE CALIBRATION VALUE

The choice of the speaker line impedance tolerance is important in order to avoid these two cases:

- Too low tolerance: every little interference will cause a false line fault.
- Too high tolerance: the system will not report any fault even with a line damage that excludes most speakers.

EN54-16 standard requires the system to indicate speaker line faults (short or open circuits) and not a single speaker fault. Therefore, a single speaker fault is tolerable, but not the loss of a line section.

In a 100 / 70 V line all speakers are linked in parallel, so a short circuit (total impedance tends to zero) leads to the opening of the entire speaker line.

The choice of the tolerance (six options: 20-30-40-50-60 %) is important to get a proper speaker line monitoring.

Consider the following general rule:

“The recommended tolerance value is the highest of the available options, but lower than the weight of the smallest percentage change in impedance, usually due to the disconnection of the speaker having the highest impedance and installed at the end of a line branch.”

An example: a line has a total impedance 80 Ω (**Ztot**) and ends with a 400 Ω-speaker (**Zmaxend**).

In case of **disconnection of the 400 Ω-speaker**, the line total impedance will change from **80 Ω (Ztot)** to **100 Ω (Znoend)**.

The following formula is basically the calculation of the impedances in parallel:

$$\mathbf{Znoend} = \frac{\mathbf{Zmaxend} \times \mathbf{Ztot}}{\mathbf{Zmaxend} - \mathbf{Ztot}}$$



NOTE: the line impedance here is considered at the frequency of 20 Hz (which is not equal to the one measured by an impedance meter at 1 kHz)!

The percentage difference between the two impedances is 25%, so it is necessary to set the tolerance to the 20% option.

However, there are many cases where the weight percentage of the last speaker is less than 20%, often making impossible to detect any damage to the line.

Moreover, there are speakers (e.g. horns) that are virtually open circuits at the frequency of 20 Hz, making it impossible to measure the line impedance.

In these cases, it is strictly necessary to connect (at the end of lines) devices having an impedance (at 20 Hz) that allows the calibration (in the proper range of each channel) and low enough to make it possible to detect the opening of the last line segment.

These devices are just named ‘End Of Line’, hereafter abbreviated as EOL.

EOL (‘END OF LINE’): FEATURES AND USE GUIDELINES

EOL are reactive loads having an impedance 200 Ω at the resonance frequency (20 Hz).

Absorbing reactive power only, EOL can be added to a speaker line without affecting the rated power of its amplifier. However, this is valid if considering the dynamic of the impedance meter, which can properly measure up to a maximum load of twice the rated amplifier power.

To ensure proper line monitoring when the constrain of the last speaker of various line branches (explained in the previous paragraph) is not respected, it will be necessary to add an EOL at the end of each line branch.

The maximum number of EOL that can be added is **six**.

This is due to problems of dynamics of the impedance measuring circuit and the amplifier (eddy currents need to be considered, as these can overload the amplifier). The EOL will be assigned to the available lines in order to allow impedance measurement.

The total impedance (**Ztot**) resulting from the parallel between the load impedance already present in the line (**Zline**) and EOL (**Zeol** = 200 Ω) is easily obtainable by the following formula:

$$\mathbf{Ztot} = \frac{\mathbf{Zline} \times \mathbf{Zeol}}{\mathbf{Zline} - \mathbf{Zeol}}$$



NOTE : the line impedance (Z_{line}) here is considered at the frequency of 20 Hz (which is not equal to the one measured by an impedance meter at 1 kHz)!

In case of a single line having a particularly low impedance load or lines including horn speakers (open circuits at 20 Hz), it will be necessary to add more EOL in parallel.

In case the line is divided into more branches, in each branch the EOL number needs to be the same, in order to guarantee a proper monitoring and respect the following formula:

$$Neol > \frac{200 \Omega}{Z_{tot} (21 - N_{branch})}$$

Neol = EOL number
Ztot = total impedance
Nbranch = line branch number

Within the system operation limits, the result is equal to 1.

Anyway, to know how many EOL are needed in a line, it is necessary to calculate the total impedance (**Ztot**) by applying the following formula (parallel impedances), adjusted with the EOL number (**Neol**):

$$Z_{tot} = \frac{Z_{line} \times \frac{200 \Omega}{Neol}}{Z_{line} + \frac{200 \Omega}{Neol}}$$



NOTE : the line impedance (Z_{line}) here is considered at the frequency of 20 Hz (which is not equal to the one measured by an impedance meter at 1 kHz)!

The total impedance must respect the constraints about EOL.

Max. EOL number is six.

FIRE ALARM SYSTEM MONITORING

SINGLE LINE MONITORING - GENERAL ALARM

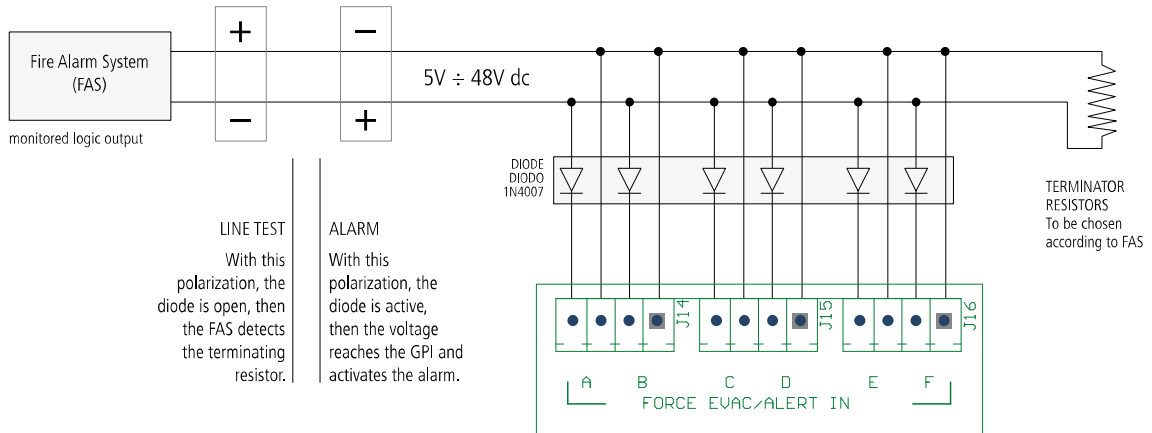

SEPARATE MONITORING OF EACH LOGIC INPUT - ZONE ALARM

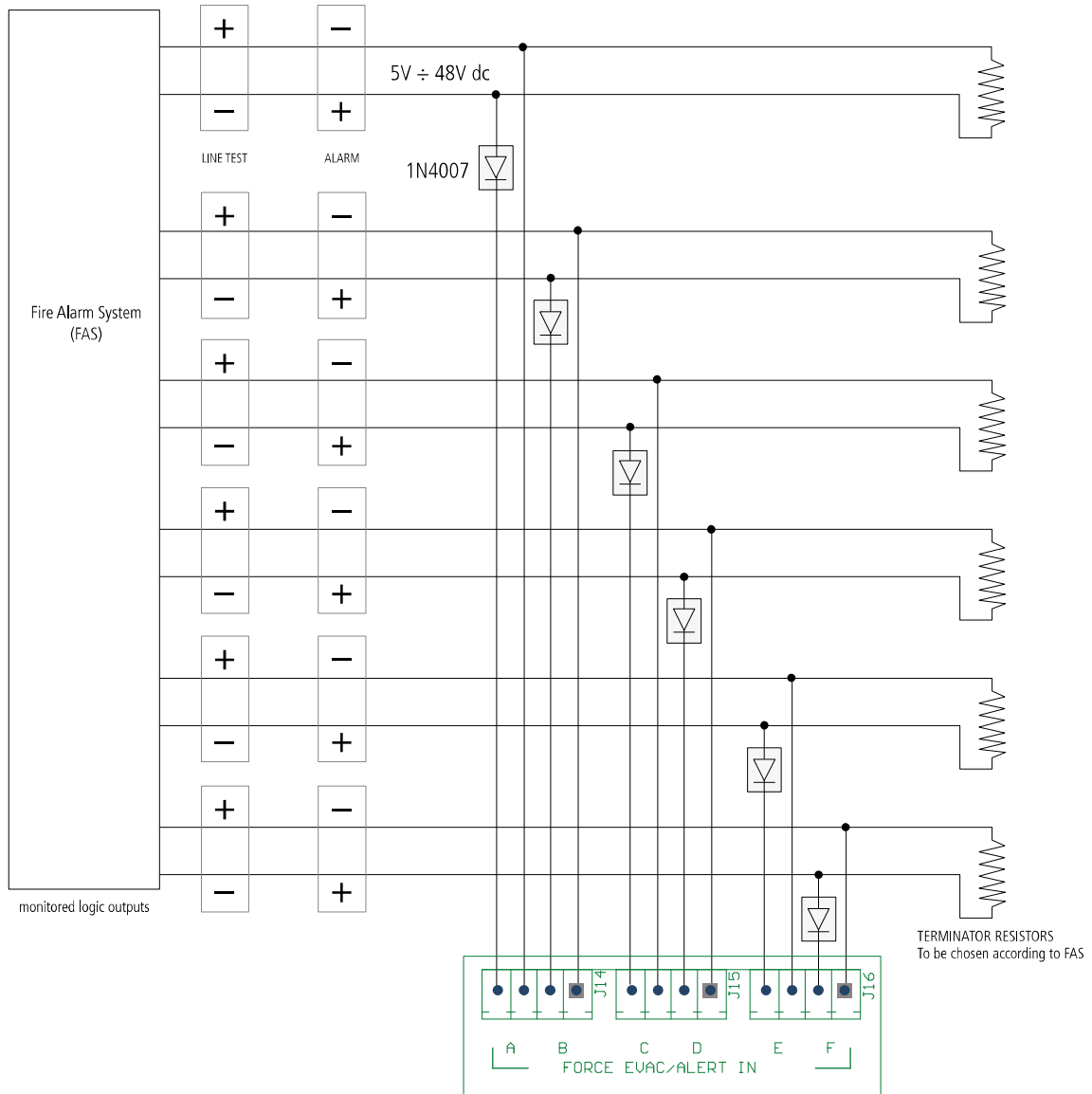

START UP PROCEDURE



To turn the system on correctly, avoiding any risk for installers, it is necessary proceed as follows:

1. **Ensure the main unit is not powered from mains and batteries are disconnected.**
2. **Make sure the main board dip-switch no. 6 (SWITCH ON/OFF) [17] is set to OFF.**
3. **Connect the batteries.**
4. **Connect the MXR 4500 main unit to the mains power supply.**
5. **Set the main board dip-switch no. 6 (SWITCH ON/OFF) [17] to ON.**

To turn the system off, follow these steps in reverse order.

FRONT PANEL BOARD

The front panel board includes all indicator lights (LEDs) for all signs required and all system commands, included SERVICE functionalities, reserved to authorized and specialized personnel only.

To access SERVICE MENU remove the metal flap on the lower right side of the unit's front panel.

Then press and hold the SERVICE button until the SERVICE MENU is displayed.

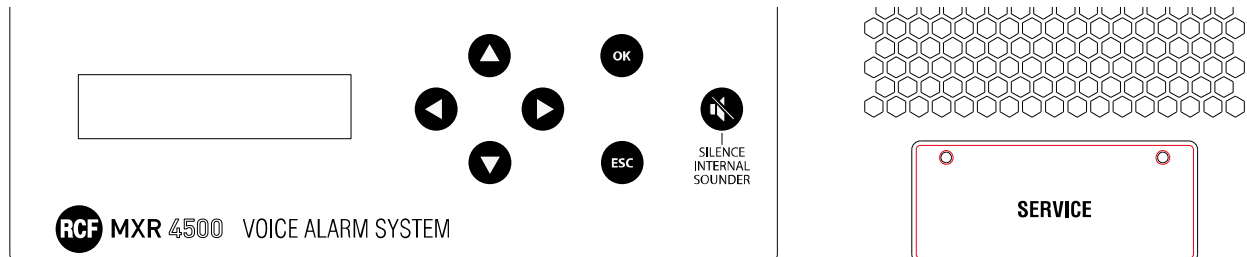

The access to the other menus is regulated by password levels.

PASSWORD CHANGE

MXR 4500 has 4 access levels, which correspond to operating rights, as required by EN 54-16:2008.

The first level (0) does not require any password.

About the other levels, their initial default passwords are:

- Level 1 111
- Level 2 222
- Level 3 333

To change a password, it is necessary to proceed as follows:

1. Turn the system off.
2. Remove the SD CARD (with prerecorded messages).
3. Add the file 'PASS.TXT' onto the SD card, file previously edited by a PC (Windows o.s.) with the following lines:
XXX Level 1 new password with 3 digits (0 – 9).
YYY Level 2 new password with 3 digits (0 – 9).
ZZZ Level 3 new password with 3 digits (0 – 9).
4. Insert the SD card into the message player board.
5. Turn the system on and await the password updating.
6. Turn the system off again.
7. Remove the SD CARD (with prerecorded messages).
8. Delete the file 'PASS.TXT' on the SD CARD.
9. Insert the SD card into the message player board.
10. Turn the system on.

FRONT PANEL

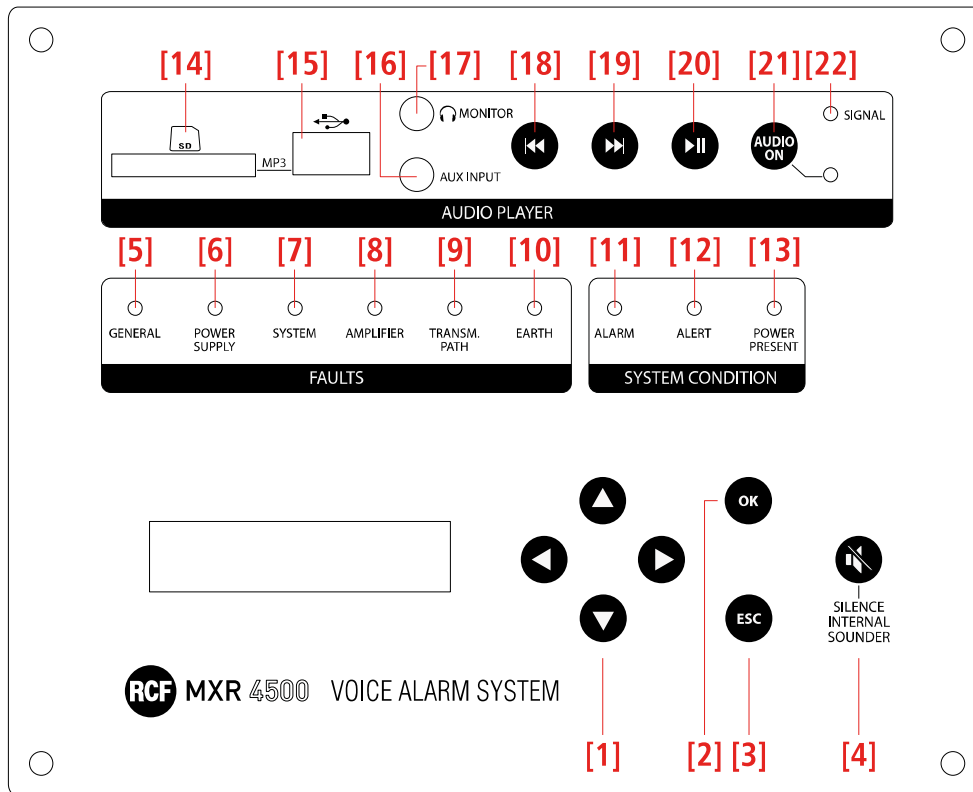

- [1] Four key-cursor (▲: up, ▼: down, ◀: left, ▶: right)
- [2] **OK** button: press to select.
- [3] **ESC** button: press to quit the displayed menu.
- [4] **SILENCE INTERNAL SOUNDER** button: press to mute the internal sounder (fault acknowledge).

FAULT LEDs

- | | | |
|-------------------------|--------|---|
| [5] GENERAL | Yellow | One or more faults have been detected. |
| [6] POWER SUPPLY | Yellow | Power supply fault. |
| [7] SYSTEM | Yellow | Internal microprocessor reset. |
| [8] AMPLIFIER | Yellow | One or more amplifiers are faulty (see the display). |
| [9] TRANSM. PATH | Yellow | Faults are detected in the signal path, e.g. in paging microphones and/or speaker lines and/or the INTERLINK board. |
| [10] EARTH | Yellow | Speaker line earth leakage. |

SYSTEM CONDITION LEDs:

- | | | |
|---------------------------|--------|---|
| [11] ALARM | Red | The evacuation message is currently played. |
| [12] ALERT | Yellow | The alert message is currently played. |
| [13] POWER PRESENT | Green | Either the mains (230 – 115 V ac) or the 24 V dc power supply is present. |

MP3 AUDIO PLAYER

[14] SD card port (“Secure Digital”).

Do NOT use it if a USB flash drive is inserted into its respective port **[15]**.

[15] USB flash drive port.

Do NOT use it if a SD card is inserted into its respective port **[14]**.

The file extension must be .mp3 (MPEG Audio Layer 3: refers to a compressed audio coding format).

All folders of the SD card / USB drive are automatically scanned.

MP3 file playback is in alphabetical order.

[16] AUX INPUT. Auxiliary unbalanced audio input (for 1/8” stereo / TRS jack) to connect an external audio source. This input is stereo, but its signal is internally summed to mono and sent to the system only when:

- The front panel MP3 player is paused.
- The AUDIO ON **[21]** button has been pressed and its LED is lit (audio enabled).

[17] MONITOR. Audio output (for 1/8” stereo / TRS jack) mainly for headphones, but it can also be used as LINE OUT. This audio output is always open (even if the AUDIO ON button is off), then allows pre-listening music (before sending it to the system).

[18] Press this button to select the previous MP3 file.

[19] Press this button to select the next MP3 file.

[20] Press this button to toggle PLAY / PAUSE (MP3 player playback). Volume levels can be adjusted in the system settings.

[21] AUDIO ON. Button with blue LED. When pressed, it toggles on (LED lit) / off the sending of the internal MP3 audio player signal (and also AUX IN **[16]**) to the system.

[22] SIGNAL LED. Blue LED indicating the audio signal presence, with light intensity variation as a function of the signal level.

PARAMETER LIST

LEVEL 1	LEVEL 2	LEVEL 3	DESCRIPTION
INFO			
	FIRMWARE VER		Microprocessor current firmware release.
	AMP VER		Current firmware release of the microprocessor for line monitoring.
	DSP VER		DSP current firmware release.
	ZONES NUMBER		System zone number.
		ACTIVE EVC/ALRT	Zones with evacuation or alert in progress.
		GPI MASK	[DEBUG] Logic input (GPI) bit mask (from the amplifier board).
		RELAYS MASK	[DEBUG] Relay bit mask (from the amplifier board).
		FAULT MASK	[DEBUG] Fault bit mask (from the amplifier board).
		ACK MASK	[DEBUG] Fault acknowledge bit mask.
		CONSOLES NUM	Number of paging microphones connected to the system.
		CONSOLES MASK	[DEBUG] Connected paging microphone bit mask.

LEVEL 1	LEVEL 2	LEVEL 3	DESCRIPTION
AUDIO SET			
BGM			BGM IN (music) audio settings.
INPUT LEVEL			Input level (- 40 ÷ + 6 dBu).
EQUALIZER			2-band equalizer (HI/LO) (-10 ÷ + 12 dB).
ASSIGN (for each zone)			It assigns the BGM IN to the selected zones.
EVENT LEVEL (for each zone)			Zone output level (- 40 ÷ + 6 dBu).

LEVEL 1	LEVEL 2	LEVEL 3	DESCRIPTION
AUDIO SET			
		MESSAGES	Audio setting of pre-recorded messages.
		INPUT LEVEL	Input level (- 40 ÷ + 6 dBu).
		EQUALIZER	2-band equalizer (HI/LO) (-10 ÷ + 12 dB).
		ASSIGN (for each zone)	It assigns the message playback to the selected zones.
		EVENT LEVEL (for each zone)	Zone output level (- 40 ÷ + 6 dBu).
		BM 3804	BM 3804 input audio settings.
		INPUT LEVEL	Input level (- 40 ÷ + 6 dBu).
		EQUALIZER	2-band equalizer (HI/LO) (-10 ÷ + 12 dB).
		ASSIGN (for each zone)	It enables BM 3804 paging microphones in the selected zones.
		EVENT LEVEL (for each zone)	Zone output level (- 40 ÷ + 6 dBu).
AUX INPUT			BM 3022 input audio settings.
INPUT LEVEL			Input level (- 40 ÷ + 6 dBu).
EQUALIZER			2-band equalizer (HI/LO) (-10 ÷ + 12 dB).
ASSIGN (for each zone)			It enables BM 3022 paging microphones in the selected zones.
EVENT LEVEL (for each zone)			Zone output level (- 40 ÷ + 6 dBu).
VOX ENABLE			Set to ON to enable the VOX automatic priority when a signal is detected at the AUX INPUT (OFF: disabled).
VOX LEVEL			VOX function level setting from 0 (highest sensitivity) to 15 (lower sensitivity), default value: 8.

LEVEL 1	LEVEL 2	LEVEL 3	DESCRIPTION
AUDIO SET			
		ZONE n (for each zone; n: selected zone)	Selected zone audio settings.
		LEVEL	Output level (NOTE: to be used only for temporary changes, as it is overwritten by the parameter EVENT LEVEL).
		EQUALIZER	2-band equalizer (HI/LO) (-10 ÷ + 12 dB).
		HI-PASS	Hi-pass filter (20 / 500 Hz).

LEVEL 1	LEVEL 2	LEVEL 3	DESCRIPTION
FAULTS			
	[EVC/ALRT ZONE LIST]		Evacuation / alert zone list.
	[FAULT LIST] FAULT_GENERAL FAULT_MAINS FAULT_BATTERY FAULT_AMP FAULT_SDCARD FAULT_VS1000 FAULT_BM380X FAULT_BM3022 FAULT_FP FAULT_DSPA FAULT_DSPB FAULT_FLASH FAULT_EEPROM EXT. FAULT FAULT_LINE1 FAULT_LINE2 FAULT_LINE3 FAULT_LINE4 FAULT_LINE5 FAULT_LINE6 FAULT_AUDIO_PATH FAULT_OVER_POWER FAULT_LINE1_IMP FAULT_LINE2_IMP FAULT_LINE3_IMP FAULT_LINE4_IMP FAULT_LINE5_IMP		general fault mains (ac) fault battery (dc) fault amplifier board SD card message board fault BM 3804 paging microphone BM 3022 paging microphone front panel board fault DSP A DSP B FLASH memory EEPROM external fault line 1 line 2 line 3 line 4 line 5 line 6 monitored audio path excessive power line 1 impedance line 2 impedance line 3 impedance line 4 impedance line 5 impedance

LEVEL 1	LEVEL 2	LEVEL 3	DESCRIPTION
FAULTS			
	FAULT_LINE6_IMP FAULT_LINE_EARTHED FAULT_SPARE_ON		line 6 impedance line with earth leakage spare amplifier

LEVEL 1	LEVEL 2	LEVEL 3	DESCRIPTION
UTILITY			
	LEDS BUZZER TEST		LED and buzzer test.
		ESC TIMEOUT	Automatic quit from menus after a certain time [ON/OFF].
		LCD BACKLIGHT	Display backlight adjustment.
		DISCOVERY CONS.	Search for connected paging microphones.
		LINE TEST	It enables / disables line monitoring [ON/OFF].

LEVEL 1	LEVEL 2	LEVEL 3	DESCRIPTION
MESSAGES			
	EMERGENCY		
	PLAY EVACUATION		It starts the playback of the 'evacuation' message chosen in the SERVICE menu (the 'evacuation' event is in progress).
	PLAY ALERT		It starts the playback of the 'alert' message chosen in the SERVICE menu (the 'alert' event is in progress).
	PLAY CLEAR		It starts the playback of the 'all clear' message chosen in the SERVICE menu (note: if an emergency event is in progress, RESET is the only way to cancel it and PLAY CLEAR is disabled).
	MESSAGE SILENCE		It mutes the message currently played, but it does not cancel the event in progress.
	MESSAGE RESET		It stops the message playback and cancels the current event.

LEVEL 1	LEVEL 2	LEVEL 3	DESCRIPTION
MESSAGES			
	USER MESSAGES		Main menu user messages
	PLAY PRE-TEST		It plays the pre-test message.
	PLAY TEST		It plays the test message.
	PLAY END-TEST		It plays the end-test message.
	STOP		It stops the current message.
LOGIN (access to the security levels by entering the 3-digit password)			
LOGOUT (quit and return to the lowest security level '0')			

LEVEL 1	LEVEL 2	LEVEL 3	DESCRIPTION
SERVICE			
		LINE CALIBR.	Calibration of each line.
		IMPEDANCE VALUES	It displays the current impedance value of each line.
		IMP THRESHOLD	Choice of the max. tolerance variation of impedance as fault threshold among 20-30-40-50-60 %.
		DIAGNOSTIC	Internal diagnostic (device communication check) [OK/ FAULT].
		BATTERY STATUS	FAULT / GOOD.
		SYSTEM REBOOT	
		CONFIGURATION	
		LOAD	It loads a configuration from the FLASH memory.
		SAVE	It stores the configuration to the FLASH memory.
		SELECT MSG	Message selection and service test
		EVACUATION	Preferred 'evacuation' message selection (chosen among 4).
		ALERT	Preferred 'alert' message selection (chosen among 3).
		CLEAR	Preferred 'all clear' message selection (chosen among 3).
		PRE-TEST	It plays the pre-test message.
		TEST	It plays the test message.
		END-TEST	It plays the end-test message.

LEVEL 1	LEVEL 2	LEVEL 3	DESCRIPTION
SERVICE			
		CHIME MESSAGE	Preferred chime selection among no.1, 2, 3.
		EVAC GPI N. S.	GPI normal status selection: OPEN (default) or CLOSED.
		EVAC GPO N. S.	GPO normal status selection: OPEN (default) or CLOSED.
		RESET GPI N. S.	MSG RESET GPI normal status selection: OPEN (default) or CLOSED.
		SIL. GPI N. S.	MSG MUTE GPI normal status selection: OPEN (default) or CLOSED.
		EXIT	It quits the menu.

DIMENSIONS

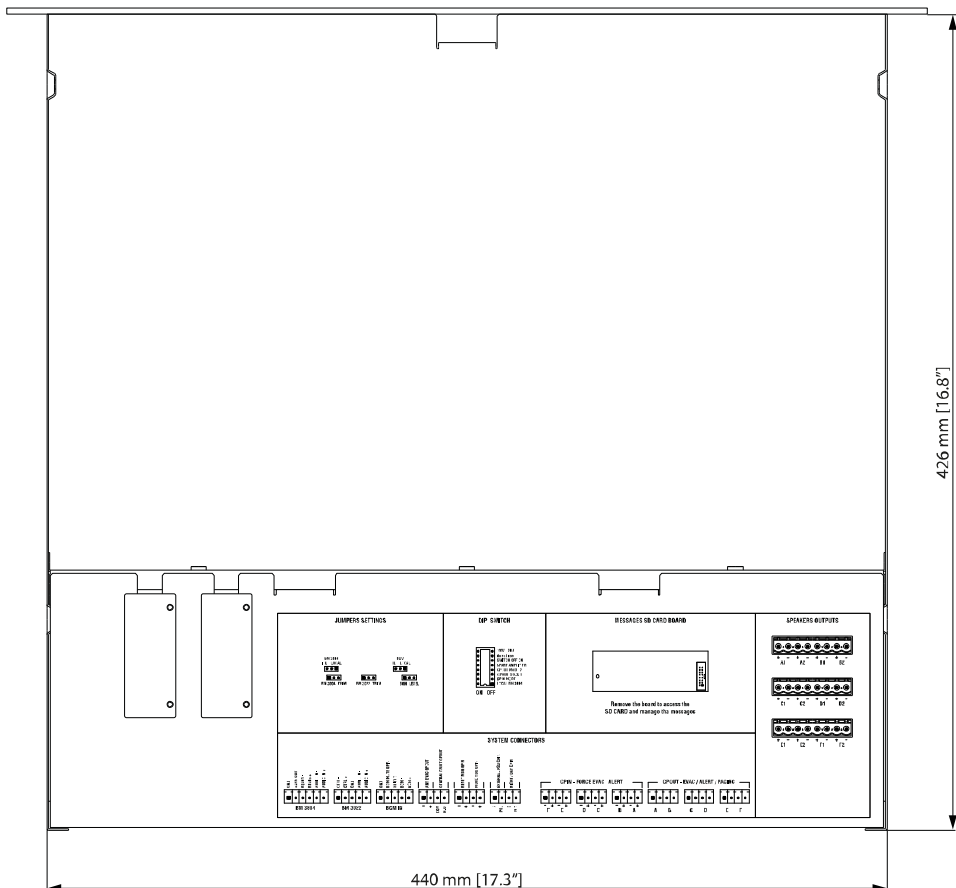
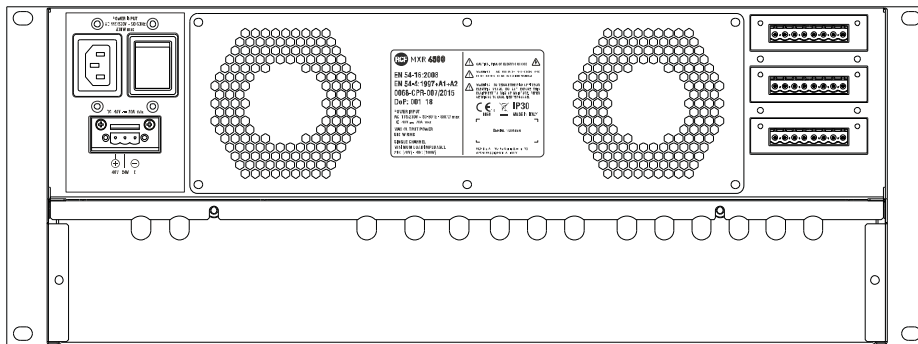
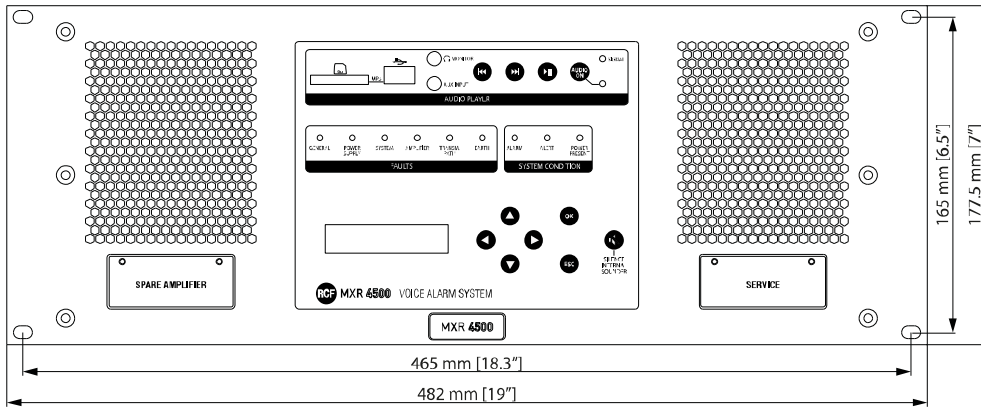

SPECIFICATIONS

System specifications

Number of zones managed	6 (MXR 4500/6) / 4 (MXR 4500/4) / 2 (MXR 4500/2)
Built-in power amplifier	Yes
Spare amplifier automatic change-over	Yes
Max number of consoles	4
Number of console buses	1
Number of simultaneous emergency audio channels	1
Max number of units connectable	8
Communication bus	Serial
Connection Cables	J-Type fire-rated
Integrated pre-recorded emergency messages	Yes

Amplifier specifications

Amplifier Class	D+
Number of channels	6 (MXR 4500/6) / 4 (MXR 4500/4) / 2 (MXR 4500/2)
Power output (@ 100 V)	500 W RMS
A/B speakers line	Yes
Frequency Response (-3dB)	80 Hz ÷ 16 kHz
Signal/noise rate ("A" weighted)	>98 dB
Distortion (THD+N) @ 1 kHz nominal power	<0.3 %

Input section

Total number of inputs	3
Balanced	3
Mono	3
Line inputs	2
Line connectors	Euroblock, JACK
VOX	Yes
Paging inputs	1
Paging connectors	Euroblock
Paging command	Serial
Paging emergency	Yes
General Purpose Inputs (GPI)	6
Monitored GPI	6
Photo-coupled GPI	6

Output section

Signal output number	1
Signal output connectors	JACK
Power output lines	6
Power output connectors	Euroblock
General Purpose Outputs (GPO)	6

Processing

DSP	Yes
Tone controls	Yes
High-pass filter	20 Hz ÷ 500 Hz

Controls	
Configuration	DIP switch, Front panel
Chime tone	Yes

Protections	
Cooling	Convection
Short circuit	Yes
Thermal	Yes
DC	Yes
Fuses	Yes
VHF (Very High Frequencies)	Yes

Audio sources	
USB pen drives	Yes
SD card	Yes

Power requirement	
Operating voltage	220-240/115 V~ 50/60Hz
Voltage selection	Internal
DC power	Yes
DC power value	48 V
Power consumption	700 W

Standard compliance	
IP protection grade	IP 30
Safety agency	CE compliant
EN54-16 certified	Yes
EN54-4 certified	Yes
CPR number	0068-CPR-007/2015

Physical specifications	
Cabinet/Case Material	Metal
Color	Black
Rack mounting	19", 4U

Size	
Height	177.5 mm / 7 inches
Width	482 mm / 19 inches
Depth	426 mm / 16.8 inches
Weight	22 kg / 48.5 lbs

