



**INSTALLED** SOUND



# CONTENT

## SPEAKERS

A click on the product name leads directly to the relevant catalog page

<b>HL SERIES</b>	
HL 2290	pag. 6
HL 2260	pag. 6
HL 2240	pag. 6
HS 2200	pag. 6
HL 20-WP	pag. 10
HL 6	pag. 12
HL 35-S	pag. 14
H 1315 WP	pag. 16

<b>HVL SERIES</b>	
HVL 15-P	pag. 18
HVL 15-P1	pag. 20
HVL 15-L	pag. 22
HVL 15-L1	pag. 24
HVL 15-S	pag. 26

<b>Q SERIES</b>	
Q 15	pag. 28
Q 15-L	pag. 30
Q 15-P	pag. 32

<b>COMPACT C SERIES</b>	
COMPACT C 45	pag. 34
COMPACT C 32	pag. 36

<b>COMPACT SERIES</b>	
C 3110-126	pag. 38
C 3110-96	pag. 40
C 3108-126	pag. 42
C 3108-96	pag. 44

<b>COMPACT M SERIES</b>	
COMPACT M 12	pag. 46
COMPACT M 10	pag. 48
COMPACT M 08	pag. 50
COMPACT M 06	pag. 52
COMPACT M 05	pag. 54

<b>COMPACT M SERIES</b>	
COMPACT M 04	pag. 56

<b>COMPACT A SERIES</b>	
COMPACT A 15	pag. 58
COMPACT A 12	pag. 60
COMPACT A 10	pag. 62

<b>MAX SERIES</b>	
X-MAX 12	pag. 64
X-MAX 10	pag. 66
C-MAX 4112	pag. 68
C-MAX 4110	pag. 70
E-MAX 3112 MKII	pag. 72
E-MAX 3110 MKII	pag. 74

<b>P SERIES</b>	
P 5228-L	pag. 76
P 4228	pag. 78
P 3108	pag. 80
P 1108T	pag. 82
P 6215	pag. 84
P 3115T	pag. 86
P 2110T	pag. 88
P 8015S	pag. 90

<b>PASSIVE TWO-WAY SPEAKER</b>	
ART 725 MK4	pag. 92

<b>SUB SERIES</b>	
S 8028 II	pag. 94
S 8018 II	pag. 96
S 8015 II	pag. 98
S 8015LP	pag. 100
S 15	pag. 102
S 12	pag. 104
S 10	pag. 106

## ELECTRONICS

<b>XPS SERIES</b>	
XPS 16K	pag. 108
XPS 16KD	pag. 108

<b>QPS SERIES</b>	
QPS 10K	pag. 112
QPS 6K	pag. 112

<b>IPS SERIES</b>	
IPS 5.0K	pag. 114
IPS 2.5K	pag. 114
IPS 1.5K	pag. 114

<b>DMA SERIES</b>	
DMA 504	pag. 116
DMA ACCESSORIES	pag. 118

<b>DX PROCESSORS</b>	
DX 1616	pag. 122
DX 4008	pag. 122

<b>RDNET CONTROL</b>	
RDNET CONTROL 8	pag. 124
RDNET CONTROL 2	pag. 125

# RCF Sound Culture

RCF is a leading technology brand of professional audio equipment, transducers, electronics, DSP, and custom solutions for any sound and any place. Established in Italy in 1949, RCF has been committed to the perfect reproduction and amplification of sound for events and concerts, recording, public address, broadcast, and portable audio. RCF has consistently transformed the pro-audio industry, developing components and products in-house to ensure maximum quality and reliability to the end-user. The comprehensive catalog covers all aspects of the audio chain to satisfy sound engineers, architects, and system integrators.



## ADVANCED TECHNOLOGIES

Innovation comes first and foremost, thanks to the RCF R&D team, developers of many original products and technologies, such as the hyper-venting system, the inside/outside voice coil, the dual silicone spiders, and countless mechanical, digital, and leading-edge electronic solutions. RCF is one of the few loudspeaker companies worldwide that internally manufacture transducers, speaker systems, electronics, and software. All products feature RCF's exclusive designs and technologies such as CMD Coverage Matching Design horns,

providing consistent horizontal and vertical pattern control through the usable frequency range. RCF exclusive LICC Low Inductance Compensated Crossover ensures exceptional audio performance and stability. Zero degrees phase alignment FIRPHASE technology for clarity and perfect sound image; matching amplification and control systems to fully optimize the high performance and long-term reliability RCF is renowned for. Passive speaker systems also include RCF built-in dynamic electronic protections.

The Installed Sound range represents a prominent chapter in the company's long history, continuously expanding one of the most comprehensive product portfolios offering dedicated integrated audio solutions with superior acoustic performance. This catalog includes speaker systems designed to meet all pro-audio contractors requirements for fixed installations like café or theme bars, retail outlets, places of worship, theatres, restaurants, live venues, dance clubs, theme parks, airports, hotels, railway stations, shopping malls, auditoriums, congress centers, sporting facilities, stadia, etc.



## SUPPORT AND TRAINING

RCF is always at the forefront of technologies and materials research, providing tools, documentation, technical support to help professionals deliver optimized sound to the listener. Training activities for all audio professionals and enthusiasts draw into 70 years of experience and knowledge of its engineers. The internal support engineering team is on hand to assist architects, system designers, or integrators during the design and customization of complex systems. Tangible

technical expertise, modern Italian manufacturing facilities, and the continuous technological refinement set RCF as an essential reference for all audio professionals and enthusiasts. RCF supports customers in its offices in the United States of America, France, Germany, Italy, Spain, the United Kingdom, and a network of more than hundreds of trusted distributors throughout the rest of the world.

# HL SERIES

## HL SERIES

HORN LOADED ARRAY SYSTEM

### HS 2200

ARRAY SUBWOOFER

The HL 2260 (2240, 2290) is a horn loaded two-way full range array system that incorporates a 2 x 12" woofer and a 1.4" exit 4.0" voice coil titanium compression driver for mid distance and long throw applications. The system is very compact and provides very high output and accurate voice and sound reproduction. The system is equipped with the latest generation of RCF precision transducers. The system has a vertical dispersion of 22.5° and is ideally used in point source configuration for mid distance applications or can be clustered with narrower angles for long throw applications. The loudspeaker enclosure shape is trapezoidal and offers a 22.5° coupling angle each side. Connections to the amplifier are made through a watertight Amphenol multi-pole connector.

- Horn Loaded two-way Array System
- Fully Horn-loaded, 60° x 22.5° (40° x 22.5°, 90° x 22.5°) directivity
- 2 x 12" RCF Precision woofers with 3.5" voice coil
- RCF Precision 4.0" voice coil compression driver, titanium dome
- 141 dB Max SPL
- Horn loading on RCF waveguide
- System Power rating 1500 W RMS (1350 W LF, 150 W HF)
- Safe and solid variable array mechanics
- Baltic Birch Plywood enclosure with internal structural metal bracings

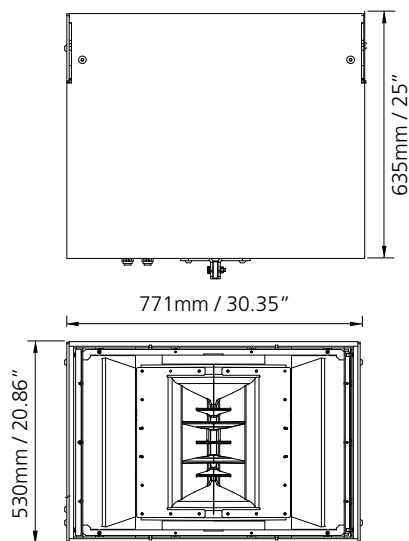
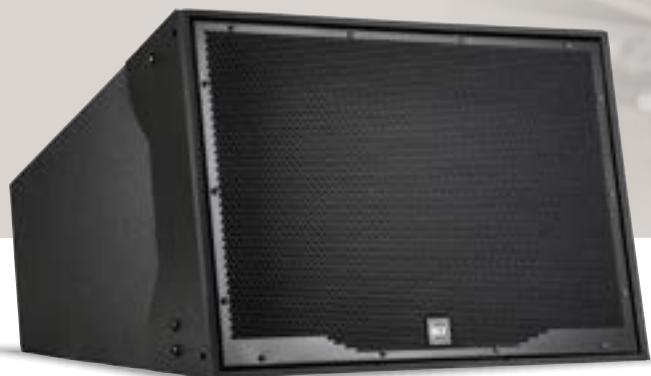

The cabinet is constructed of multi-ply Baltic birch marine plywood and finished in a very resistant, textured, polyurea black paint.

The cabinet is equipped with 12 x M 8 brass inserts, a stainless steel U-Bracket and pair of spacers for 90° mounting.



The grille is in custom perforated aluminium with open-cell fibres and water repellent woven fabric backing.



## SPECIFICATIONS

### HL 2290

p.n. 13000405

### HL 2260

p.n. 13000407

### HL 2240

p.n. 13000404

### HS 2200

p.n. 13000406

#### Acoustical specifications

Frequency Response (-10dB):	60 Hz ÷ 20000 Hz	60 Hz ÷ 20000 Hz	60 Hz ÷ 20000 Hz	30 Hz ÷ 200 Hz
Frequency Response (-3dB):	80 Hz ÷ 20000 Hz	80 Hz ÷ 20000 Hz	80 Hz ÷ 20000 Hz	35 Hz ÷ 200 Hz
Max SPL @ 1m:	141 dB	141 dB	141 dB	136 dB
Horizontal coverage angle:	90°	60°	40°	-
Vertical coverage angle:	23°	22.5°	22.5°	-
Directivity index Q:	16	14	13	-

#### Power section

Amplification:	Bi-Amp	Bi-Amp	Bi-Amp	Full Range
Crossover Frequencies:	600 Hz	600 Hz	600 Hz	-
Nominal Impedance LF:	8 ohm	8 ohm	8 ohm	8 ohm
Power Handling LF:	1350 W	1350 W	1350 W	900 W
Peak Power Handling LF:	5400 W	5400 W	5400 W	3600 W
Recommended Amplifier LF:	2700 W	2700 W	2700 W	-
Nominal Impedance HF:	8 ohm	8 ohm	8 ohm	-
Power Handling HF:	150 W	150 W	150 W	-
Peak Power Handling HF:	600 W	600 W	600 W	-
Recommended Amplifier HF:	300 W	300 W	300 W	1800 W

#### Transducers

Compression Driver:	1 x 1.4" neo, 4.0" v.c	1 x 2.0" neo, 4.0" v.c	1 x 2.0" neo, 4.0" v.c	-
Woofer:	2 x 12", 3.5" v.c	2 x 12", 3.5" v.c	2 x 12", 3.5" v.c	18", 4.0" v.c

#### Input/Output section

Input connectors:	Amphenol eco/mat IP 67
Output connectors:	Amphenol eco/mat IP 67

#### Standard compliance

IP protection grade:	IP 55	IP 55	IP 55	-
Safety agency:	CE compliant	CE compliant	CE compliant	CE compliant

#### Physical specifications

Cabinet/Case Material:	Baltic birch plywood			
Hardware:	Side and rear array rigging point			
Grille:	Steel			
Color:	Black			
Dimensions (H x W x D):	20.87"x 30.35"x 25.00"   530 x 771 x 635 mm			
Weight:	69 kg / 152.12 lbs	70.4 kg / 155.21 lbs	69 kg / 152.12 lbs	50.8 kg / 111.99 lbs

# 22 HL SERIES

## HL SERIES

HORN LOADED ARRAY SYSTEM

## HS 2200

ARRAY SUBWOOFER



The system is fully horn-loaded and it is ideally used either in point source configuration for mid distances or clustered with narrower angles for long-throw applications.



### LOW FREQUENCY

The HL 2260 (2240, 2290) is a 2 x 12" woofer and a 2.0" exit with 3.5" voice-coil.  
The HS 2200 is a 18" high-efficiency 4.0" voice coil woofer with Inside/Outside Coil Technology.



### HIGH FREQUENCY

The HL 2260 (2240, 2290) is a 4" compression driver with a 1.5" exit throat.

## ARRAY FITTINGS

The HL SYSTEM is equipped with standard array fittings and IP 55 weather protection.







## HL 2290

RESPONSE 1W/1m

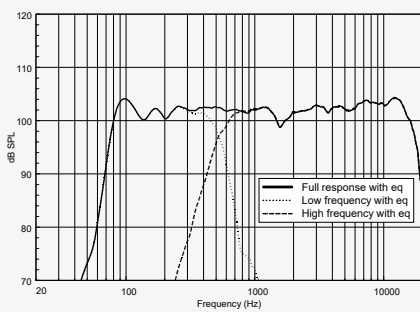

### BEAMWIDTH vs. FREQUENCY

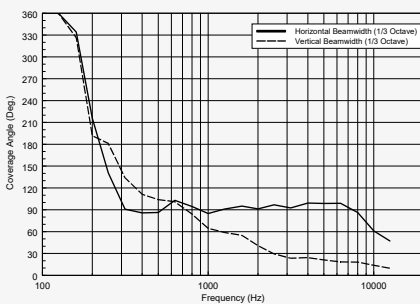

### DIRECTIVITY INDEX AND Q

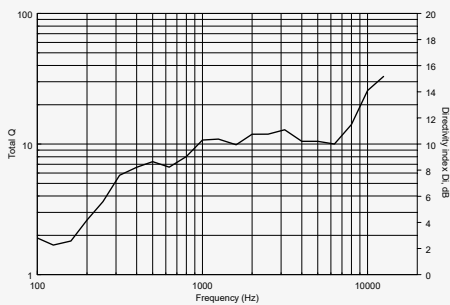

## HL 2260

RESPONSE 1W/1m

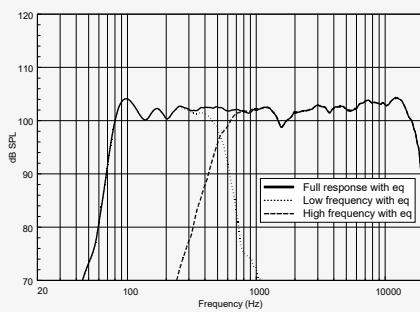

### BEAMWIDTH vs. FREQUENCY

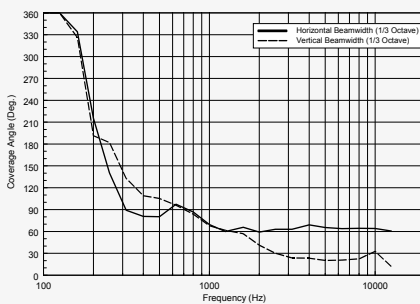

### DIRECTIVITY INDEX AND Q

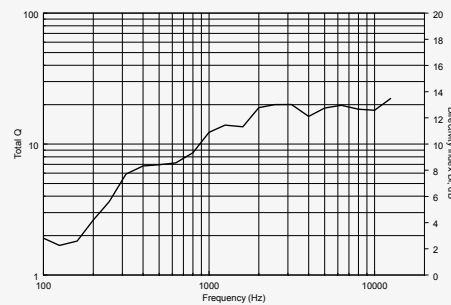

## HL 2240

RESPONSE 1W/1m

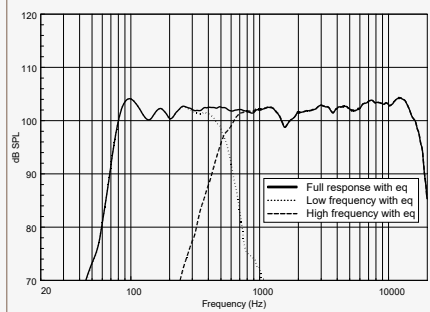

### BEAMWIDTH vs. FREQUENCY

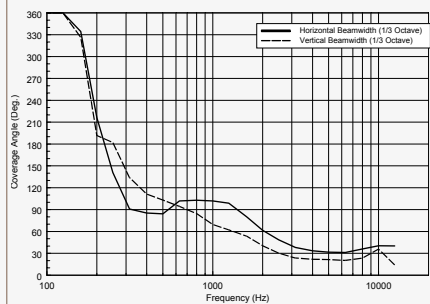

### DIRECTIVITY INDEX AND Q

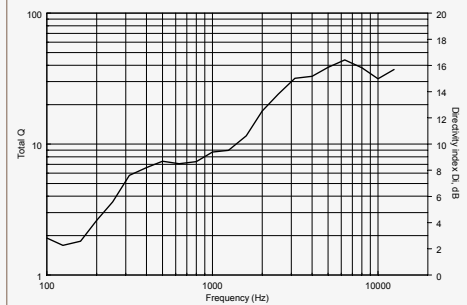

## HS 2200

RESPONSE 1W/1m

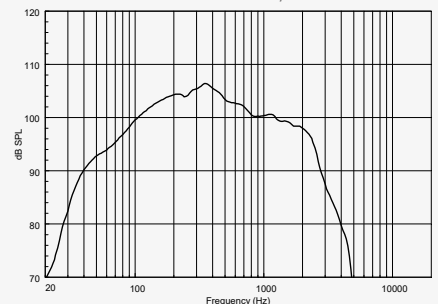

### RELATED ACCESSORIES



#### FL-B HL p.n. 13360282

Suspending bar for HL line array system

- To suspend HL 2240, HL 2260, HL 2290, HS 2200
- Strong steel construction

# 20 HL SERIES

## HL 20-WP

### WEATHERPROOF PASSIVE LINE ARRAY MODULE

HL 20-WP is a two-way, bi-amp passive line array module that offers a very wide dispersion and high performance for such a compact size. The incredible high output and dynamics, the extreme accuracy and high frequency extension plus the compact size makes the HL 20-WP the ideal tool for outdoor sound reinforcement, live performances and events as well as fixed installations in theatres, concert halls or auditoriums. Connections to the amplifier are made through a watertight multi-pole connector. The grille is in custom perforated aluminum with open-cell fibers and water repellent woven fabric backing. The cabinet is constructed of multiply baltic birch plywood and finished in a fire resistant, textured coating.

- Very compact size
- Maximum output per size available on the market
- Wide, constant directivity, horizontal coverage angle
- Minimum weight
- Watertight multi-pole connector IP67
- Baltic birch cabinet



#### LOW FREQUENCIES

Water resistant fibre doped cone  
Polycotton M-roll surround  
High power magnetic structure



#### HIGH FREQUENCIES

The ND840 large format compression driver delivers one of the key advantages of the HL 20-WP. The 3" voice coil allows a crossover point of 800 Hz, therefore almost all of the vocal range can be produced by this driver. This allows better coverage, dispersion control, and superior efficiency.

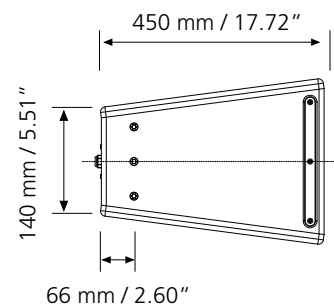
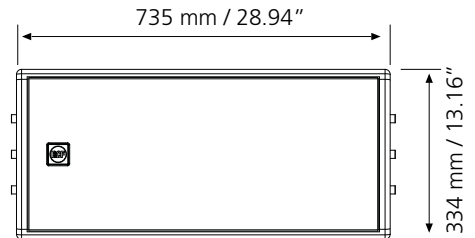



## SPECIFICATIONS

### HL 20-WP

p.n. 13000473 (White) - p.n. 13000643 (Black)

#### Acoustical specifications

Frequency Response (-10dB):	55 Hz ÷ 20000 Hz
Max SPL @ 1m:	135 dB
Horizontal coverage angle:	100°
Vertical coverage angle:	15°
Directivity index Q:	16

#### Power section

Amplification:	Bi-Amp
Crossover Frequencies:	Recommended 800 Hz
Nominal Impedance LF:	16 ohm
Power Handling LF:	600 W
Peak Power Handling LF:	2400 W
Recommended Amplifier LF:	1200 W
Sensitivity LF:	98 dB
Nominal Impedance HF:	16 ohm
Power Handling HF:	110 W
Peak Power Handling HF:	440 W
Recommended Amplifier HF:	220 W
Sensitivity HF:	109 dB

#### Transducers

Compression Driver:	1.5", 3.0" v.c
Woofer:	2 x 10", 2.5" v.c

#### Input/Output section

Input connectors:	Cable
-------------------	-------

#### Standard compliance

Safety agency:	CE compliant
----------------	--------------

#### Physical specifications

Cabinet/Case Material:	Baltic birch plywood
Hardware:	6 x M10 inserts
Grille:	Steel with waterproof clothing
Color:	White, Black
Dimensions (H x W x D):	13.14"x 28.93"x 17.71"   334 x 735 x 450 mm
Weight:	66.58 lb   30.2 kg

RESPONSE 1W/1m

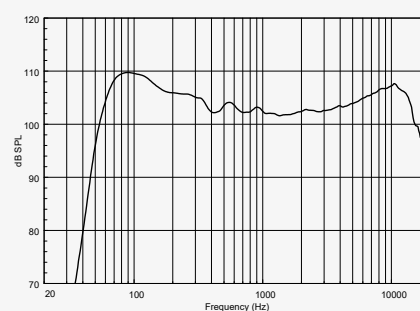

BEAMWIDTH vs. FREQUENCY

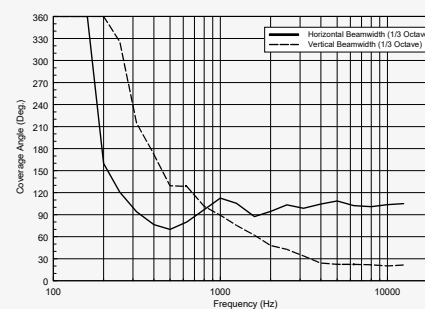

DIRECTIVITY INDEX AND Q

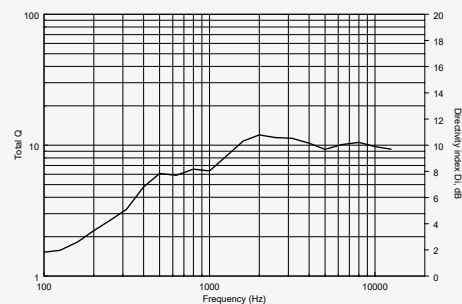

# 6 HL SERIES

## HL 6

### LINE ARRAY MODULE

HL 6 is two-way full range system, ideal when line array performance is needed, and a fast and easy set-up is a must. The concept of this speaker derives from the touring industry, bringing in a compact cabinet all the experience of RCF professional sound. HL 6 features state-of-the-art RCF transducers, two powerful 6.0" woofers for a solid bass reproduction, plus a high powered 1.75" voice coil compression driver mounted on a precise 100° x 10° waveguide to deliver vocal clarity with high definition and incredible dynamic. Due to its symmetrical design the HL 6 produces constant coverage without break up or attenuation, maintaining intelligibility, definition, and signal strength over distance. HL 6 comes in a structurally wooden reinforced composite polypropylene enclosure, and it is equipped with two rear handles for portability.

- 250 W RMS power handling
- 131 dB max SPL
- 43 ÷ 18000 Hz frequency range
- 100° x 10° coverage angles
- Fully equipped with neodymium transducers
- Horn Loaded symmetric design
- Wooden reinforced polypropylene enclosure
- Steel grille with clothing
- 2 x SPEAKON connectors

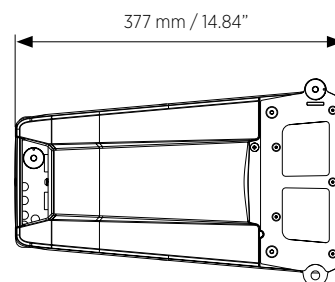
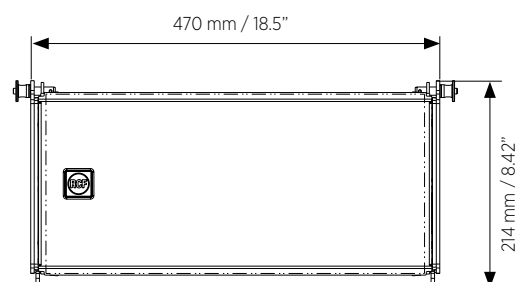

### RELATED ACCESSORIES



#### AZM-BR 2X

p.n. 13360351

Azimuth bracket. 2 pieces. To be added for horizontal array control.



#### FL-B HDL 6

p.n. 13360360

Flybar for HL 6; HL 35-S + 1x Pickup Tab with Shackle + Stacking Bar + Pole Mount + M20 Adapter. Pins included.



#### CL-BR HDL 6

p.n. 13360371

Clamp bracket



#### FL-B PK HDL 6

p.n. 13360372

Pickup Tab with Shackle for HL 6; HL 35-S. To be added to the flybar when rigging with 2 motors. Pins included.



## SPECIFICATIONS

### HL 6

p.n. 13000726

#### Acoustical specifications

Frequency Response (-10dB):	65 Hz ÷ 20000 Hz
Max SPL @ 1m:	131 dB
Horizontal coverage angle:	100°
Vertical coverage angle:	10°
Directivity index Q:	16

#### Power section

Amplification:	Full Range
Nominal Impedance:	16 ohm
Power Handling:	250 W
Peak Power Handling:	1000 W PEAK
Recommended Amplifier:	500 W
Protections:	Dynamic Active Mosfet
Crossover Frequencies:	900 Hz

#### Transducers

Compression Driver:	1 x 1.0" neo, 1.75" v.c
Woofer:	2 x 6.0" neo, 2.0" v.c

#### Input/Output section

Input/Output connectors:	Speakon
--------------------------	---------

#### Standard compliance

Safety agency:	CE compliant
----------------	--------------

#### Physical specifications

Cabinet/Case Material:	PP Composite
Hardware:	Integrated array mechanics
Handles:	2 on the rear panel
Grille:	Steel
Color:	Black - RAL 9005
Dimensions (H x W x D):	9.33"x 18.5"x 14.84"   237 x 470 x 377 mm
Weight:	26.01 lb   11.8 kg

RESPONSE 1W/1m

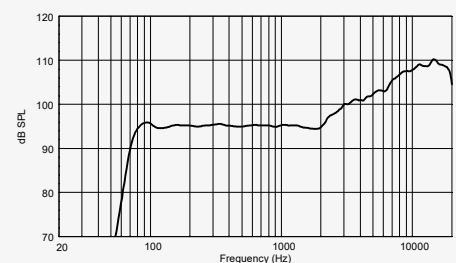

BEAMWIDTH vs. FREQUENCY

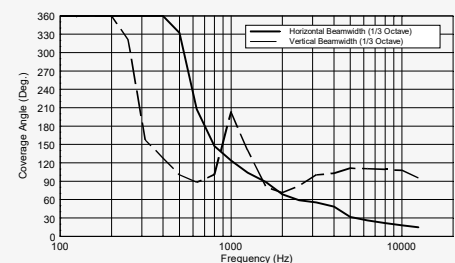

DIRECTIVITY INDEX AND Q

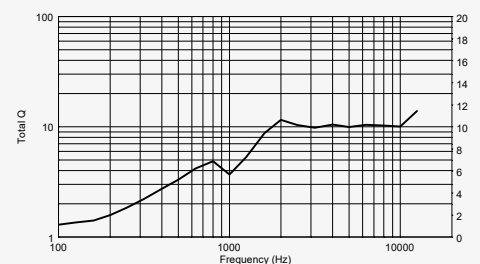

#### KRT-WH 6X HDL 6

p.n. 13360366

Kart with wheels for 6 HL 6.



#### PM-KIT 3X HDL 6

p.n. 13360377

Pole mount kit for 3 HL 6.  
Pins included. + Stacking Bar.



#### FL-B LINK HDL 6-12 2X

p.n. 13360375

Link bar for HL 6-A and HL 35-S (two pieces).



#### QL-PIN D9.6 L21.3 4X

p.n. 13360219

4 quick front lock pins kit for array system.

# 35 HL SERIES



## HL 35-S

### FLYABLE SUBWOOFER

The HL 35-S is the ideal flyable bass complement for the HL 6 array system. It features a Baltic birch plywood cabinet housing one 4.0" voice coil, 15" neodymium woofer to handle frequencies from 40 Hz to 140 Hz with the maximum linearity and lowest distortion. The hardware is designed for an easy and fast setup, completely compatible with the HL 6 rigging. The heavy-duty front grille is powder coated. A special transparent-to-sound foam backing inside helps to further protect the transducers from dust.

- 134 dB max SPL
- 40 ÷ 140 Hz frequency range
- 1 x 15" high-power woofer
- Baltic birch plywood cabinet
- Steel front grille with clothing
- M20 standard pole mount in the top section of the cabinet
- 2 x SPEAKON connectors

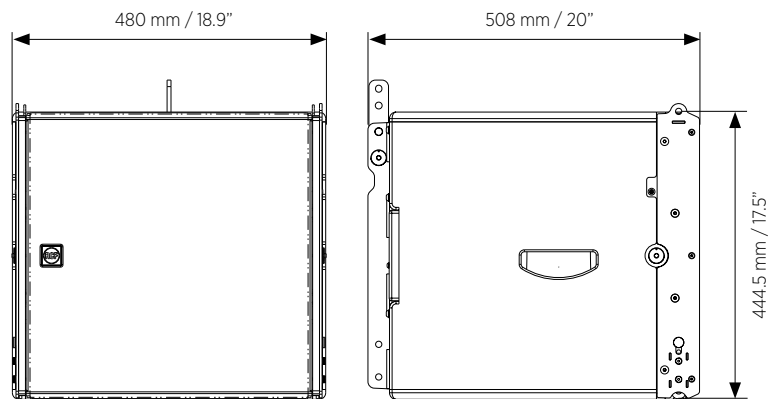

### RELATED ACCESSORIES



#### FL-B HDL 6

p.n. 13360360

Flybar for HL 6; HL 35-S + 1x Pickup Tab with Shackle + Stacking Bar + Pole Mount + M20 Adapter. Pins included.



#### AZM-BR 2X

p.n. 13360351

Azimuth bracket. 2 pieces. To be added for horizontal array control.



#### FL-B LINK HDL 6-12 2X

p.n. 13360375

Link bar for HL 6-A and HL 35-S (two pieces).



#### CL-BR HDL 6

p.n. 13360371

Clamp bracket



#### FL-B PK HDL 6

p.n. 13360372

Pickup Tab with Shackle for HL 6; HL 35-S. To be added to the flybar when rigging with 2 motors. Pins included.



## SPECIFICATIONS

### HL 35-S

p.n. 13000732

#### Acoustical specifications

Frequency Response (-10dB):	40 Hz ÷ 140 Hz
Max SPL @ 1m:	134 dB

#### Power section

Amplification:	Full Range
Nominal Impedance:	8 ohm
Power Handling:	900 W
Peak Power Handling:	3600 W PEAK
Recommended Amplifier:	1800 W

#### Transducers

Woofer:	15" neo, 4.0" v.c
---------	-------------------

#### Input/Output section

Input connectors:	Speakon
Output connectors:	Speakon

#### Standard compliance

Safety agency:	CE compliant
----------------	--------------

#### Physical specifications

Cabinet/Case Material:	Baltic birch plywood
Hardware:	Integrated array mechanics
Handles:	On side panels
Pole mount/Cap:	Yes
Grille:	Steel
Color:	Black - RAL 9005
Dimensions (H x W x D):	17.5"x 18.9"x 20"   444.5 x 480 x 508 mm
Weight:	61.73 lb   28 kg

RESPONSE 1W/1m

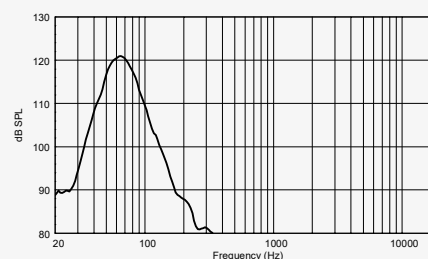

**QL-PIN D9.6 L21.3 4X** p.n. 13360219

4 quick front lock pins kit for array system.



**PM-KIT M20** p.n. 13360067

Adjustable pole for subwoofer.



**AC PMA** p.n. 13360034

Adjustable speaker pole



**AC PMX** p.n. 13360232

Adjustable pole - maximum load 50Kg

# 1315

## HL SERIES

### H 1315 WP

THREE WAY INDOOR/OUTDOOR HORN  
LOADED SPEAKER SYSTEM



The RCFACUSTICA H1315 WP is a three-way full range loudspeaker system that incorporates a 15" woofer, a 10" midrange and a 1.4" exit titanium compression driver for long throw applications. The system is very compact and provides very high output and accurate voice and sound reproduction. The system is equipped with the latest generation of RCF precision transducers, all of them with powerful neodymium motors. The internal passive filter provides crossover and equalization between the midrange and the compression driver. The system is driven in bi-amped mode, is capable of producing a Max SPL of 136 dB and handles 900 Watts AES (LF) + 400 Watt AES (MF/HF). The loudspeaker enclosure shape is multi-trapezoidal and offers a double coupling angle each side. Connections to the amplifier are made through a watertight multi-pole connector. The grille is in custom perforated aluminum with open-cell fibers and water repellent woven fabric backing. The cabinet is constructed of multi-ply baltic birch plywood and finished in a very resistant, textured, polyurea black paint.

The H 1315 WP cabinet is treated inside-outside with polyurea black paint. The cabinet includes 2 recessed handles for transportation and positioning and a total of six double M10 fixing point for flown applications and extensive internal metal bracing. The front steel grille is epoxy powder coated, and equipped with two layers of weather-resistant open-cell fibres and water repellent woven fabric backing. The transducer cones as well carry a special additional treatment to resist against critical environmental conditions. It is equipped with an IP 67 removable Amphenol terminal.

- 1300 W RMS power handling
- 136 dB max SPL
- 50 ÷ 20000 Hz frequency range
- Fully Horn-loaded, 60° x 40° directivity
- 15" neodymium woofer, 4.0" v.c.
- 10" neodymium midrange, 3.0" v.c.
- 3.0" v.c. neodymium compression driver
- Active Mosfet Compression Driver Protection
- Rotable HF Horn

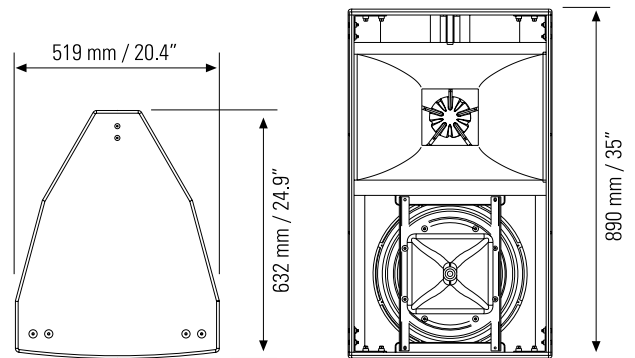

#### RELATED ACCESSORIES

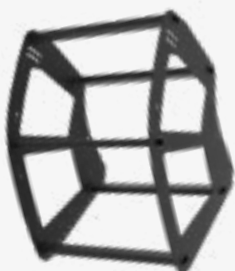

**C-BR H 1315** p.n. 33183006  
Cluster Flybar for 2 x  
H 1315 WP







## SPECIFICATIONS

### H 1315 WP

p.n. 13000266

#### Acoustical specifications

Frequency Response (-10dB):	50 Hz ÷ 20000 Hz
Frequency Response (-3dB):	65 Hz ÷ 20000 Hz
Max SPL @ 1m:	136 dB
Horizontal coverage angle:	60°
Vertical coverage angle:	40°
Directivity index Q:	12

#### Power section

Amplification:	Bi-Amp
Crossover Frequencies:	Recommended 300 Hz
Nominal Impedance LF:	8 ohm
Power Handling LF:	900 W
Peak Power Handling LF:	3600 W
Recommended Amplifier LF:	1800 W
Sensitivity LF:	100 dB
Nominal Impedance MF+HF:	8 ohm
Power Handling MF+HF:	400 W
Peak Power Handling MF+HF:	1600 W
Recommended Amplifier MF+HF:	800 W
Sensitivity MF + HF:	108 dB
Protections MF+HF:	Active mosfet compression driver
Crossover Frequencies:	1300 Hz

#### Transducers

Compression Driver:	1 x 1.4" neo, 3.0" v.c
Midrange:	10" neo, 3.0" v.c
Woofer:	15" neo, 4.0" v.c

#### Input/Output section

Input connectors:	Amphenol eco/mat IP 67
Output connectors:	Amphenol eco/mat IP 67

#### Standard compliance

Safety agency:	CE compliant
----------------	--------------

#### Physical specifications

Cabinet/Case Material:	Baltic birch plywood
Hardware:	12 x M10 rigging point
Handles:	2 recessed
Grille:	Steel
Color:	Black
Dimensions (H x W x D):	35.03"x 20.43"x 24.88"   890 x 519 x 632 mm
Weight:	114.64 lbs   52 kg

RESPONSE 1W/1m

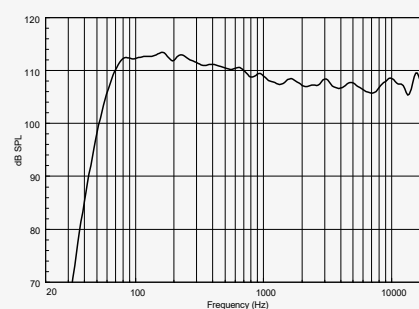

BEAMWIDTH vs. FREQUENCY

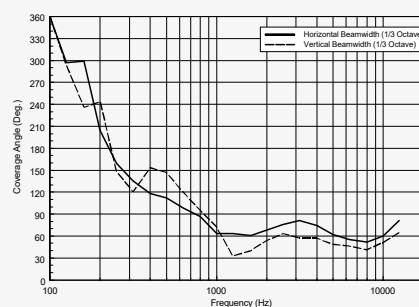

DIRECTIVITY INDEX AND Q

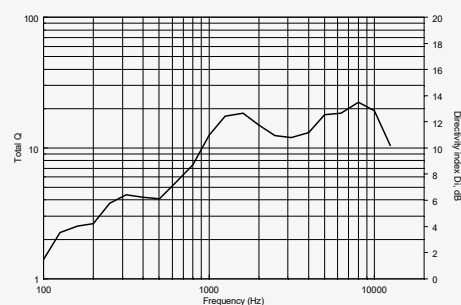

# 15

## HVL SERIES

### HVL 15-P

LONG THROW THREE-WAY SYSTEM



HVL 15-P is a three-way, bi-amp loudspeaker system for long-throw applications, outfitted with 2 x 15" woofers, 2 x 10" midranges, and 2 x 4.0" voice coil, titanium dome compression drivers. Equipped with the latest generation of RCF precision transducers with powerful neodymium magnets, HVL 15-P provides very high output and accurate sound and voice reproduction. The system, driven in bi-amped mode, can produce a max SPL of 144 dB MHF, handling 1000 W RMS (LF) + 900 W RMS (MHF). An internal passive filter provides crossover and equalization between the midranges and the compression drivers. The horizontal coverage is 45°, and the vertical coverage is 15°. A heavy-duty, weatherproof barrier strip provides connections. The cabinet is made of Baltic birch plywood. The finishing is a waterproof, textured, polyurea coating. The grille is in epoxy coated heavy-duty steel with open-cell fibers and water repellent woven-fabric backing.

- 1000 W (LF) + 900 W (MHF) AES power handling
- 145 dB max SPL
- 43 ÷ 18000 Hz frequency range
- 45° x 15° coverage angles
- Fully equipped with neodymium transducers
- Bi-amped system with passive filter between MF and HF
- Horn Loaded symmetric design
- Baltic birch plywood cabinet and steel grille
- Waterproof treatment

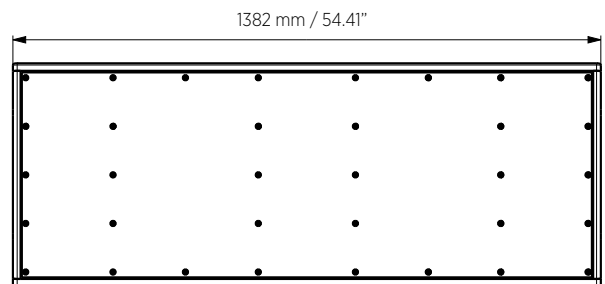
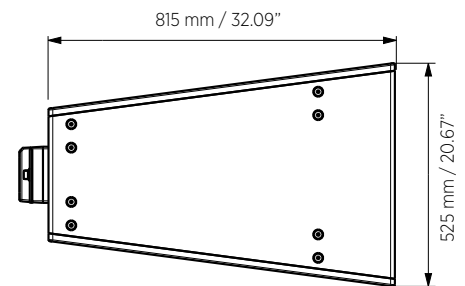

### PRECISION TRANSDUCERS

With in-house transducers' design and manufacturing for no-compromise performances, the HVL Series excels in any comparison. All transducers feature state of the art neodymium magnetic circuits, radically new voice coil ventilation systems, and ground-breaking voice coil assemblies.





## SPECIFICATIONS

### HVL 15-P

p.n. 13000565 (White) - p.n. 13000746 (Black)

#### Acoustical specifications

Frequency Response (-10dB):	43 Hz ÷ 18000 Hz
Frequency Response (-3dB):	59 Hz ÷ 13000 Hz
Max SPL @ 1m:	148 dB
Horizontal coverage angle:	45°
Vertical coverage angle:	15°
Directivity index Q:	18
System Sensitivity:	111 dB

#### Power section

Amplification:	Bi-Amp
Nominal Impedance LF:	8 ohm
Power Handling LF:	1000 W
Peak Power Handling LF:	4000 W
Recommended Amplifier LF:	2000 W
Sensitivity LF:	97 dB
Nominal Impedance MF+HF:	8 ohm
Power Handling MF+HF:	900 W
Peak Power Handling MF+HF:	3600 W
Recommended Amplifier MF+HF:	1800 W
Sensitivity MF + HF:	111 dB
Protections MF+HF:	Dynamic Active Mosfet
Crossover Frequencies:	1000 Hz

#### Transducers

Compression Driver:	2 x 1.4" neo, 4.0" v.c
Midrange:	2 x 10" neo, 3.0" v.c
Woofer:	2 x 15" neo, 3.5" v.c

#### Input/Output section

Input/Output connectors:	Screw Terminals
--------------------------	-----------------

#### Standard compliance

Safety agency:	CE compliant
----------------	--------------

#### Physical specifications

Cabinet/Case Material:	Baltic birch plywood
Hardware:	n° 8 x M20 on each side panel n° 8 x M20 on top and bottom panel
Grille:	Steel
Color:	White - RAL 9010, Black - RAL 9005
Dimensions (H x W x D):	20.67"x 54.41"x 32.09"   525 x 1382 x 815 mm
Weight:	115 kg   253.53 lbs

RESPONSE 1W/1m

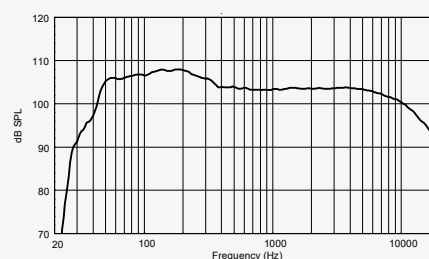

BEAMWIDTH vs. FREQUENCY

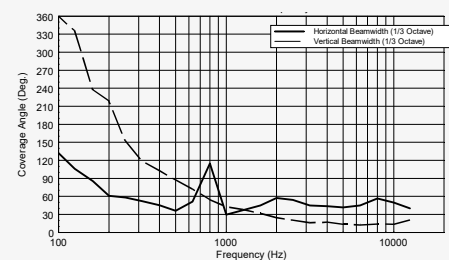

DIRECTIVITY INDEX AND Q

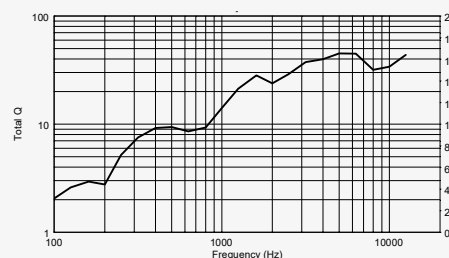

# 15

## HVL SERIES

### HVL 15-P1

LONG THROW THREE-WAY SYSTEM



HVL 15-P1 is a three-way, bi-amp loudspeaker system for long-throw applications, outfitted with 2 x 15" woofers, 2 x 10" midranges, and 2 x 4.0" voice coil, titanium dome compression drivers. Equipped with the latest generation of RCF precision transducers with powerful neodymium magnets, HVL 15-P1 provides very high output and accurate sound and voice reproduction. The system, driven in bi-amped mode, can produce a max SPL of 144 dB MHF, handling 1000 W RMS (LF) + 900 W RMS (MHF). An internal passive filter provides crossover and equalization between the midranges and the compression drivers. The horizontal coverage is 60°, and the vertical coverage is 30°. A heavy-duty, weatherproof barrier strip provides connections. The cabinet is made of Baltic birch plywood. The finishing is a waterproof, textured, polyurea coating. The grille is in epoxy coated heavy-duty steel with open-cell fibers and water repellent woven-fabric backing.

- 1000 W (LF) + 900 W (MHF) AES power handling
- 144 dB max SPL
- 43 ÷ 18000 Hz frequency range
- 60° x 30° coverage angles
- Fully equipped with neodymium transducers
- Bi-amped system with passive filter between MF and HF
- Horn Loaded symmetric design
- Baltic birch plywood cabinet and steel grille
- Waterproof treatment

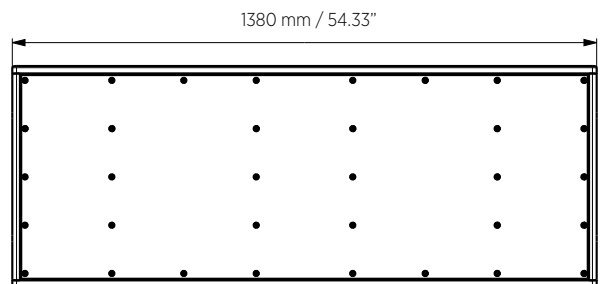
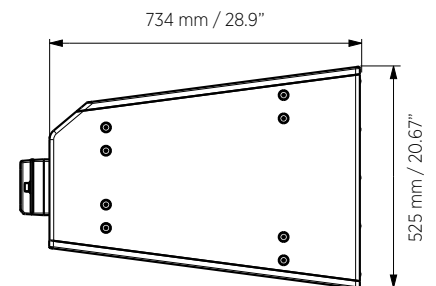

#### 4PATH WAVEGUIDE

The custom 4 PATH-designed waveguide allows precise coverage while also delivering an excellent, linear high-frequency response. The unique shape of the four ducts forming the guide creates an ideal isophasic load from the vocal range up to the highest audible frequencies.

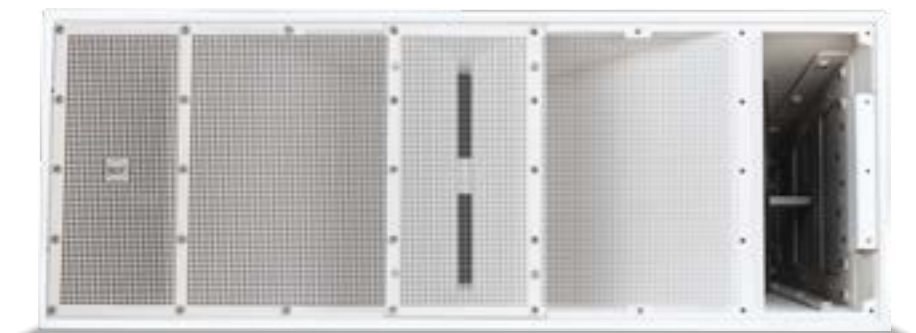



## SPECIFICATIONS

### HVL 15-P1

p.n. 13000700 (White) - p.n. 13000748 (Black)

#### Acoustical specifications

Frequency Response (-10dB):	43 Hz ÷ 18000 Hz
Frequency Response (-3dB):	59 Hz ÷ 13000 Hz
Max SPL @ 1m:	148 dB
Horizontal coverage angle:	60°
Vertical coverage angle:	30°
Directivity index Q:	15
System Sensitivity:	111 dB

#### Power section

Amplification:	Bi-Amp
Nominal Impedance LF:	8 ohm
Power Handling LF:	1000 W
Peak Power Handling LF:	4000 W
Recommended Amplifier LF:	2000 W
Sensitivity LF:	97 dB
Nominal Impedance MF+HF:	8 ohm
Power Handling MF+HF:	900 W
Peak Power Handling MF+HF:	3600 W
Recommended Amplifier MF+HF:	1800 W
Sensitivity MF + HF:	111 dB
Protections MF+HF:	Dynamic Active Mosfet
Crossover Frequencies:	1000 Hz

#### Transducers

Compression Driver:	2 x 1.4" neo, 4.0" v.c
Midrange:	2 x 10" neo, 3.0" v.c
Woofer:	2 x 15" neo, 3.5" v.c

#### Input/Output section

Input/Output connectors:	Screw Terminals
--------------------------	-----------------

#### Standard compliance

Safety agency:	CE compliant
----------------	--------------

#### Physical specifications

Cabinet/Case Material:	Baltic birch plywood
Hardware:	n° 8 x M20 on each side panel n° 8 x M20 on top and bottom panel
Grille:	Steel
Color:	White - RAL 9010, Black - RAL 9005
Dimensions (H x W x D):	20.67"x 54.33"x 28.9"   525 x 1380 x 734 mm
Weight:	110 kg   242.51 lbs

RESPONSE 1W/1m

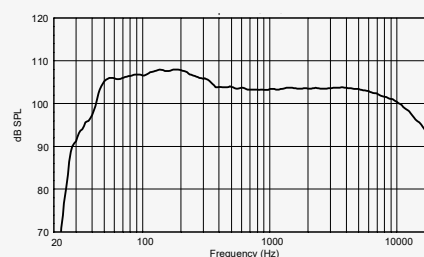

BEAMWIDTH vs. FREQUENCY

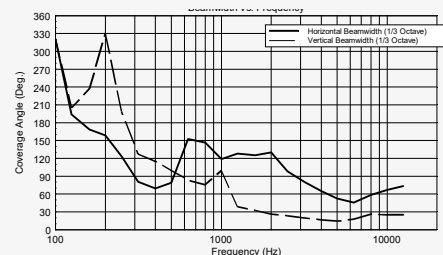

DIRECTIVITY INDEX AND Q

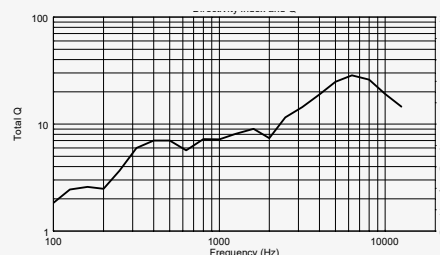

# 15

## HVL SERIES

### HVL 15-L

LONG THROW THREE-WAY SYSTEM



HVL 15-L is a three-way, bi-amp loudspeaker system for long-throw applications, outfitted with 2 x 15" woofers, 2 x 10" midranges, and 2 x 4.0" voice coil, titanium dome compression drivers. Equipped with the latest generation of RCF precision transducers with powerful neodymium magnets, HVL 15-L provides very high output and accurate sound and voice reproduction. The system, driven in bi-amped mode, can produce a max SPL of 144 dB, handling 1000 W RMS (LF) + 900 W RMS (MHF). An internal passive filter provides crossover and equalization between the midranges and the compression drivers. The horizontal coverage is 90°, and the vertical coverage is 30°. A heavy-duty, weatherproof barrier strip provides connections. The cabinet is made of Baltic birch plywood. The finishing is a waterproof, textured, polyurea coating. The grille is in epoxy coated heavy-duty steel with open-cell fibers and water repellent woven-fabric backing.

- 1000 W (LF) + 900 W (MHF) AES power handling
- 144 dB max SPL
- 43 ÷ 18000 Hz frequency range
- 90° x 30° coverage angles
- Fully equipped with neodymium transducers
- Bi-amped system with passive filter between MF and HF
- Horn Loaded symmetric design
- Baltic birch plywood cabinet and steel grille
- Waterproof treatment

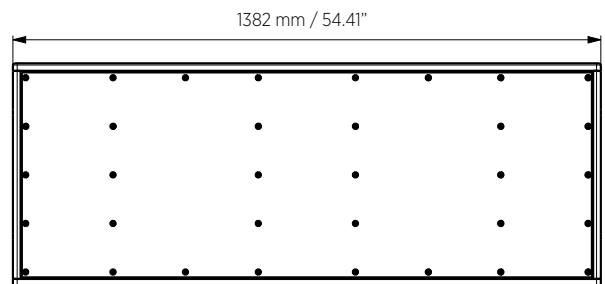
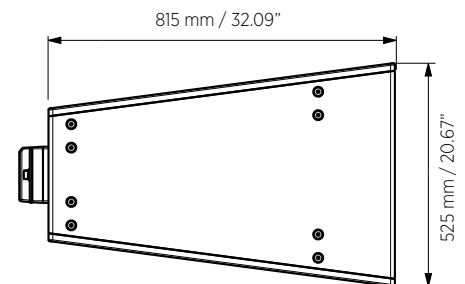

### LONG THROW APPLICATIONS

Focusing on stadiums and big arenas, HVL Series speakers are capable of true, concert-level high performance in arena-sized venues. Featuring point source, line source, and subwoofers speakers, all modules embed RCF Precision Transducers, horns, and waveguides for optimal coverage and clarity. The cabinet's design with coplanar woofers and horns produces identical left and right coverage, capable of delivering serious sonic horsepower within the stadium while maintaining intelligibility and even coverage at every seat.

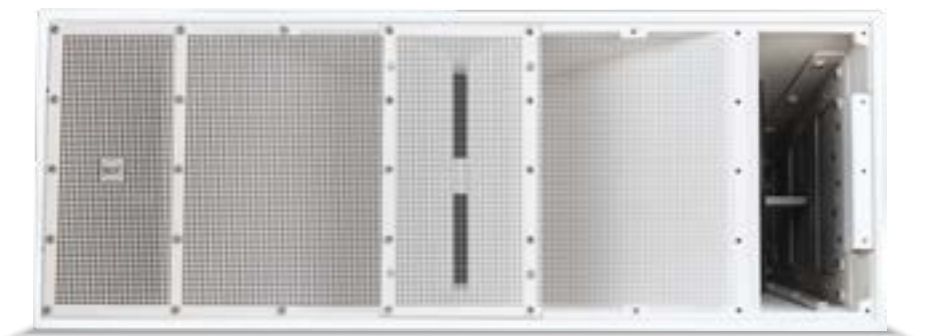



## SPECIFICATIONS

### HVL 15-L

p.n. 13000640 (White) - p.n. 13000747 (Black)

#### Acoustical specifications

Frequency Response (-10dB):	43 Hz ÷ 18000 Hz
Frequency Response (-3dB):	59 Hz ÷ 13000 Hz
Max SPL @ 1m:	147 dB
Horizontal coverage angle:	90°
Vertical coverage angle:	30°
Directivity index Q:	12
System Sensitivity:	110 dB

#### Power section

Amplification:	Bi-Amp
Nominal Impedance LF:	8 ohm
Power Handling LF:	1000 W
Peak Power Handling LF:	4000 W
Recommended Amplifier LF:	2000 W
Sensitivity LF:	97 dB
Nominal Impedance MF+HF:	8 ohm
Power Handling MF+HF:	900 W
Peak Power Handling MF+HF:	3600 W
Recommended Amplifier MF+HF:	1800 W
Sensitivity MF + HF:	111 dB
Protections MF+HF:	Dynamic Active Mosfet
Crossover Frequencies:	1000 Hz

#### Transducers

Compression Driver:	2 x 1.4" neo, 4.0" v.c
Midrange:	2 x 10" neo, 3.0" v.c
Woofer:	2 x 15" neo, 3.5" v.c

#### Input/Output section

Input/Output connectors:	Screw Terminals
--------------------------	-----------------

#### Standard compliance

Safety agency:	CE compliant
----------------	--------------

#### Physical specifications

Cabinet/Case Material:	Baltic birch plywood
Hardware:	n° 8 x M20 on each side panel n° 8 x M20 on top and bottom panel
Grille:	Steel
Color:	White - RAL 9010, Black - RAL 9005
Dimensions (H x W x D):	20.67"x 54.41"x 32.09"   525 x 1382 x 815 mm
Weight:	110 kg   242.51 lbs

RESPONSE 1W/1m

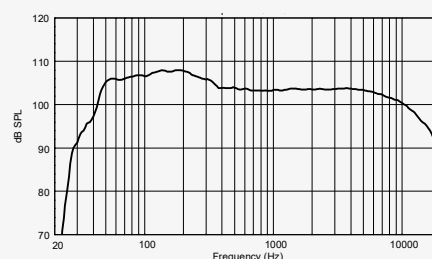

BEAMWIDTH vs. FREQUENCY

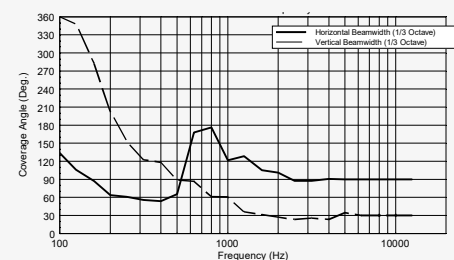

DIRECTIVITY INDEX AND Q

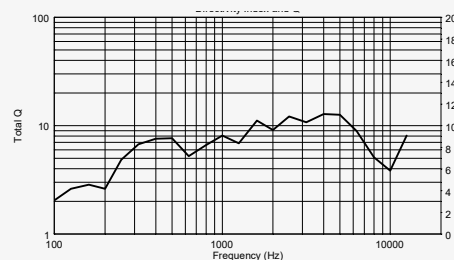

# 15

## HVL SERIES

### HVL 15-L1

LONG THROW THREE-WAY SYSTEM



HVL 15-L1 is a three-way, bi-amp loudspeaker system for long-throw applications, outfitted with 2 x 15" woofers, 2 x 10" midranges, and 2 x 4.0" voice coil, titanium dome compression drivers. Equipped with the latest generation of RCF precision transducers with powerful neodymium magnets, HVL 15-L1 provides very high output and accurate sound and voice reproduction. The system, driven in bi-amped mode, can produce a max SPL of 144 dB MHF, handling 1000 W RMS (LF) + 900 W RMS (MHF). An internal passive filter provides crossover and equalization between the midranges and the compression drivers. The horizontal coverage is 90°, and the vertical coverage is 30°. A heavy-duty, weatherproof barrier strip provides connections. The cabinet is made of Baltic birch plywood. The finishing is a waterproof, textured, polyurea coating. The grille is in epoxy coated heavy-duty steel with open-cell fibers and water repellent woven-fabric backing. The back of the cabinet is shaped for under-balcony installation.

- 1000 W (LF) + 900 W (MHF) AES power handling
- 144 dB max SPL
- 43 ÷ 18000 Hz frequency range
- 90° x 30° coverage angles
- Fully equipped with neodymium transducers
- Bi-amped system with passive filter between MF and HF
- Horn Loaded symmetric design
- Baltic birch plywood cabinet and steel grille
- Waterproof treatment

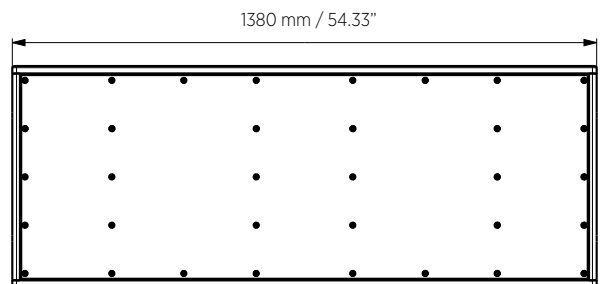
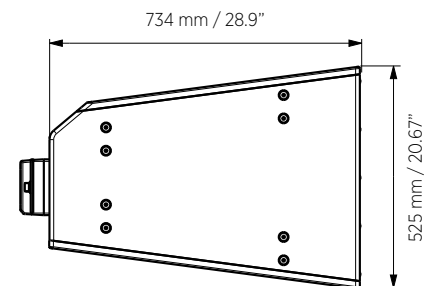





## SPECIFICATIONS

### HVL 15-L1

p.n. 13000701 (White) - p.n. 13000749 (Black)

#### Acoustical specifications

Frequency Response (-10dB):	43 Hz ÷ 18000 Hz
Frequency Response (-3dB):	59 Hz ÷ 13000 Hz
Max SPL @ 1m:	147 dB
Horizontal coverage angle:	90°
Vertical coverage angle:	30°
Directivity index Q:	12
System Sensitivity:	110 dB

#### Power section

Amplification:	Bi-Amp
Nominal Impedance LF:	8 ohm
Power Handling LF:	1000 W
Peak Power Handling LF:	4000 W
Recommended Amplifier LF:	2000 W
Sensitivity LF:	97 dB
Nominal Impedance MF+HF:	8 ohm
Power Handling MF+HF:	900 W
Peak Power Handling MF+HF:	3600 W
Recommended Amplifier MF+HF:	1800 W
Sensitivity MF + HF:	111 dB
Protections MF+HF:	Dynamic Active Mosfet
Crossover Frequencies:	1000 Hz

#### Transducers

Compression Driver:	2 x 1.4" neo, 4.0" v.c
Midrange:	2 x 10" neo, 3.0" v.c
Woofer:	2 x 15" neo, 3.5" v.c

#### Input/Output section

Input/Output connectors:	Screw Terminals
--------------------------	-----------------

#### Standard compliance

Safety agency:	CE compliant
----------------	--------------

#### Physical specifications

Cabinet/Case Material:	Baltic birch plywood
Hardware:	n° 8 x M20 on each side panel n° 8 x M20 on top and bottom panel
Grille:	Steel
Color:	White - RAL 9010, Black - RAL 9005
Dimensions (H x W x D):	20.67"x 54.33"x 28.9"   525 x 1380 x 734 mm
Weight:	110 kg   242.51 lbs

RESPONSE 1W/1m

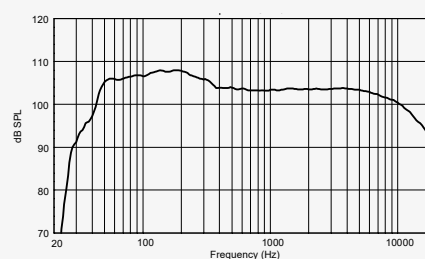

BEAMWIDTH vs. FREQUENCY

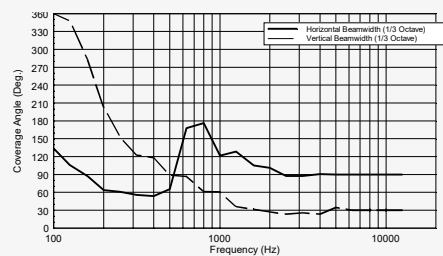

DIRECTIVITY INDEX AND Q

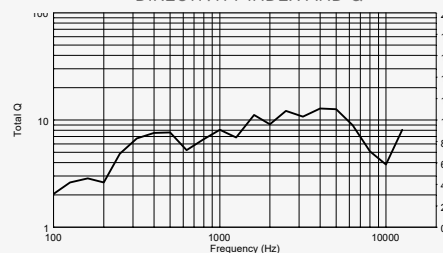

# 15

## HVL SERIES

### HVL 15-S

BANDPASS SUBWOOFER SYSTEM

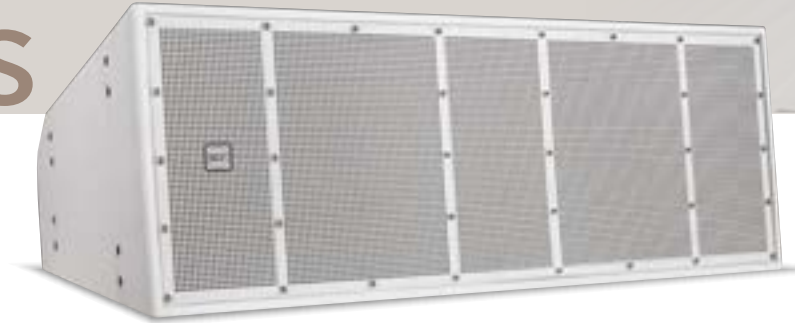

HVL 15-S is a double 15" subwoofer system for long-throw applications, outfitted with 2 x 15" woofers. Equipped with the latest generation of RCF precision transducers with powerful neodymium magnets, HVL 15-S provides very high output and accurate sound reproduction. The system can produce a max SPL of 133 dB, handling 3000 W. The enclosure is trapezoidal with a coupling angle of 15°. The cabinet is made of Baltic birch plywood, and the finishing is a waterproof, textured, polyurea coating. A heavy-duty, weatherproof barrier strip provides connections. The grille is in epoxy coated heavy-duty steel with open-cell fibers and water repellent woven-fabric backing.

- 3000 W AES power handling
- 133 dB max SPL
- 33 ÷ 180 Hz frequency range
- 2 x 15" high-power woofers
- Symmetric design
- Baltic birch plywood cabinet and steel grille
- Waterproof treatment

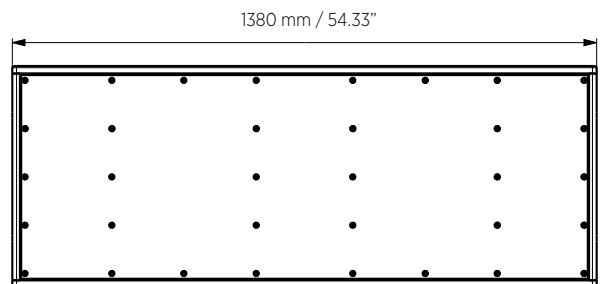
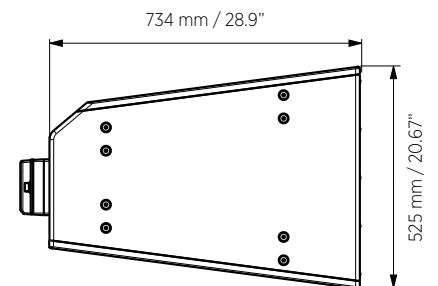



**SPECIFICATIONS**

**HVL 15-S**

p.n. 13000705 (White) - p.n. 13000750 (Black)

**Acoustical specifications**

Frequency Response (-10dB):	33 Hz ÷ 180 Hz
Frequency Response (-3dB):	40 Hz ÷ 150 Hz
Max SPL @ 1m:	133 dB
System Sensitivity:	97 dB

**Power section**

Amplification:	Full Range
Nominal Impedance:	8 ohm
Power Handling:	3000 W
Peak Power Handling:	12000 W
Recommended Amplifier:	6000 W

**Transducers**

Woofers:	2 x 15", 4.0" v.c
----------	-------------------

**Input/Output section**

Input/Output connectors:	Screw Terminals
--------------------------	-----------------

**Standard compliance**

Safety agency:	CE compliant
----------------	--------------

**Physical specifications**

Cabinet/Case Material:	Baltic birch plywood
Hardware:	n° 8 x M20 on each side panel n° 8 x M20 on top and bottom panel
Grille:	Steel
Color:	White - RAL 9010, Black - RAL 9005
Dimensions (H x W x D):	20.67"x 54.33"x 28.9"   525 x 1380 x 734 mm
Weight:	110 kg   242.51 lbs

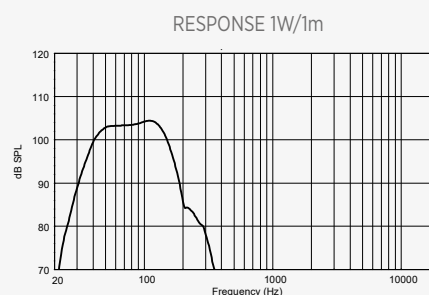

**CONSISTENT ROBUSTNESS**

Reduce the commissioning time on your new projects with HVL's modular array-ability, multiple directivity indexes (Q), and small footprint in comparison to its power. HVL can lower overall system costs by delivering full coverage with fewer modules precisely matching the audience area. Rated for direct-exposure outdoor installations, each cabinet is made of Baltic birch plywood with polyurea coating and includes a weatherproof barrier strip for connections. The grille is powder-coated heavy-duty steel with open-cell fibers and water repellent woven-fabric backing.

# Q15

## Q 15 SERIES

### Q 15

#### TWO-WAY POINT SOURCE MODULE

Q 15 is a two-way, bi-amp point source module for mid-distance and long-throw applications, combining a compact size with very high output and accurate speech and music reproduction. The system is equipped with the latest generation of RCF precision transducers featuring one 15" neodymium woofer and a 4" titanium-neodymium compression driver for a total of 1500 W power rating and 60° (vertical) and 22.5° (horizontal) directivity. The enclosure shape is trapezoidal and offers a 22.5° coupling angle on each side.

Q Series typical applications span from point-source configurations for mid-distance applications to clusters up to 8 modules for long-throw applications. The grille is epoxy-coated, with a woven fabric backing for dust protection. The cabinet is made of multi-ply Baltic birch plywood with a highly resistant, textured, black polyurea finishing and features two rear-panel Neutrik Speakon NL4 connections for bi-amplification (4 poles).



- 138 dB Max SPL
- 1500 W AES power handling
- 45 ÷ 20000 Hz
- 22.5° x 60° constant directivity coverage
- 1 x 15" neodymium woofer, 4.0" v.c.
- 4" neodymium compression driver
- Baltic birch plywood cabinet
- Steel front grille with clothing
- Integrated array mechanics
- Multi-pole Speakon connectors

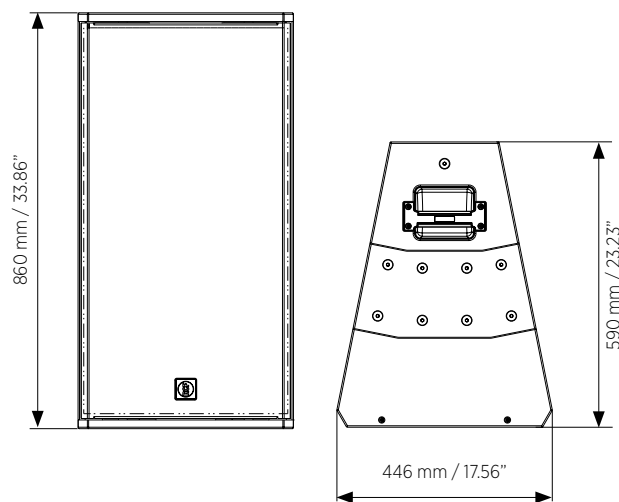

#### RELATED ACCESSORIES

##### C-BR 10° Q 15

p.n. 13360487



C-BR Q 15 is a flying bracket that allows to install Q 15 modules with a coupling angle of 10°, instead of the native 22.5°. It shall be used in combination with the vertical fly bar FL-B V Q 15.

##### FLY BAR FL-B H Q 15

p.n. 13360456



FL-B H Q 15 is an accessory that allow to create a horizontal cluster of Q 15 speakers. Thanks to the mechanics integrated in the speaker, it is easy to create an array with up to 4 modules for each bar.



##### PNL IN-OUT AMPHENOL

p.n. 12399063

PNL IN-OUT AMPHENOL is an optional panel that allows to switch input/output connectors to AMPHENOL IP 67, making them fully weatherproof

##### FLY BAR FL-B V Q 15

p.n. 13360457



FL-B V Q 15 is an accessory that allow to create a vertical cluster of Q 15 speakers. Thanks to the mechanics integrated in the speaker, it is easy to create an array with up to 8 modules, using one or two bars depending on the desired configuration.



**SPECIFICATIONS**

**Q 15**

p.n. 13000698

**Acoustical specifications**

Frequency Response (-10dB):	45 Hz ÷ 20000 Hz
Max SPL @ 1m:	138 dB
Horizontal coverage angle:	22.5°
Vertical coverage angle:	60°
Directivity index Q:	20

**Power section**

Amplification:	Bi-Amp
Nominal Impedance LF:	8 ohm
Power Handling LF:	1350 W
Peak Power Handling LF:	5400 W
Recommended Amplifier LF:	2700 W
Sensitivity LF:	97 dB
Nominal Impedance HF:	8 ohm
Power Handling HF:	150 W
Peak Power Handling HF:	600 W
Recommended Amplifier HF:	300 W
Sensitivity HF:	113 dB
Protections HF:	Capacitor on Compression Driver

**Transducers**

Compression Driver:	1 x 1.4" neo, 4.0" v.c
Woofer:	15" neo, 4.0" v.c

**Input/Output section**

Input connectors:	Speakon® NL4
Output connectors:	Speakon® NL4

**Standard compliance**

Safety agency:	CE compliant
----------------	--------------

**Physical specifications**

Cabinet/Case Material:	Baltic birch plywood
Hardware:	Side and rear array rigging point
Handles:	2
Grille:	Steel
Color:	Black - RAL 9005
Dimensions (H x W x D):	33.86" x 17.56" x 23.23"   860 x 446 x 590 mm
Weight:	121.25 lbs   55 kg

RESPONSE 1W/1m

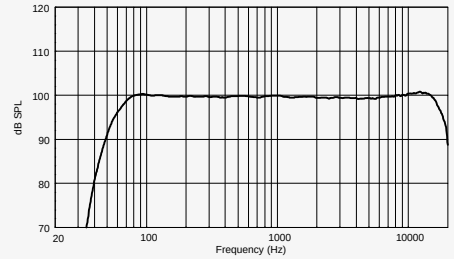

BEAMWIDTH vs. FREQUENCY

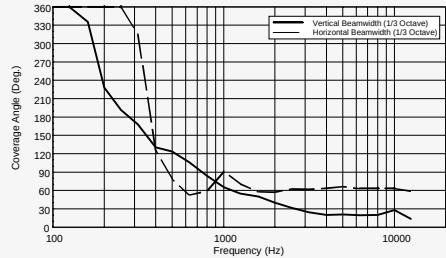

DIRECTIVITY INDEX AND Q

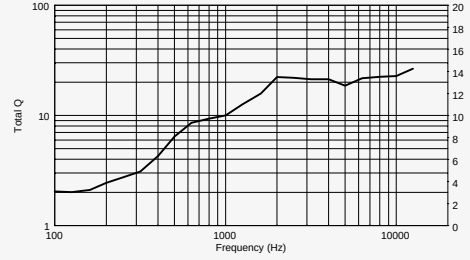

# Q15

## Q 15 SERIES

### Q 15-L

#### TWO-WAY POINT SOURCE MODULE

Q 15-L is a two-way, bi-amp point source module for mid-distance and long-throw applications, combining a compact size with very high output and accurate speech and music reproduction. The system is equipped with the latest generation of RCF precision transducers featuring one 15" neodymium woofer and a 4" titanium-neodymium compression driver for a total of 1500 W power rating and 90° (vertical) and 22.5° (horizontal) directivity. The enclosure shape is trapezoidal and offers a 22.5° coupling angle on each side.

Q Series typical applications span from pointsource configurations for mid-distance applications to clusters up to 8 modules for long-throw applications. The grille is Epoxy-coated, with a woven fabric backing for dust protection. The cabinet is made of multiply Baltic birch plywood with a highly resistant, textured, black polyurea finishing and features two rear-panel Neutrik Speakon NL4 connections for bi-amplification (4 poles).



- 138 dB Max SPL
- 1500 W AES power handling
- 45 ÷ 20000 Hz
- 22.5° x 90° constant directivity coverage
- 1 x 15" neodymium woofer, 4.0" v.c.
- 4" neodymium compression driver
- Baltic birch plywood cabinet
- Steel front grille with clothing
- Integrated array mechanics
- Multi-pole Speakon connectors

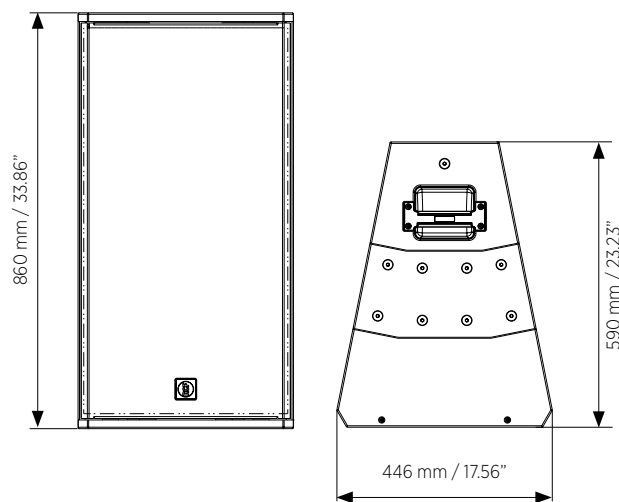

#### RELATED ACCESSORIES

##### C-BR 10° Q 15

p.n. 13360487



C-BR Q 15 is a flying bracket that allows to install Q 15 modules with a coupling angle of 10°, instead of the native 22.5°. It shall be used in combination with the vertical fly bar FL-B V Q 15.

##### FLY BAR FL-B H Q 15

p.n. 13360456



FL-B H Q 15 is an accessory that allow to create a horizontal cluster of Q 15 speakers. Thanks to the mechanics integrated in the speaker, it is easy to create an array with up to 4 modules for each bar.



##### PNL IN-OUT AMPHENOL

p.n. 12399063

PNL IN-OUT AMPHENOL is an optional panel that allows to switch input/output connectors to AMPHENOL IP 67, making them fully weatherproof

##### FLY BAR FL-B V Q 15

p.n. 13360457



FL-B V Q 15 is an accessory that allow to create a vertical cluster of Q 15 speakers. Thanks to the mechanics integrated in the speaker, it is easy to create an array with up to 8 modules, using one or two bars depending on the desired configuration.



## SPECIFICATIONS

### Q 15-L

p.n. 13000727

#### Acoustical specifications

Frequency Response (-10dB):	45 Hz ÷ 20000 Hz
Max SPL @ 1m:	138 dB
Horizontal coverage angle:	22.5°
Vertical coverage angle:	90°
Directivity index Q:	20

#### Power section

Amplification:	Bi-Amp
Crossover Frequencies:	600 Hz
Nominal Impedance LF:	8 ohm
Power Handling LF:	1350 W
Peak Power Handling LF:	5400 W
Recommended Amplifier LF:	2700 W
Sensitivity LF:	97 dB
Nominal Impedance HF:	8 ohm
Power Handling HF:	150 W
Peak Power Handling HF:	600 W
Recommended Amplifier HF:	300 W
Sensitivity HF:	113 dB
Protections HF:	Capacitor on Compression Driver

#### Transducers

Compression Driver:	1 x 1.4" neo, 4.0" v.c
Woofer:	15" neo, 4.0" v.c

#### Input/Output section

Input connectors:	Speakon® NL4
Output connectors:	Speakon® NL4

#### Standard compliance

Safety agency:	CE compliant
----------------	--------------

#### Physical specifications

Cabinet/Case Material:	Baltic birch plywood
Hardware:	Side and rear array rigging point
Handles:	2
Grille:	Steel
Color:	Black - RAL 9005
Dimensions (H x W x D):	33.86" x 17.56" x 23.23"   860 x 446 x 590 mm
Weight:	121.25 lbs   55 kg

RESPONSE 1W/1m

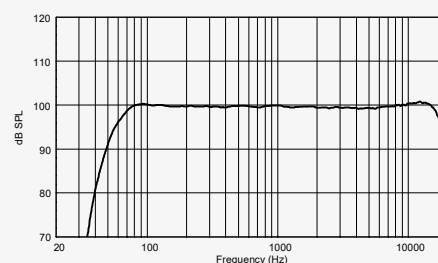

BEAMWIDTH vs. FREQUENCY

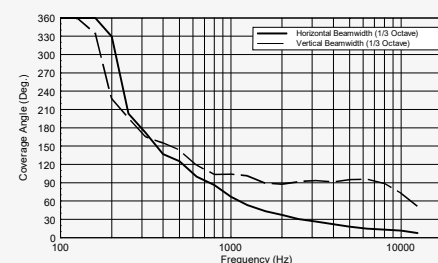

DIRECTIVITY INDEX AND Q

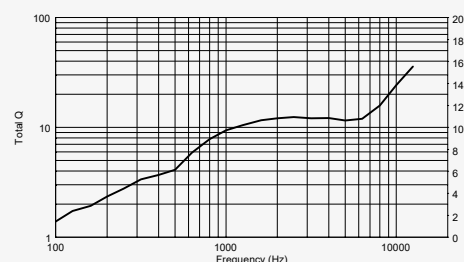

# Q15

## Q 15 SERIES

### Q 15-P

#### TWO-WAY POINT SOURCE MODULE

Q 15-P is a two-way, bi-amp point source module for mid-distance and long-throw applications, combining a compact size with very high output and accurate speech and music reproduction. The system is equipped with the latest generation of RCF precision transducers featuring one 15" neodymium woofer and a 4" titanium-neodymium compression driver for a total of 1500 W power rating and 40° (vertical) and 22.5° (horizontal) directivity. The enclosure shape is trapezoidal and offers a 22.5° coupling angle on each side. Q series typical applications span from pointsource configurations for mid-distance applications to clusters up to 8 modules for long-throw applications. The grille is Epoxy-coated, with a woven fabric backing for dust protection. The cabinet is made of multiply Baltic birch plywood with a highly resistant, textured, black polyurea finishing and features two rear-panel Neutrik Speakon NL4 connections for bi-amplification (4 poles).



- 138 dB Max SPL
- 1500 W AES power handling
- 45 ÷ 20000 Hz
- 22.5° x 40° constant directivity coverage
- 1 x 15" neodymium woofer, 4.0" v.c.
- 4" neodymium compression driver
- Baltic birch plywood cabinet
- Steel front grille with clothing
- Integrated array mechanics
- Multi-pole Speakon connectors

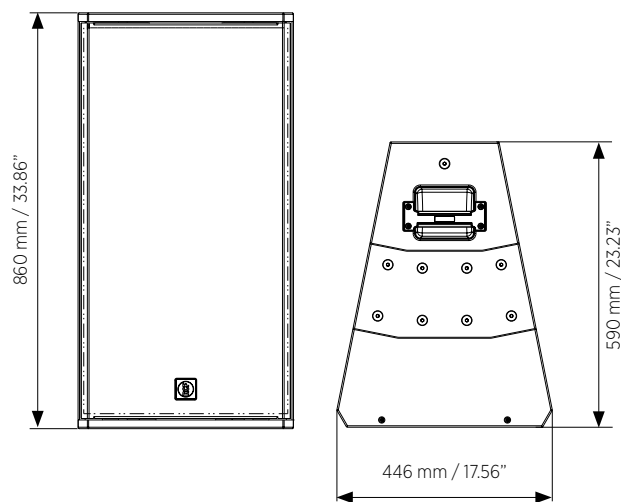

#### RELATED ACCESSORIES

##### C-BR 10° Q 15

p.n. 13360487



C-BR Q 15 is a flying bracket that allows to install Q 15 modules with a coupling angle of 10°, instead of the native 22.5°. It shall be used in combination with the vertical fly bar FL-B V Q 15.

##### FLY BAR FL-B H Q 15

p.n. 13360456



FL-B H Q 15 is an accessory that allow to create a horizontal cluster of Q 15 speakers. Thanks to the mechanics integrated in the speaker, it is easy to create an array with up to 4 modules for each bar.



##### PNL IN-OUT AMPHENOL

p.n. 12399063

PNL IN-OUT AMPHENOL is an optional panel that allows to switch input/output connectors to AMPHENOL IP 67, making them fully weatherproof

##### FLY BAR FL-B V Q 15

p.n. 13360457



FL-B V Q 15 is an accessory that allow to create a vertical cluster of Q 15 speakers. Thanks to the mechanics integrated in the speaker, it is easy to create an array with up to 8 modules, using one or two bars depending on the desired configuration.





## SPECIFICATIONS

### Q 15-P

p.n. 13000728

#### Acoustical specifications

Frequency Response (-10dB):	45 Hz ÷ 20000 Hz
Max SPL @ 1m:	138 dB
Horizontal coverage angle:	22.5°
Vertical coverage angle:	40°
Directivity index Q:	20

#### Power section

Amplification:	Bi-Amp
Crossover Frequencies:	600 Hz
Nominal Impedance LF:	8 ohm
Power Handling LF:	1350 W
Peak Power Handling LF:	5400 W
Recommended Amplifier LF:	2700 W
Sensitivity LF:	97 dB
Nominal Impedance HF:	8 ohm
Power Handling HF:	150 W
Peak Power Handling HF:	600 W
Recommended Amplifier HF:	300 W
Sensitivity HF:	113 dB
Protections HF:	Capacitor on Compression Driver

#### Transducers

Compression Driver:	1 x 1.4" neo, 4.0" v.c
Woofer:	15" neo, 4.0" v.c

#### Input/Output section

Input connectors:	Speakon® NL4
Output connectors:	Speakon® NL4

#### Standard compliance

Safety agency:	CE compliant
----------------	--------------

#### Physical specifications

Cabinet/Case Material:	Baltic birch plywood
Hardware:	Side and rear array rigging point
Handles:	2
Grille:	Steel
Color:	Black - RAL 9005
Dimensions (H x W x D):	33.86" x 17.56" x 23.23"   860 x 446 x 590 mm
Weight:	121.25 lbs   55 kg

RESPONSE 1W/1m

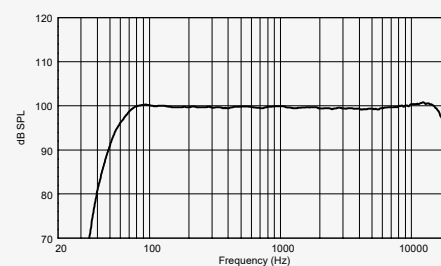

BEAMWIDTH vs. FREQUENCY

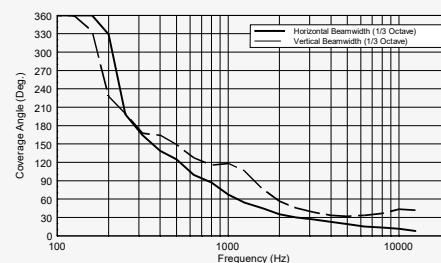

DIRECTIVITY INDEX AND Q

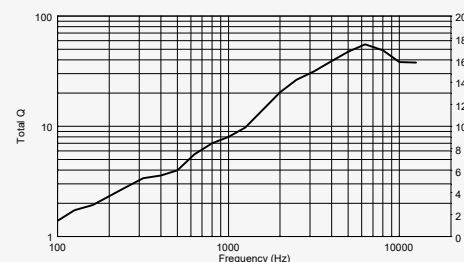

# C45

## C SERIES



### COMPACT C 45

#### TWO-WAY PROFESSIONAL SPEAKER

COMPACT C 45 is a multipurpose two-way point source speaker, suitable for a wide range of near and mid-distance applications. The combination of a 4" neodymium compression driver, a 15" neodymium woofer, and a constant directivity rotatable waveguide produces coherent 100° x 50° coverage for the listening area with high SPL, and distortion-free sound. The sleek and lightweight wood cabinet uses a special polyurea coating and a robust powder-coated grille with protective foam. Optional mounting accessories allow for wall or ceiling installation.

- 700 W power handling (RMS)
- 138 dB max SPL
- 48 ÷ 20000 Hz frequency range
- 100° x 50° constant directivity coverage angle
- 1 x 15" high power neodymium woofer
- 1 x 4.0" v.c. neodymium compression driver
- High quality birch plywood cabinet
- Steel front grille with clothing
- Installation points available on top, bottom, rear and side panels
- SPEAKON in/out connectors

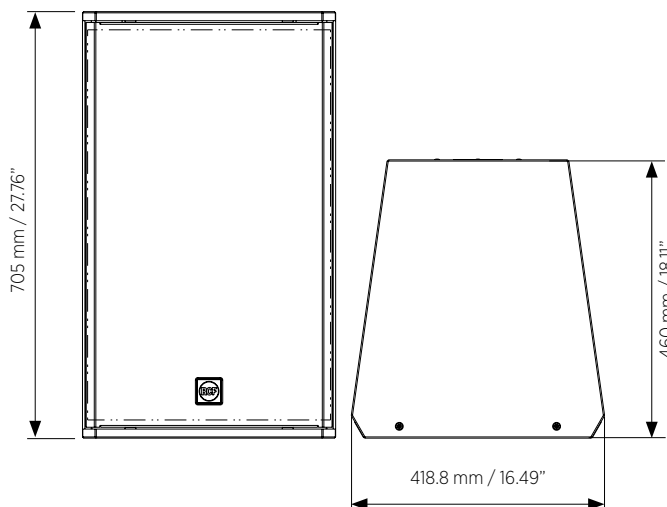

#### RELATED ACCESSORIES

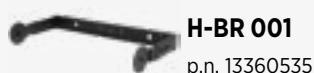

**H-BR 001**

p.n. 13360535

Pair of brackets for COMPACT C 45 cabinets horizontal wall mounting.



**V-BR 001**

p.n. 13360541

Pair of brackets for COMPACT C 45 cabinets vertical wall mounting.



**WM-BR 001**

p.n. 13360538

Bracket for speakers wall mounting. Requires H-BR 001.



**HN-KIT COMPACT C 32 C 45** p.n. 13360505

HN-KIT allows to change COMPACT C 32 speakers' directivity from 100° x 50° to 100° x 25° or 60° x 25°.



**PNL IN-OUT AMPHENOL** p.n. 12399063

PNL IN-OUT AMPHENOL is an optional panel that allows to switch input/output connectors to AMPHENOL IP 67, making them fully weatherproof



## SPECIFICATIONS

### COMPACT C 45

p.n. 13000602

#### Acoustical specifications

Frequency Response (-10dB):	48 Hz ÷ 20000 Hz
Max SPL @ 1m:	138 dB
Horizontal coverage angle:	100°
Vertical coverage angle:	50°
Directivity index Q:	10
System Sensitivity:	98 dB

#### Power section

Amplification:	Full Range
Nominal Impedance:	8 ohm
Power Handling:	700 W RMS
Peak Power Handling:	2800 W PEAK
Recommended Amplifier:	1400 W
Protections:	Dynamic Active Mosfet
Crossover Frequencies:	1100 Hz

#### Transducers

Compression Driver:	1 x 1.4" neo, 4.0" v.c.
Woofer:	15" neo, 4.0" v.c.

#### Input/Output section

Input connectors:	Speakon
Output connectors:	Speakon

#### Standard compliance

Safety agency:	CE compliant
----------------	--------------

#### Physical specifications

Cabinet/Case Material:	Birch plywood
Hardware:	4 x M8, 14 x M10
Grille:	Steel with clothing
Color:	Black - RAL 9005
Dimensions (H x W x D):	27.76" x 16.49" x 18.11"   705 x 418.8 x 460 mm
Weight:	71.65 lbs   32.5 kg

RESPONSE 1W/1m

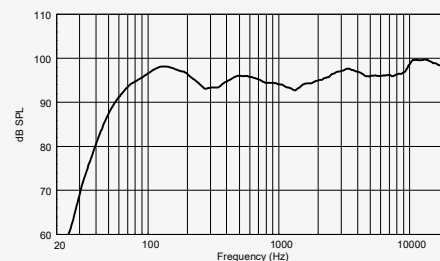

BEAMWIDTH vs. FREQUENCY

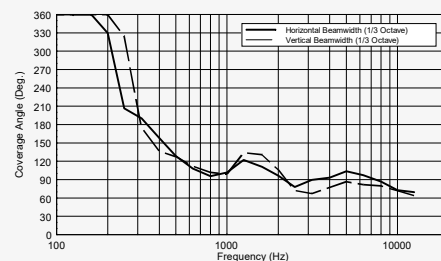

DIRECTIVITY INDEX AND Q

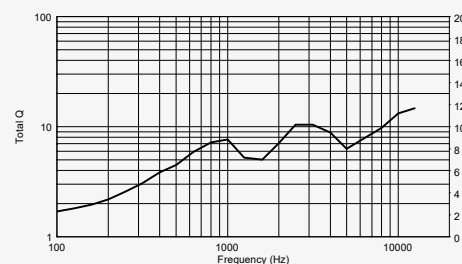

# C32

## C SERIES



### COMPACT C 32

#### TWO-WAY PROFESSIONAL SPEAKER

COMPACT C 32 is a multipurpose two-way point source speaker, suitable for a wide range of near and mid-distance applications. The combination of a 3" neodymium compression driver, a 12" neodymium woofer, and a constant directivity rotatable waveguide produces coherent 100° x 50° coverage for the listening area with high SPL, and distortion-free sound. The sleek and lightweight wood cabinet uses a special polyurea coating and a robust powder-coated grille with protective foam. Optional mounting accessories allow for wall or ceiling installation.

- 600 W power handling (RMS)
- 137 dB max SPL
- 54 ÷ 20000 Hz frequency range
- 100° x 50° constant directivity coverage angle
- 1 x 12" high power neodymium woofer
- 1 x 3.0" v.c. neodymium compression driver
- High quality birch plywood cabinet
- Steel front grille with clothing
- Installation points available on top, bottom, rear and side panels
- SPEAKON in/out connectors

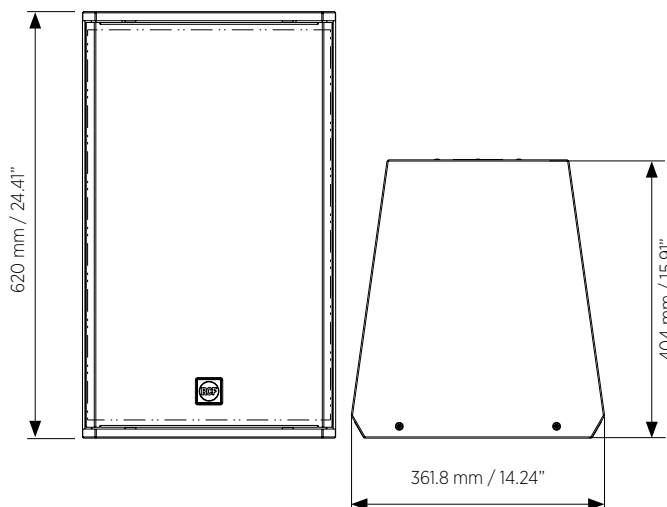

#### RELATED ACCESSORIES



**H-BR 003**  
p.n. 13360538

Pair of brackets for COMPACT C 32 cabinets horizontal wall mounting.



**V-BR 002**  
p.n. 13360533

Pair of brackets for COMPACT C 32 cabinets vertical wall mounting.



**WM-BR 001**  
p.n. 13360538

Bracket for speakers wall mounting. Requires H-BR 003.



**HN-KIT COMPACT C 32 C 45** p.n. 13360505

HN-KIT allows to change COMPACT C 32 speakers' directivity from 100° x 50° to 100° x 25° or 60° x 25°.



**PNL IN-OUT AMPHENOL** p.n. 12399063

PNL IN-OUT AMPHENOL is an optional panel that allows to switch input/output connectors to AMPHENOL IP 67, making them fully weatherproof



## SPECIFICATIONS

### COMPACT C 32

p.n. 13000642

#### Acoustical specifications

Frequency Response (-10dB):	54 Hz ÷ 20000 Hz
Max SPL @ 1m:	137 dB
Horizontal coverage angle:	100°
Vertical coverage angle:	50°
Directivity index Q:	10
System Sensitivity:	97 dB

#### Power section

Amplification:	Full Range
Nominal Impedance:	8 ohm
Power Handling:	600 W RMS
Peak Power Handling:	2400 W PEAK
Recommended Amplifier:	1200 W
Protections:	Dynamic Active Mosfet
Crossover Frequencies:	1100 Hz

#### Transducers

Compression Driver:	1 x 1.4" neo, 3.0" v.c
Woofer:	12" neo, 3.5" v.c

#### Input/Output section

Input connectors:	Speakon
Output connectors:	Speakon

#### Standard compliance

Safety agency:	CE compliant
----------------	--------------

#### Physical specifications

Cabinet/Case Material:	Birch plywood
Hardware:	4 x M8, 14 x M10
Grille:	Steel with clothing
Color:	Black - RAL 9005
Dimensions (H x W x D):	24.41" x 14.24" x 15.91"   620 x 361.8 x 404 mm
Weight:	51.81 lbs   23.5 kg

RESPONSE 1W/1m

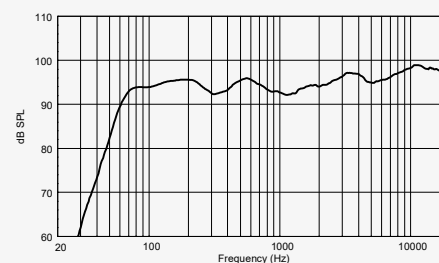

BEAMWIDTH vs. FREQUENCY

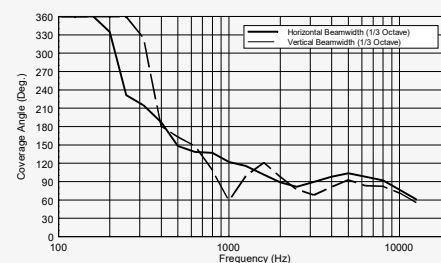

DIRECTIVITY INDEX AND Q

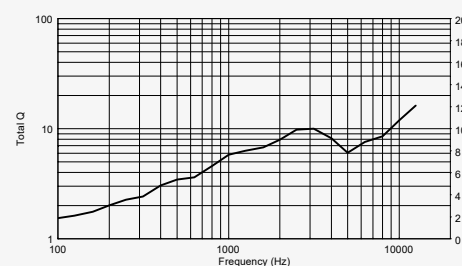

# 3110

## C SERIES



### C 3110-126

#### TWO-WAY PASSIVE SPEAKER

The C3110 is a full range extremely versatile wide-dispersion, low profile, two-way loudspeaker system for near field applications. Its compact size makes it ideal for low visibility side wall mounting. The high-frequency section is a constant directivity horn loaded to a 1" compression driver with a 1.5" diaphragm assembly for smooth, wide dispersion. The low-frequency transducer is a 10" woofer with a 2" voice coil.

Dynamic high-frequency driver protection is accomplished with a new RCF exclusive - 'Active Mosfet Compression Driver Protection System' (AMCDP), chosen to complement the driver power curve.

- 120° x 60° CMD (Coverage Matching Design) constant directivity horn
- Rotatable Horn System for horizontal cabinet mounting applications
- HF driver AMCDP (Active Mosfet Compression Driver Protection)
- LICC (Low Impedance Compensated Crossover) network
- 10 Suspension points
- 1 top pole mount, 1 bottom pole mount

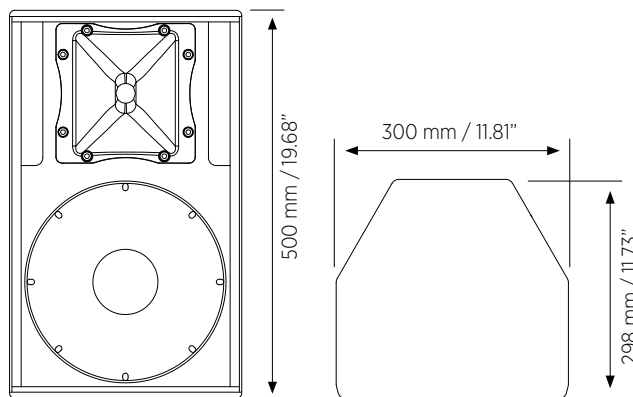

#### RELATED ACCESSORIES



**CL-BR NC**  
p.n. 13360217

Pipe clamp accessory. Adjustable inclination.



**FL-BR NC 06-08-10**  
p.n. 13360200

Flying bracket. Adjustable inclination



**SWM-BR NC**  
p.n. 13360199

Wall mount swivel bracket.



**H-BR 2X NC10**  
p.n. 13360191

Pair of horizontal brackets. Adjustable inclination.



**V-BR 2X NC10**  
p.n. 13360196

Pair of vertical brackets. Adjustable inclination.



**SPECIFICATIONS**

**C 3110-126**

p.n. 13000284

**Acoustical specifications**

Frequency Response (-10dB):	67 Hz ÷ 20000 Hz
Max SPL @ 1m:	128 dB
Horizontal coverage angle:	120°
Vertical coverage angle:	60°
Directivity index Q:	9
System Sensitivity:	97 dB

**Power section**

Amplification:	Full Range
Nominal Impedance:	8 ohm
Power Handling:	300 W
Peak Power Handling:	1200 W PEAK
Recommended Amplifier:	600 W
Protections:	Dynamic active mosfet
Crossover Frequencies:	2200 Hz

**Transducers**

Compression Driver:	1.0", 1.5" v.c
Woofer:	10", 2.0" v.c

**Input/Output section**

Input connectors:	Speakon® NL4
Output connectors:	Speakon® NL4

**Standard compliance**

Safety agency:	CE compliant
----------------	--------------

**Physical specifications**

Cabinet/Case Material:	Baltic birch plywood
Hardware:	8 x M8 (rear), 2 x M10 (lateral), multiplates (top and bottom)
Pole mount/Cap:	Yes
Grille:	Steel with robust double mesh polyester clothing
Color:	Black
Dimensions (H x W x D):	19.69" x 11.81" x 11.73"   500 x 300 x 298 mm
Weight:	34.83 lbs   15.8 kg

RESPONSE 1W/1m

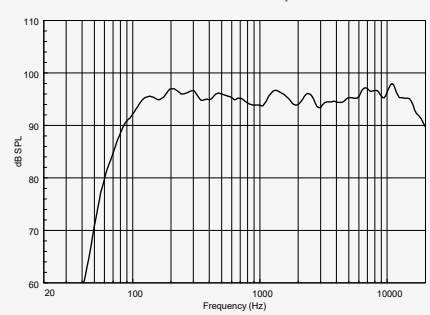

IMPEDANCE

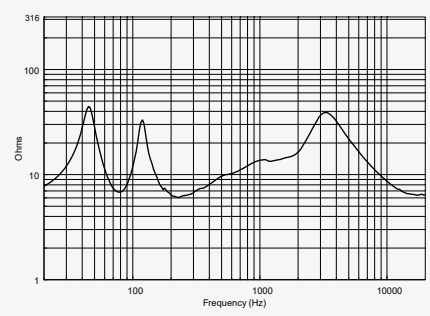

BEAMWIDTH vs. FREQUENCY

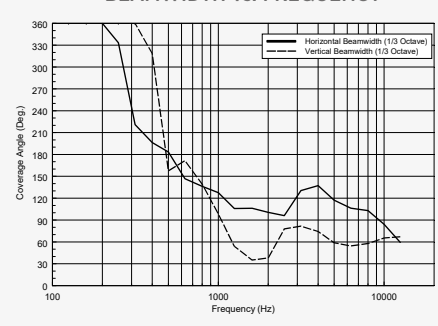

DIRECTIVITY INDEX AND Q

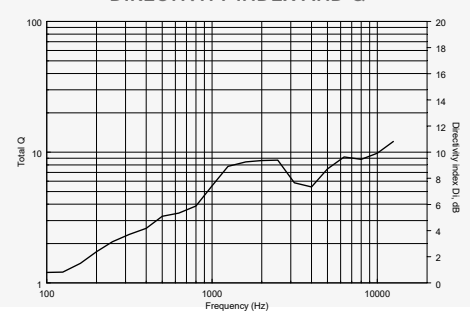

# 3110

## C SERIES



### C 3110-96

#### TWO-WAY PASSIVE SPEAKER

The C3110 is a full range extremely versatile wide-dispersion, low profile, two-way loudspeaker system for near field applications. Its compact size makes it ideal for low visibility side wall mounting. The high-frequency section is a constant directivity horn loaded to a 1" compression driver with a 1.5" diaphragm assembly for smooth, wide dispersion. The low-frequency transducer is a 10" woofer with a 2" voice coil.

RCF exclusive 'Constant Matching Design' technology helps guarantee an optimal transition between the high frequency horn polar pattern and the low frequency woofer directivity. The horn can be rotated, allowing to install the loudspeaker either vertically or horizontally.

- 90° x 60° CMD (Coverage Matching Design) constant directivity horn
- Rotatable Horn System for horizontal cabinet mounting applications
- HF driver AMCDP (Active Mosfet Compression Driver Protection)
- LICC (Low Impedance Compensated Crossover) network
- 10 Suspension points
- 1 top pole mount, 1 bottom pole mount

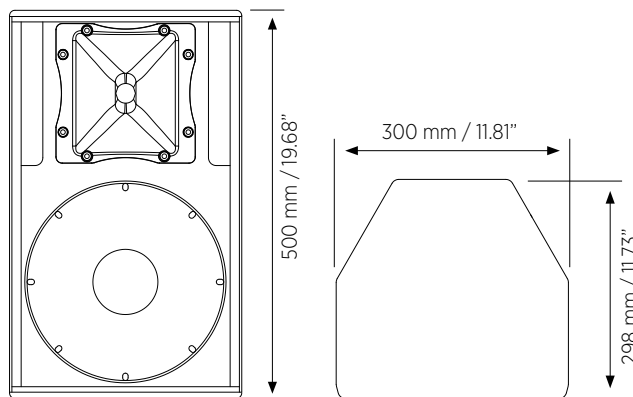

#### RELATED ACCESSORIES



**CL-BR NC**  
p.n. 13360217

Pipe clamp accessory. Adjustable inclination.



**FL-BR NC 06-08-10**  
p.n. 13360200

Flying bracket. Adjustable inclination



**SWM-BR NC**  
p.n. 13360199

Wall mount swivel bracket.



**H-BR 2X NC10**  
p.n. 13360191

Pair of horizontal brackets. Adjustable inclination.



**V-BR 2X NC10**  
p.n. 13360196

Pair of vertical brackets. Adjustable inclination.





## SPECIFICATIONS

### C 3110-96

p.n. 13000283

#### Acoustical specifications

Frequency Response (-10dB):	67 Hz ÷ 20000 Hz
Max SPL @ 1m:	128 dB
Horizontal coverage angle:	90°
Vertical coverage angle:	60°
Directivity index Q:	11
System Sensitivity:	97 dB

#### Power section

Amplification:	Full Range
Nominal Impedance:	8 ohm
Power Handling:	300 W
Peak Power Handling:	1200 W PEAK
Recommended Amplifier:	600 W
Protections:	Dynamic active mosfet
Crossover Frequencies:	2200 Hz

#### Transducers

Compression Driver:	1.0", 1.5" v.c
Woofer:	10", 2.0" v.c

#### Input/Output section

Input connectors:	Speakon® NL4
Output connectors:	Speakon® NL4

#### Standard compliance

Safety agency:	CE compliant
----------------	--------------

#### Physical specifications

Cabinet/Case Material:	Baltic birch plywood
Hardware:	8 x M8 (rear), 2 x M10 (lateral), multiplates (top and bottom)
Pole mount/Cap:	Yes
Grille:	Steel with robust double mesh polyester clothing
Color:	Black
Dimensions (H x W x D):	19.68" x 11.81" x 11.73"   500 x 300 x 298 mm
Weight:	34.83 lbs   15.8 kg

RESPONSE 1W/1m

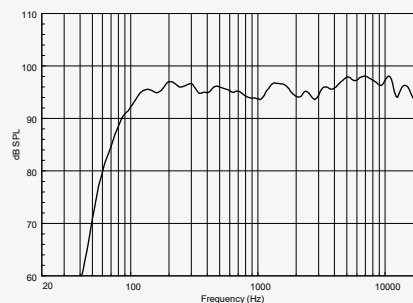

IMPEDANCE

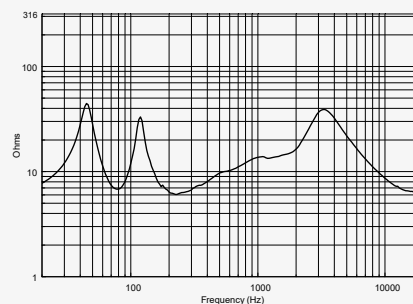

BEAMWIDTH vs. FREQUENCY

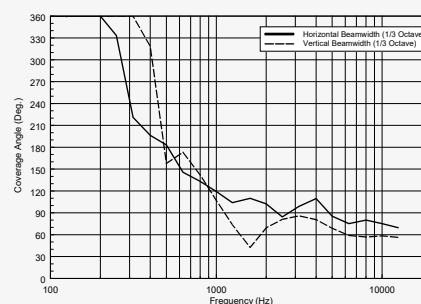

DIRECTIVITY INDEX AND Q

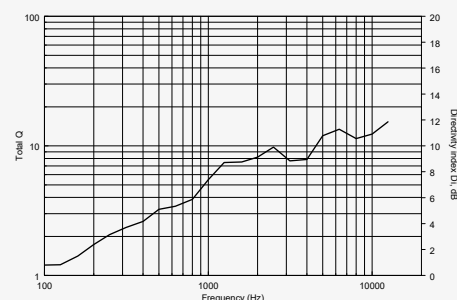

# 3108

## C SERIES



### C 3108-126

#### TWO-WAY PASSIVE SPEAKER

The C3108-126 is a full range extremely versatile wide-dispersion, low profile, two-way loudspeaker system for near field applications. Its compact size makes it ideal for low visibility side wall mounting. The high-frequency section is a constant directivity horn loaded to a 1" compression driver with a 1.5" diaphragm assembly for smooth, wide dispersion. The low-frequency transducer is an 8" woofer with a 2" voice coil.

Dynamic high-frequency driver protection is accomplished with a new RCF exclusive - 'Active Mosfet Compression Driver Protection System' (AMCDP), chosen to complement the driver power curve.

- 120°x 60° CMD (Constant Matching Design) constant directivity horn
- Rotatable Horn System for horizontal cabinet mounting applications
- HF driver AMCDP (Active Mosfet Compression Driver Protection)
- LICC (Low Impedance Compensated Crossover) network
- 8 Suspension points
- Omnimount™ 75 Plate fixing positions on rear of cabinet

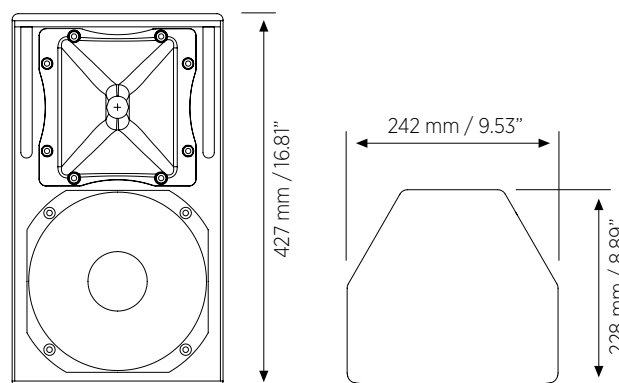

#### RELATED ACCESSORIES



**CL-BR NC**  
p.n. 13360217

Pipe clamp accessory. Adjustable inclination.



**FL-BR NC 06-08-10**  
p.n. 13360200

Flying bracket. Adjustable inclination



**SWM-BR NC**  
p.n. 13360199

Wall mount swivel bracket.



**H-BR 2X NC08**  
p.n. 13360190

Pair of horizontal brackets. Adjustable inclination.



**V-BR 2X NC08**  
p.n. 13360195

Pair of vertical brackets. Adjustable inclination.



## SPECIFICATIONS

### C 3108-126

p.n. 13000282

#### Acoustical specifications

Frequency Response (-10dB):	70 Hz ÷ 20000 Hz
Max SPL @ 1m:	126 dB
Horizontal coverage angle:	120°
Vertical coverage angle:	60°
Directivity index Q:	9
System Sensitivity:	95 dB

#### Power section

Amplification:	Full Range
Nominal Impedance:	8 ohm
Power Handling:	300 W
Peak Power Handling:	1200 W PEAK
Recommended Amplifier:	600 W
Protections:	Dynamic active mosfet
Crossover Frequencies:	2000 Hz

#### Transducers

Compression Driver:	1.0", 1.5" v.c
Woofer:	8", 2.0" v.c

#### Input/Output section

Input connectors:	Speakon® NL4
Output connectors:	Speakon® NL4

#### Standard compliance

Safety agency:	CE compliant
----------------	--------------

#### Physical specifications

Cabinet/Case Material:	Baltic birch plywood
Hardware:	8 x M8 (rear), 2 x M10 (lateral), multiplates (top and bottom)
Pole mount/Cap:	Yes
Grille:	Steel with robust double mesh polyester clothing
Color:	Black
Dimensions (H x W x D):	16.81" x 9.53" x 10.35"   427 x 242 x 263 mm
Weight:	26.46 lbs   12 kg

RESPONSE 1W/1m

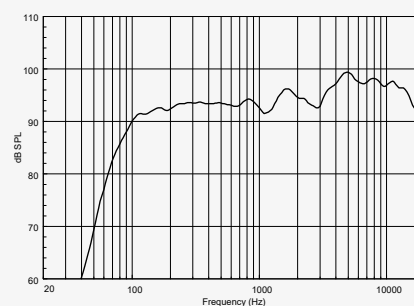

IMPEDANCE

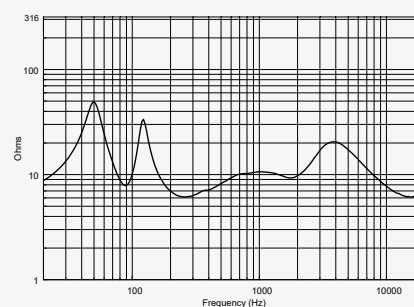

BEAMWIDTH vs. FREQUENCY

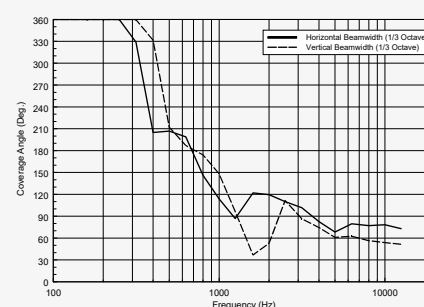

DIRECTIVITY INDEX AND Q

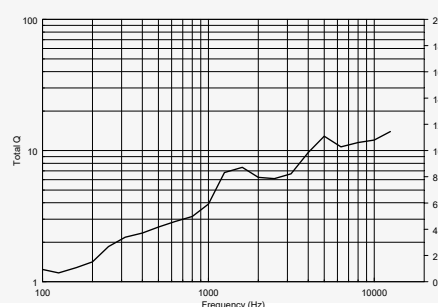

# 3108

## C SERIES



### C 3108-96

#### TWO-WAY PASSIVE SPEAKER

The C3108 is a full range extremely versatile wide-dispersion, low profile, two-way loudspeaker system for near field applications. Its compact size makes it ideal for low visibility side wall mounting. The high-frequency section is a constant directivity horn loaded to a 1" compression driver with a 1.5" diaphragm assembly for smooth, wide dispersion. The low-frequency transducer is an 8" woofer with a 2" voice coil.

Dynamic high-frequency driver protection is accomplished with a new RCF exclusive - 'Active Mosfet Compression Driver Protection System' (AMCDP), chosen to complement the driver power curve.

- 90°x 60° CMD (Constant Matching Design) constant directivity horn
- Rotatable Horn System for horizontal cabinet mounting applications
- HF driver AMCDP (Active Mosfet Compression Driver Protection)
- LICC (Low Impedance Compensated Crossover) network

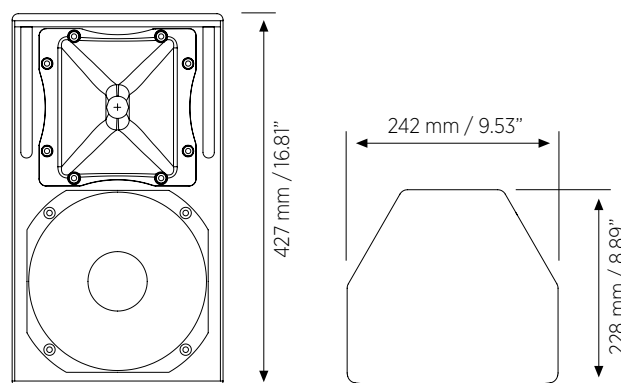

#### RELATED ACCESSORIES



**CL-BR NC**  
p.n. 13360217

Pipe clamp accessory. Adjustable inclination.



**FL-BR NC 06-08-10**  
p.n. 13360200

Flying bracket. Adjustable inclination



**SWM-BR NC**  
p.n. 13360199

Wall mount swivel bracket.



**H-BR 2X NC08**  
p.n. 13360190

Pair of horizontal brackets. Adjustable inclination.



**V-BR 2X NC08**  
p.n. 13360195

Pair of vertical brackets. Adjustable inclination.



## SPECIFICATIONS

### C 3108-96

p.n. 13000281

#### Acoustical specifications

Frequency Response (-10dB):	70 Hz ÷ 20000 Hz
Max SPL @ 1m:	126 dB
Horizontal coverage angle:	90°
Vertical coverage angle:	60°
Directivity index Q:	10
System Sensitivity:	95 dB

#### Power section

Amplification:	Full Range
Nominal Impedance:	8 ohm
Power Handling:	300 W RMS
Peak Power Handling:	1200 W PEAK
Recommended Amplifier:	600 W
Protections:	Dynamic active mosfet
Crossover Frequencies:	2000 Hz

#### Transducers

Compression Driver:	1.0", 1.5" v.c
Woofer:	8", 2.0" v.c

#### Input/Output section

Input connectors:	Speakon® NL4
Output connectors:	Speakon® NL4

#### Standard compliance

Safety agency:	CE compliant
----------------	--------------

#### Physical specifications

Cabinet/Case Material:	Baltic birch plywood
Hardware:	8 x M8 (rear), 2 x M10 (lateral), multiplates (top and bottom)
Pole mount/Cap:	Yes
Grille:	Steel with robust double mesh polyester clothing
Color:	Black
Dimensions (H x W x D):	16.81" x 9.53" x 10.35"   427 x 242 x 263 mm
Weight:	26.9 lbs   12.2 kg

RESPONSE 1W/1m

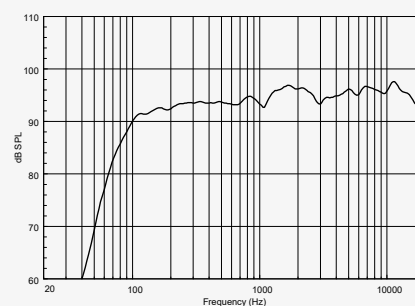

IMPEDANCE

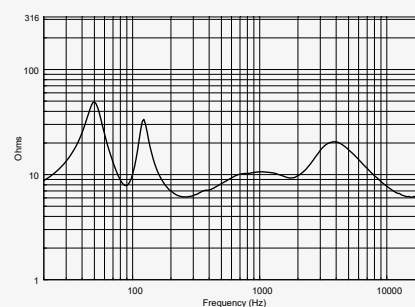

BEAMWIDTH vs. FREQUENCY

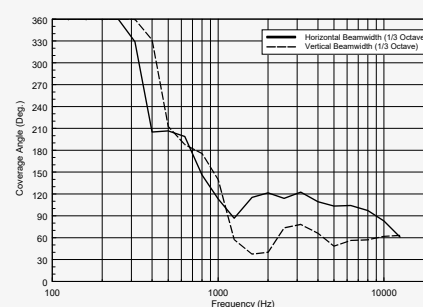

DIRECTIVITY INDEX AND Q

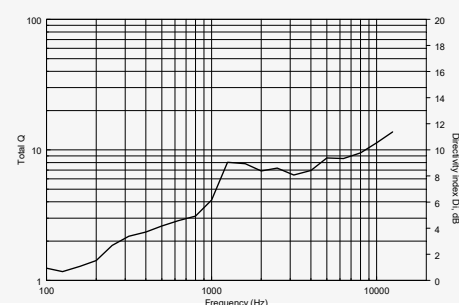

# M 12

## M SERIES

### COMPACT M 12

#### TWO-WAY PASSIVE SPEAKER

COMPACT M 12 is a multipurpose two-way full-range speaker system, suitable for a wide range of applications. Its balanced sound is a big asset in near-field applications for the best intelligibility. The M 12 features high sensitivity, typical of professional audio cabinets thanks to the use of oversized magnets and a HI-FI sound quality, with smooth and wide frequency response, thanks to the wave-guided compression driver. The SPL level of low-distortion audio the M 12 can provide goes far beyond expectations of such a compact solution. The elegant and compact design with accurate finishing makes M 12 suitable for almost any environment, even with architectural constraints. Optional mounting accessories allow using M 12 on wall or ceiling installations.

- 300W AES power handling
- 129 dB max SPL
- 55 ÷ 20000 Hz frequency range
- 90° x 70° constant directivity coverage angle
- 1 x 12" high power woofer
- 1 x 1.4" voice coil compression driver
- High quality plywood cabinet
- Steel front grille with clothing
- Installation points available on rear, side, top and bottom panels
- 4 pole EUROBLOCK connector (audio input and parallel link output)

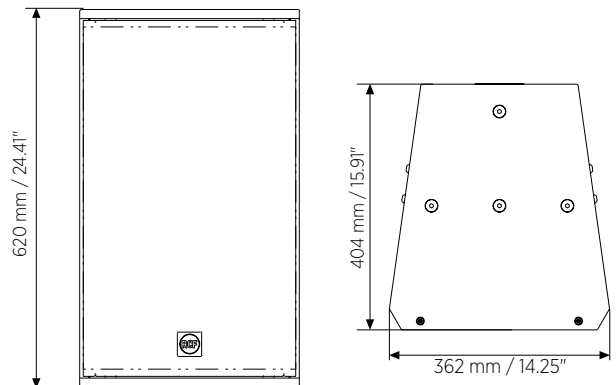

#### RELATED ACCESSORIES



**H-BR 003**  
p.n. 13360538

Pair of brackets for COMPACT M 12 cabinets horizontal wall mounting.



**V-BR 002**  
p.n. 13360533

Pair of brackets for COMPACT M 12 cabinets vertical wall mounting.



**WM-BR 001**  
p.n. 13360538

Bracket for speakers wall mounting. Requires H-BR 003.



**SWM-BR NC**  
13360199

Wall mount swivel bracket.



**PNL IN-OUT AMPHENOL**  
p.n. 12399063

PNL IN-OUT AMPHENOL is an optional panel that allows to switch input/output connectors to AMPHENOL IP 67, making them fully weatherproof



**PNL IN-OUT SPEAKON COMPACT M**  
p.n. 12399062

The EUROBLOCK connection panel can be replaced with female Neutrik SpeakON connection panel in seconds, thanks to the single connector on the back.



## SPECIFICATIONS

### COMPACT M 12

p.n. 13000724 (White) - p.n. 13000596 (Black)

#### Acoustical specifications

Frequency Response (-10dB):	55 Hz ÷ 20000 Hz
Max SPL @ 1m:	129 dB
Horizontal coverage angle:	90°
Vertical coverage angle:	70°
Directivity index Q:	9
System Sensitivity:	98 dB

#### Power section

Amplification:	Full Range
Nominal Impedance:	8 ohm
Power Handling:	300 W
Peak Power Handling:	1200 W PEAK
Recommended Amplifier:	600 W
Protections:	Dynamic active mosfet
Crossover Frequencies:	1800 Hz

#### Transducers

Compression Driver:	1 x 1.0", 1.4" v.c
Woofer:	12", 2.5" v.c

#### Input/Output section

Input connectors:	Euroblock
Output connectors:	Euroblock

#### Standard compliance

Safety agency:	CE compliant
----------------	--------------

#### Physical specifications

Cabinet/Case Material:	Plywood
Hardware:	8 x M8, 8 x M10
Grille:	Steel with clothing
Color:	Black - RAL 9005, White - RAL 9003
Dimensions (H x W x D):	24.41" x 14.25" x 15.91"   620 x 362 x 404 mm
Weight:	48.5 lbs   22 kg

RESPONSE 1W/1m

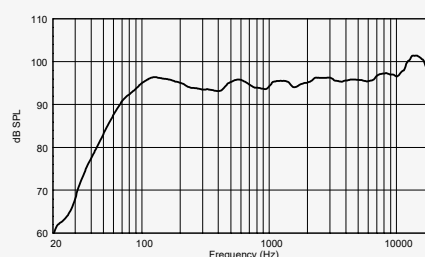

IMPEDANCE

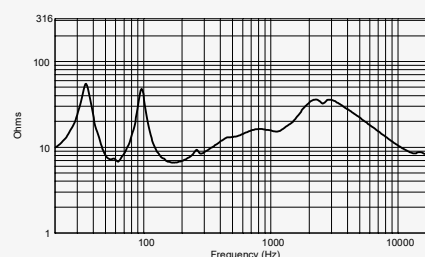

BEAMWIDTH vs. FREQUENCY

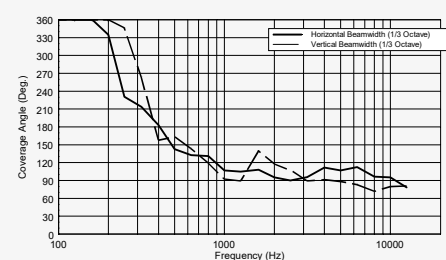

DIRECTIVITY INDEX AND Q

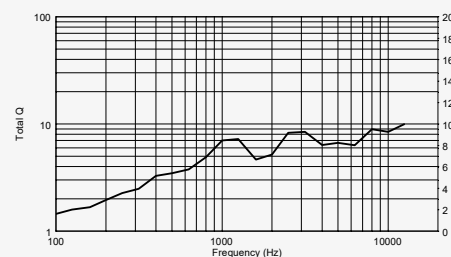

# 10 M SERIES

## COMPACT M 10

### TWO-WAY PASSIVE SPEAKER

COMPACT M 10 is a multipurpose two-way full-range speaker system, suitable for a wide range of applications. Its balanced sound is a big asset in near-field applications for the best intelligibility. The M 10 features high sensitivity, typical of professional audio cabinets thanks to the use of oversized magnets and a HI-FI sound quality, with smooth and wide frequency response, thanks to the wave-guided compression driver. The SPL level of low-distortion audio the M 10 can provide goes far beyond expectations of such a compact solution. The elegant and compact design with accurate finishing makes M 10 suitable for almost any environment, even with architectural constraints. Optional mounting accessories allow using M 10 on wall or ceiling installations.

- 300W AES power handling
- 128 dB max SPL
- 60 ÷ 20000 Hz frequency range
- 90° x 70° constant directivity coverage angle
- 1 x 10" high power woofer
- 1 x 1.4" voice coil compression driver
- High quality plywood cabinet
- Steel front grille with clothing
- Installation points available on rear, side, top and bottom panels
- 4 pole EUROBLOCK connector (audio input and parallel link output)

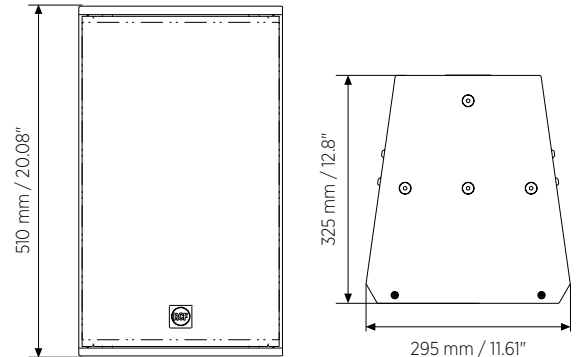

#### RELATED ACCESSORIES



**SWM-BR NC**  
13360199

Wall mount swivel bracket.



**PNL IN-OUT AMPHENOL**  
p.n. 12399063

PNL IN-OUT AMPHENOL is an optional panel that allows to switch input/output connectors to AMPHENOL IP 67, making them fully weatherproof



**PNL IN-OUT SPEAKON COMPACT M**  
p.n. 12399062

The EUROBLOCK connection panel can be replaced with female Neutrik SpeakON connection panel in seconds, thanks to the single connector on the back.



**H-BR 2X COMPACT M 10** p.n. 13360444  
**H-BR 2X COMPACT M 10 W** p.n. 13360463

Pair of horizontal brackets for COMPACT M 10 speakers wall mounting.



**V-BR 2X COMPACT M 10** p.n. 13360447  
**V-BR 2X COMPACT M 10 W** p.n. 13360466

Pair of vertical brackets for COMPACT M 10 speakers wall mounting.





## SPECIFICATIONS

### COMPACT M 10

p.n. 13000723 (White) - p.n. 13000595 (Black)

#### Acoustical specifications

Frequency Response (-10dB):	60 Hz ÷ 20000 Hz
Max SPL @ 1m:	128 dB
Horizontal coverage angle:	90°
Vertical coverage angle:	70°
Directivity index Q:	9
System Sensitivity:	98 dB

#### Power section

Amplification:	Full Range
Nominal Impedance:	8 ohm
Power Handling:	300 W
Peak Power Handling:	1200 W PEAK
Recommended Amplifier:	600 W
Protections:	Dynamic active mosfet
Crossover Frequencies:	1800 Hz

#### Transducers

Compression Driver:	1 x 1.0", 1.4" v.c
Woofer:	10", 2.5" v.c

#### Input/Output section

Input connectors:	Euroblock
Output connectors:	Euroblock

#### Standard compliance

Safety agency:	CE compliant
----------------	--------------

#### Physical specifications

Cabinet/Case Material:	Plywood
Hardware:	8 x M8, 8 x M10
Grille:	Steel with clothing
Color:	Black - RAL 9005, White - RAL 9003
Dimensions (H x W x D):	20.08" x 11.61" x 12.8"   510 x 295 x 325 mm
Weight:	37.48 lbs   17 kg

RESPONSE 1W/1m

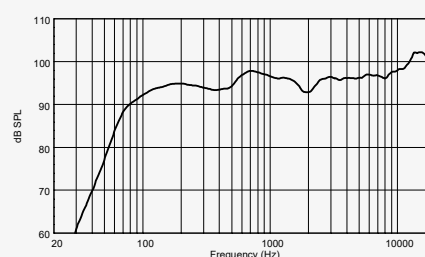

IMPEDANCE

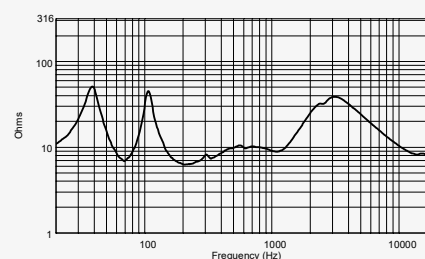

BEAMWIDTH vs. FREQUENCY

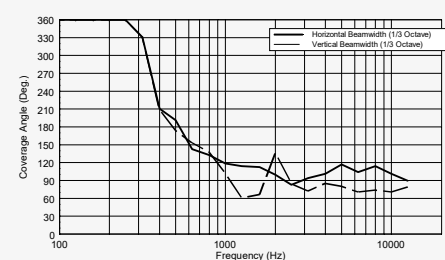

DIRECTIVITY INDEX AND Q

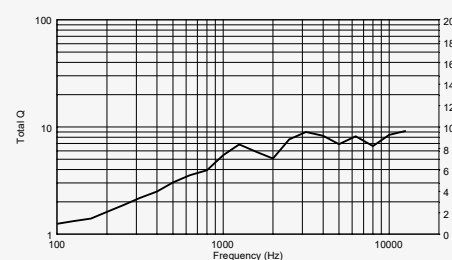

# M SERIES

## COMPACT M 08

### TWO-WAY PASSIVE SPEAKER

COMPACT M 08 is a multipurpose two-way full-range speaker system, suitable for a wide range of applications. Its balanced sound is a big asset in near-field applications for the best intelligibility. The M 08 features high sensitivity, typical of professional audio cabinets thanks to the use of oversized magnets and a HI-FI sound quality, with smooth and wide frequency response, thanks to the wave-guided compression driver. The SPL level of low-distortion audio the M 08 can provide goes far beyond expectations of such a compact solution. The elegant and compact design with accurate finishing makes M 08 suitable for almost any environment, even with architectural constraints. Optional mounting accessories allow using M 08 on wall or ceiling installations.

- 200W AES power handling
- 124 dB max SPL
- 60 ÷ 20000 Hz frequency range
- 90° x 70° constant directivity coverage angle
- 1 x 8" high power woofer
- 1 x 1.4" voice coil compression driver
- High quality plywood cabinet
- Steel front grille with clothing
- Installation points available on rear, side, top and bottom panels
- 4 pole EUROBLOCK connector (audio input and parallel link output)

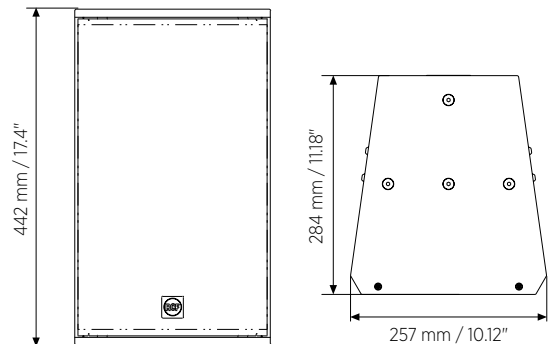

#### RELATED ACCESSORIES



##### PNL IN-OUT SPEAKON COMPACT M

p.n. 12399062

The EUROBLOCK connection panel can be replaced with female Neutrik SpeakON connection panel in seconds, thanks to the single connector on the back.



##### PNL IN-OUT AMPHENOL

p.n. 12399063

PNL IN-OUT AMPHENOL is an optional panel that allows to switch input/output connectors to AMPHENOL IP 67, making them fully weatherproof



##### SWM-BR COMPACT M

p.n. 13360449

##### SWM-BR COMPACT M W

p.n. 13360468

Wall mount bracket.



##### H-BR 2X COMPACT M 08

p.n. 13360443

##### H-BR 2X COMPACT M 08 W

p.n. 13360462

Pair of horizontal brackets for COMPACT M 08 speakers wall mounting.



##### V-BR 2X COMPACT M 08

p.n. 13360446

##### V-BR 2X COMPACT M 08 W

p.n. 13360465

Pair of vertical brackets for COMPACT M 08 speakers wall mounting.



## SPECIFICATIONS

### COMPACT M 08

p.n. 13000722 (White) - p.n. 13000594 (Black)

#### Acoustical specifications

Frequency Response (-10dB):	60 Hz ÷ 20000 Hz
Max SPL @ 1m:	124 dB
Horizontal coverage angle:	90°
Vertical coverage angle:	70°
Directivity index Q:	9
System Sensitivity:	95 dB

#### Power section

Amplification:	Full Range
Nominal Impedance:	8 ohm
Power Handling:	200 W
Peak Power Handling:	800 W PEAK
Recommended Amplifier:	400 W
Protections:	Dynamic active mosfet
Crossover Frequencies:	1800 Hz

#### Transducers

Compression Driver:	1 x 1.0", 1.4" v.c
Woofer:	8", 1.7" v.c

#### Input/Output section

Input connectors:	Euroblock
Output connectors:	Euroblock

#### Standard compliance

Safety agency:	CE compliant
----------------	--------------

#### Physical specifications

Cabinet/Case Material:	Plywood
Hardware:	6 x M6, 4 x M8, 2 x M10
Grille:	Steel with clothing
Color:	Black - RAL 9005, White - RAL 9003
Dimensions (H x W x D):	17.4" x 10.12" x 11.18"   442 x 257 x 284 mm
Weight:	23.15 lbs   10.5 kg

RESPONSE 1W/1m

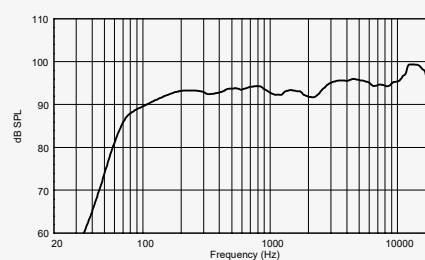

IMPEDANCE

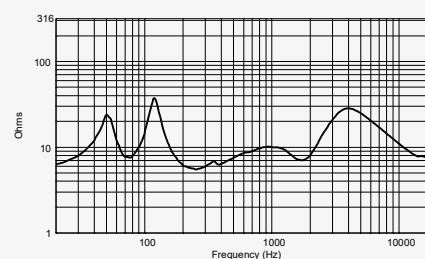

BEAMWIDTH vs. FREQUENCY

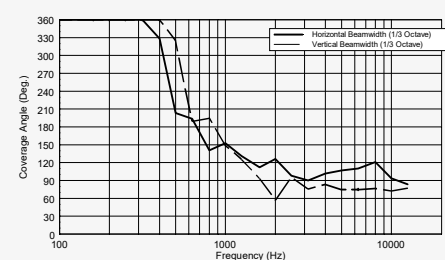

DIRECTIVITY INDEX AND Q

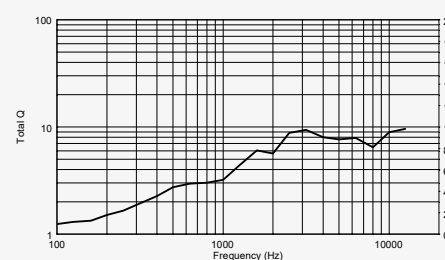

# M SERIES

## COMPACT M 06

### TWO-WAY PASSIVE SPEAKER

COMPACT M 06 is a multipurpose two-way full-range speaker system, suitable for a wide range of applications. Its balanced sound is a big asset in near-field applications for the best intelligibility. The M 06 features high sensitivity, typical of professional audio cabinets thanks to the use of oversized magnets and a HI-FI sound quality, with smooth and wide frequency response, thanks to the wave-guided neodymium dome tweeter. The SPL level of low-distortion audio the M 06 can provide goes far beyond expectations of such a compact solution. The elegant and compact design with accurate finishing makes M 06 suitable for almost any environment, even with architectural constraints. Optional mounting accessories allow using M 06 on wall or ceiling installations

- 100W AES power handling
- 116 dB max SPL
- 60 ÷ 20000 Hz frequency range
- 120° x 80° constant directivity coverage angle
- 1 x 6" high power woofer
- 1 x 1" voice coil neodymium dome tweeter
- High quality plywood cabinet
- Steel front grille with clothing
- Installation points available on rear, top and bottom panels
- 4 pole EUROBLOCK connector (audio input and parallel link output)

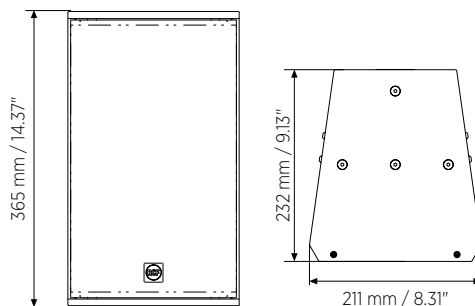

#### RELATED ACCESSORIES



##### PNL IN-OUT SPEAKON COMPACT M

p.n. 12399062

The EUROBLOCK connection panel can be replaced with female Neutrik SpeakON connection panel in seconds, thanks to the single connector on the back.



##### PNL IN-OUT AMPHENOL

p.n. 12399063

PNL IN-OUT AMPHENOL is an optional panel that allows to switch input/output connectors to AMPHENOL IP 67, making them fully weatherproof



##### SWM-BR COMPACT M

p.n. 13360449

##### SWM-BR COMPACT M W

p.n. 13360468

Wall mount bracket.



##### H-BR 2X COMPACT M 06

p.n. 13360461

##### H-BR 2X COMPACT M 06 W

p.n. 13360470

Pair of horizontal brackets for COMPACT M 06 speakers wall mounting.



## SPECIFICATIONS

### COMPACT M 06

p.n. 13000721 (White) - p.n. 13000582 (Black)

#### Acoustical specifications

Frequency Response (-10dB):	60 Hz ÷ 20000 Hz
Max SPL @ 1m:	116 dB
Horizontal coverage angle:	120°
Vertical coverage angle:	80°
Directivity index Q:	7
System Sensitivity:	90 dB

#### Power section

Amplification:	Full Range
Nominal Impedance:	8 ohm
Power Handling:	100 W
Peak Power Handling:	400 W PEAK
Recommended Amplifier:	200 W
Protections:	Dynamic active mosfet
Crossover Frequencies:	2200 Hz

#### Transducers

Compression Driver:	1.3" neo, 1.0" v.c
Woofer:	6.0", 1.5" v.c

#### Input/Output section

Input connectors:	Euroblock
Output connectors:	Euroblock

#### Standard compliance

Safety agency:	CE compliant
----------------	--------------

#### Physical specifications

Cabinet/Case Material:	Plywood
Hardware:	4 x M6, 2 x M8
Grille:	Steel with clothing
Color:	Black - RAL 9005, White - RAL 9003
Dimensions (H x W x D):	14.37" x 8.31" x 9.13"   365 x 211 x 232 mm
Weight:	12.13 lbs   5.5 kg

RESPONSE 1W/1m

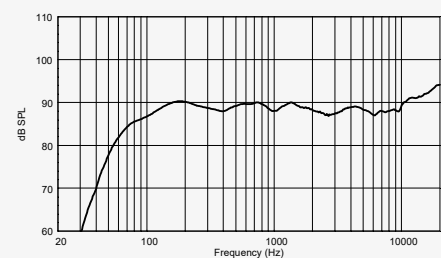

IMPEDANCE

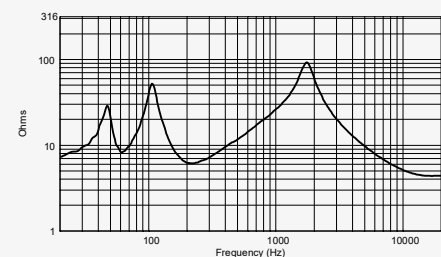

BEAMWIDTH vs. FREQUENCY

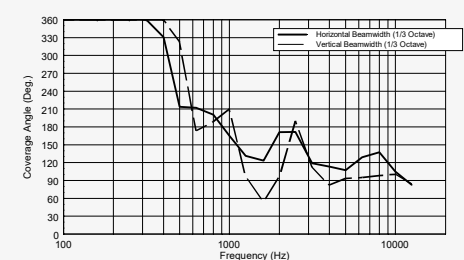

DIRECTIVITY INDEX AND Q

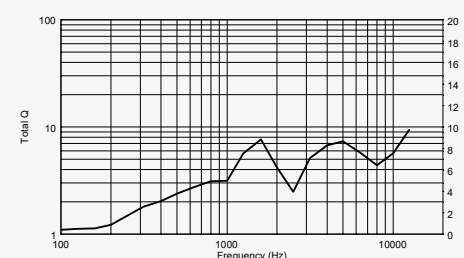

# M 05

## M SERIES

### COMPACT M 05

#### TWO-WAY PASSIVE SPEAKER

COMPACT M 05 is a multipurpose two-way full-range speaker system, suitable for a wide range of applications. Its balanced sound is a big asset in near-field applications for the best intelligibility. M 05 features high sensitivity, typical of professional audio cabinets thanks to the use of oversized magnets and a HI-FI sound quality, with smooth and wide frequency response, thanks to the wave-guided neodymium dome tweeter. The SPL level of low-distortion audio the M 05 can provide goes far beyond expectations of such a compact solution. The elegant and compact design with accurate finishing makes M 05 suitable for almost any environment, even with architectural constraints. Optional mounting accessories allow the use of the M 05 on wall or ceiling installations

- 80W AES power handling
- 115 dB max SPL
- 70 ÷ 20000 Hz frequency range
- 120° x 80° constant directivity coverage angle
- 1 x 5" high power woofer
- 1 x 1" voice coil neodymium dome tweeter
- High quality plywood cabinet
- Steel front grille with clothing
- Installation points available on rear, top and bottom panels
- 4 pole EUROBLOCK connector (audio input and parallel link output)

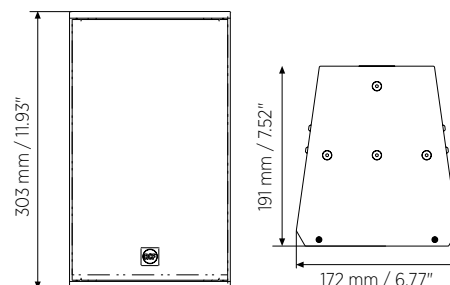

#### RELATED ACCESSORIES



##### PNL IN-OUT SPEAKON COMPACT M

p.n. 12399062

The EUROBLOCK connection panel can be replaced with female Neutrik SpeakON connection panel in seconds, thanks to the single connector on the back.



##### PNL IN-OUT AMPHENOL

p.n. 12399063

PNL IN-OUT AMPHENOL is an optional panel that allows to switch input/output connectors to AMPHENOL IP 67, making them fully weatherproof



##### SWM-BR COMPACT M

p.n. 13360449

##### SWM-BR COMPACT M W

p.n. 13360468

Wall mount bracket.



##### H-BR 2X COMPACT M 05

p.n. 13360460

##### H-BR 2X COMPACT M 05 W

p.n. 13360469

Pair of horizontal brackets for COMPACT M 05 speakers wall mounting.



## SPECIFICATIONS

### COMPACT M 05

p.n. 13000720 (White) - p.n. 13000581 (Black)

#### Acoustical specifications

Frequency Response (-10dB):	70 Hz ÷ 20000 Hz
Max SPL @ 1m:	115 dB
Horizontal coverage angle:	120°
Vertical coverage angle:	80°
Directivity index Q:	7
System Sensitivity:	89 dB

#### Power section

Amplification:	Full Range
Nominal Impedance:	8 ohm
Power Handling:	80 W
Peak Power Handling:	320 W PEAK
Recommended Amplifier:	160 W
Protections:	2200 Hz
Crossover Frequencies:	2200 Hz

#### Transducers

Compression Driver:	1.3" neo, 1.0" v.c
Woofer:	5.0", 1.2" v.c

#### Input/Output section

Input connectors:	Euroblock
Output connectors:	Euroblock

#### Standard compliance

Safety agency:	CE compliant
----------------	--------------

#### Physical specifications

Cabinet/Case Material:	Plywood
Hardware:	4 x M6, 2 x M8
Grille:	Steel with clothing
Color:	Black - RAL 9005, White - RAL 9003
Dimensions (H x W x D):	11.93" x 6.77" x 7.52"   303 x 172 x 191 mm
Weight:	9.26 lbs   4.2 kg

RESPONSE 1W/1m

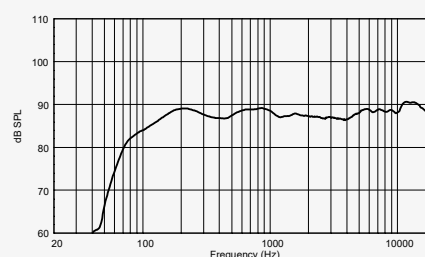

IMPEDANCE

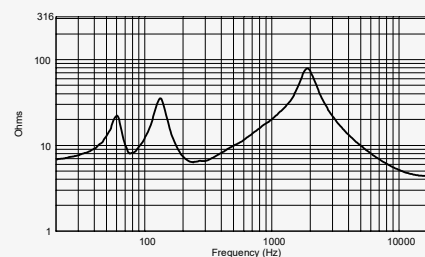

BEAMWIDTH vs. FREQUENCY

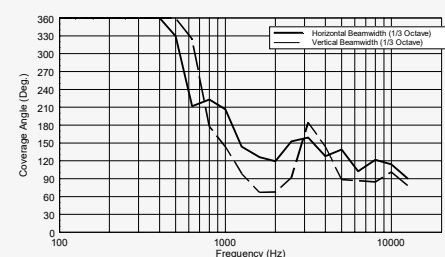

DIRECTIVITY INDEX AND Q

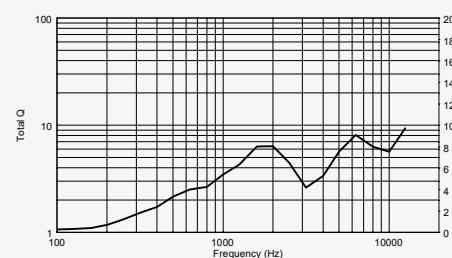

# M 04

## M SERIES

### COMPACT M 04

#### TWO-WAY PASSIVE SPEAKER

COMPACT M 04 is a multipurpose two-way full-range speaker system, suitable for a wide range of applications. The compactness, together with the elegant and neutral design with accurate finishing make M 04 suitable for almost any environment and architectural constraint. Its comfortable sound helps heavily in the near field applications. Included mounting accessory allows using M 04 wall or ceiling mounted, to fit with several applications. The SPL and the level of undistorted sound M 04 can reach are far above any expectation from such a compact solution. M 04 features high sensitivity typical of professional audio cabinets thanks to the use of oversized magnets in coaxial configuration, and an HI-FI sound quality with smooth and wide frequency response performed thanks to the wave-guided neodymium dome tweeter.

- 60W RMS power handling
- 110 dB max SPL
- 90 ÷ 20000 Hz frequency range
- 120° x 120° constant directivity coverage angle
- 1 x 4" high power woofer
- 1 x 1" voice coil neodymium dome tweeter
- High quality plywood cabinet
- U-bracket included
- Steel front grille with clothing
- 4 pole EUROBLOCK connector (audio input and parallel link output)

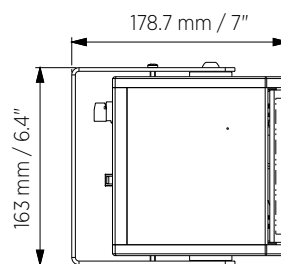
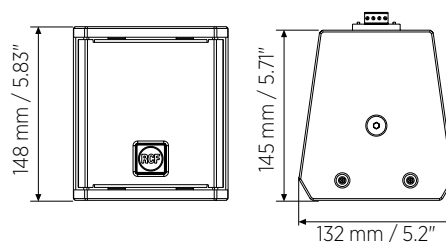

#### U-BRACKET INCLUDED







## SPECIFICATIONS

### COMPACT M 04

p.n. 13000725 (White) - p.n. 13000623 (Black)

#### Acoustical specifications

Frequency Response (-10dB):	90 Hz ÷ 20000 Hz
Max SPL @ 1m:	113 dB
Horizontal coverage angle:	120°
Vertical coverage angle:	120°
Directivity index Q:	6
System Sensitivity:	89 dB

#### Power section

Amplification:	Full Range
Nominal Impedance:	16 ohm
Power Handling:	60 W
Peak Power Handling:	240 W PEAK
Recommended Amplifier:	120 W
Protections:	1800 Hz
Crossover Frequencies:	2200 Hz

#### Transducers

Compression Driver:	1.0" neo, 1.0" v.c
Woofer:	4.0", 1.0" v.c

#### Input/Output section

Input connectors:	Euroblock
Output connectors:	Euroblock

#### Standard compliance

Safety agency:	CE compliant
----------------	--------------

#### Physical specifications

Cabinet/Case Material:	Plywood
Hardware:	2 x M6, 2 x M8
Grille:	Steel with clothing
Color:	Black - RAL 9005, White - RAL 9003
Dimensions (H x W x D):	5.83" x 5.2" x 5.71"   148 x 132 x 145 mm
Weight:	5.7 lbs   2.3 kg

RESPONSE 1W/1m

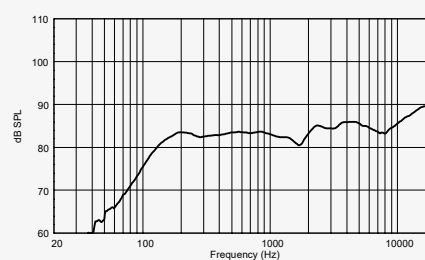

IMPEDANCE

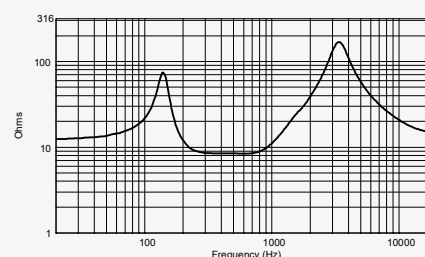

BEAMWIDTH vs. FREQUENCY

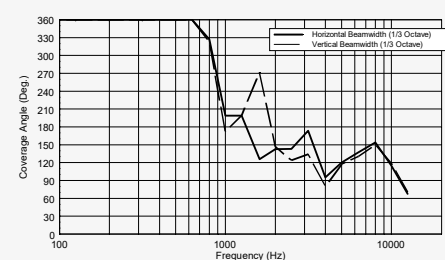

DIRECTIVITY INDEX AND Q

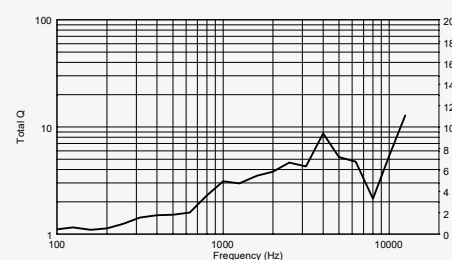

# 15 A SERIES

## COMPACT A 15

### TWO-WAY PROFESSIONAL SPEAKER

COMPACT A 15 is a multipurpose two-way full-range professional speaker system, suitable for a wide range of applications, such as live sound reinforcement and stage monitoring as well as distributed sound systems for clubs or music venues. The combination of a 1.75" compression driver, 15" woofer, and the constant directivity True Resistive Waveguide produces coherent 100° x 60° coverage for the listening area with high SPL, distortion-free sound. The sleek and lightweight cabinet uses a special polypropylene composite material with an M-brace internal reinforcement, making it easy to carry and secure to install on a pole, flown-, wall-, or truss-mounted using the multiple rigging points and available accessories.



- 450 W power handling
- Up to 130 dB Sound Pressure Level
- 50-20000 Hz linear frequency response
- 1.75" Compression Driver
- 15" High Power Woofer
- Robust composite material cabinet
- Steel full front grille
- Optional mounting accessories
- 2 x SPEAKON connectors

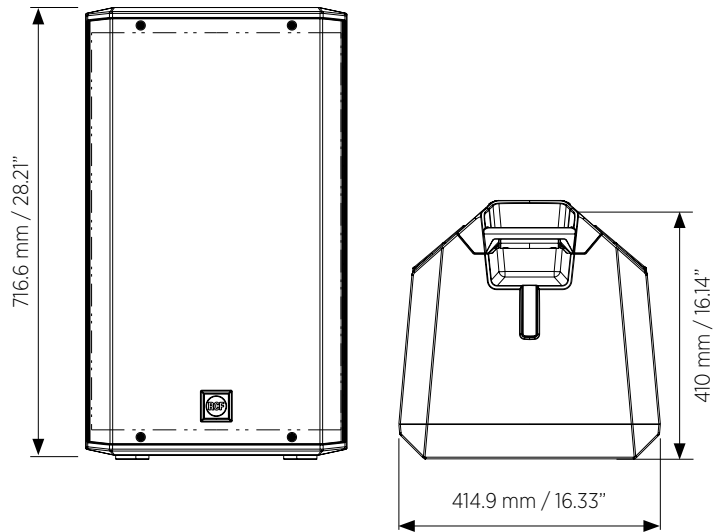

#### RELATED ACCESSORIES



**CVR ART 915** p.n. 13360478  
Padded Cover for COMPACT A 15.



**H-BR ART 915** p.n. 13360479  
H-BR Horizontal Mount Bracket for COMPACT A 15.



**FL-BR ART 915** p.n. 13360481  
FL-BR Flying Mount Bracket for COMPACT A 15.



**V-BR ART 915** p.n. 13360480  
V-BR Vertical Mount Bracket for COMPACT A 15.



**SPECIFICATIONS**

**COMPACT A 15**

p.n. 13000740

**Acoustical specifications**

Frequency Response (-10dB):	50 Hz ÷ 20000 Hz
Max SPL @ 1m:	130 dB
Horizontal coverage angle:	100°
Vertical coverage angle:	60°
System Sensitivity:	98 dB

**Power section**

Amplification:	Full Range
Nominal Impedance:	8 ohm
Power Handling:	450 W
Peak Power Handling:	1800 W PEAK
Recommended Amplifier:	900 W
Protections:	Dynamic Active Mosfet
Crossover Frequencies:	1200 Hz

**Transducers**

Compression Driver:	1.0", 1.75" v.c
Woofer:	15", 3.0" v.c

**Input/Output section**

Input connectors:	Speakon
Output connectors:	Speakon

**Standard compliance**

Safety agency:	CE compliant
----------------	--------------

**Physical specifications**

Cabinet/Case Material:	PP Composite
Hardware:	1 x M10 top, 1 x M10 each side
Handles:	1 top, 1 each side
Pole mount/Cap:	Yes
Grille:	Steel
Color:	Black
Dimensions (H x W x D):	28.21" x 16.33" x 16.14"   716.6 x 414.9 x 410 mm
Weight:	51.81 lbs   23.5 kg

RESPONSE 1W/1m

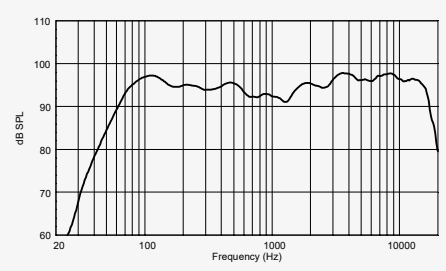

IMPEDANCE

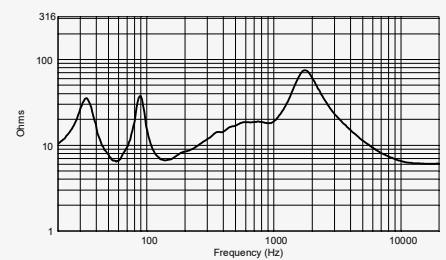

BEAMWIDTH vs. FREQUENCY

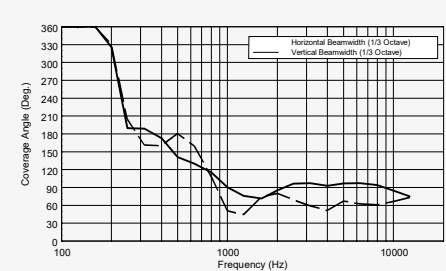

DIRECTIVITY INDEX AND Q

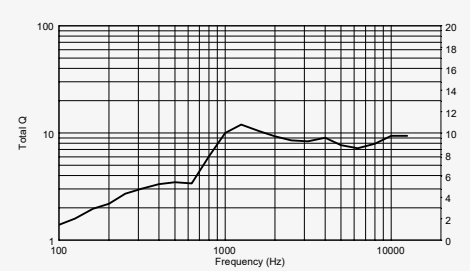

# 12 A SERIES



## COMPACT A 12

### TWO-WAY PROFESSIONAL SPEAKER

COMPACT A 12 is a multipurpose two-way full-range professional speaker system, suitable for a wide range of applications, such as live sound reinforcement and stage monitoring as well as distributed sound systems for clubs or music venues. The combination of a 1.75" compression driver, 12" woofer, and the constant directivity True Resistive Waveguide produces coherent 100° x 60° coverage for the listening area with high SPL, distortion-free sound. The sleek and lightweight cabinet uses a special polypropylene composite material with an M-brace internal reinforcement, making it easy to carry and secure to install on a pole, flown-, wall-, or truss-mounted using the multiple rigging points and available accessories.

- 400 W power handling
- Up to 129 dB Sound Pressure Level
- 55-20000 Hz linear frequency response
- 1.75" Compression Driver
- 12" High Power Woofer
- Robust composite material cabinet
- Steel full front grille
- Optional mounting accessories
- 2 x SPEAKON connectors

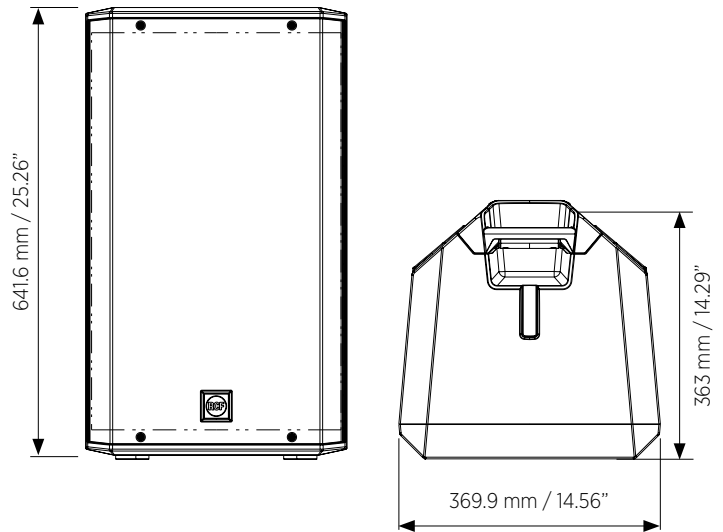

#### RELATED ACCESSORIES



**CVR ART 912** p.n. 13360474  
Padded Cover for COMPACT A 12.



**H-BR ART 912** p.n. 13360475  
H-BR Horizontal Mount Bracket for COMPACT A 12.



**FL-BR ART 915** p.n. 13360477  
FL-BR Flying Mount Bracket for COMPACT A 12.



**V-BR ART 912** p.n. 13360476  
V-BR Vertical Mount Bracket for COMPACT A 12.



**SPECIFICATIONS**

**COMPACT A 12**

p.n. 13000739

**Acoustical specifications**

Frequency Response (-10dB):	55 Hz ÷ 20000 Hz
Max SPL @ 1m:	129 dB
Horizontal coverage angle:	100°
Vertical coverage angle:	60°
System Sensitivity:	97 dB

**Power section**

Amplification:	Full Range
Nominal Impedance:	8 ohm
Power Handling:	400 W
Peak Power Handling:	1600 W PEAK
Recommended Amplifier:	800 W
Protections:	Dynamic Active Mosfet
Crossover Frequencies:	1200 Hz

**Transducers**

Compression Driver:	1.0", 1.75" v.c
Woofer:	12", 2.5" v.c

**Input/Output section**

Input connectors:	Speakon
Output connectors:	Speakon

**Standard compliance**

Safety agency:	CE compliant
----------------	--------------

**Physical specifications**

Cabinet/Case Material:	PP Composite
Hardware:	1 x M10 top, 1 x M10 each side
Handles:	1 top , 1 each side
Pole mount/Cap:	Yes
Grille:	Steel
Color:	Black
Dimensions (H x W x D):	25.26" x 14.56" x 14.29"   641.6 x 369.9 x 363 mm
Weight:	41.45 lbs   18.8 kg

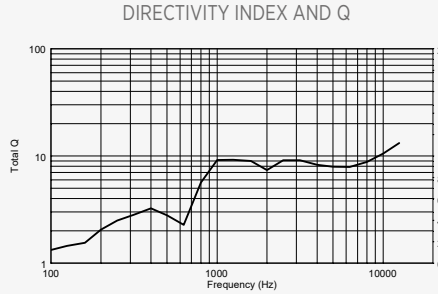
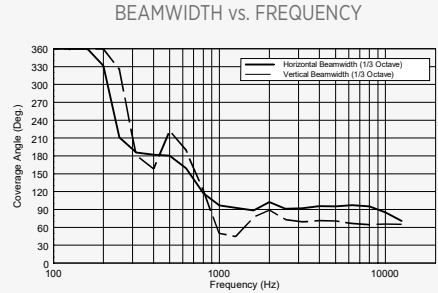
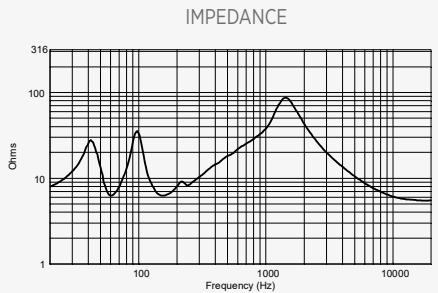
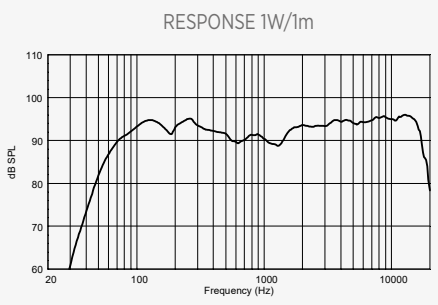

# 10 A SERIES

## COMPACT A 10

### TWO-WAY PROFESSIONAL SPEAKER

COMPACT A 10 is a multipurpose two-way full-range professional speaker system, suitable for a wide range of applications, such as live sound reinforcement and stage monitoring as well as distributed sound systems for clubs or music venues. The combination of a 1.75" compression driver, 10" woofer, and the constant directivity True Resistive Waveguide produces coherent 100° x 60° coverage for the listening area with up to high SPL, distortion-free sound. The sleek and lightweight cabinet uses a special polypropylene composite material with an M-brace internal reinforcement, making it easy to carry and secure to install on a pole, flown-, wall-, or truss-mounted using the multiple rigging points and available accessories.



- 350 W power handling
- Up to 128 dB Sound Pressure Level
- 60-20000 Hz linear frequency response
- 1.75" Compression Driver
- 10" High Power Woofer
- Robust composite material cabinet
- Steel full front grille
- Optional mounting accessories
- 2 x SPEAKON connectors

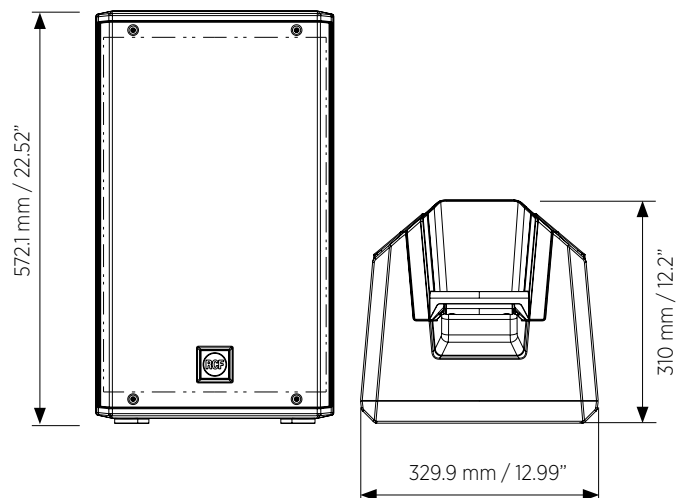

#### RELATED ACCESSORIES



##### CVR ART 910

p.n. 13360473

Padded Cover for COMPACT A 10.



##### H-BR ART 912

p.n. 13360471

H-BR Horizontal Mount Bracket for COMPACT A 10.



##### FL-BR ART 910

p.n. 13360472

FL-BR Flying Mount Bracket for COMPACT A 10.



## SPECIFICATIONS

### COMPACT A 10

p.n. 13000738

#### Acoustical specifications

Frequency Response (-10dB):	60 Hz ÷ 20000 Hz
Max SPL @ 1m:	128 dB
Horizontal coverage angle:	100°
Vertical coverage angle:	60°
System Sensitivity:	97 dB

#### Power section

Amplification:	Full Range
Nominal Impedance:	8 ohm
Power Handling:	350 W
Peak Power Handling:	1400 W PEAK
Recommended Amplifier:	700 W
Protections:	Dynamic Active Mosfet
Crossover Frequencies:	1400 Hz

#### Transducers

Compression Driver:	1.0", 1.75" v.c
Woofer:	10", 2.5" v.c

#### Input/Output section

Input connectors:	Speakon
Output connectors:	Speakon

#### Standard compliance

Safety agency:	CE compliant
----------------	--------------

#### Physical specifications

Cabinet/Case Material:	PP Composite
Hardware:	1 x M10 top and bottom
Handles:	1 top
Pole mount/Cap:	Yes
Grille:	Steel
Color:	Black
Dimensions (H x W x D):	22.52" x 12.99" x 12.2"   572.1 x 329.9 x 310 mm
Weight:	35.71 lbs   16.2 kg

RESPONSE 1W/1m

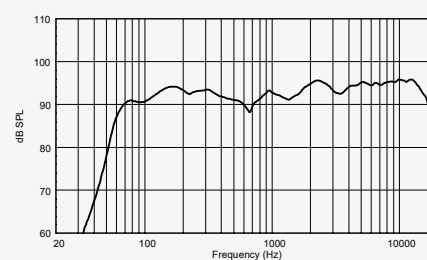

IMPEDANCE

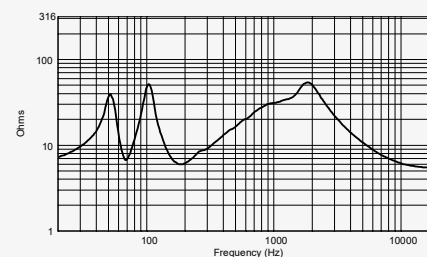

BEAMWIDTH vs. FREQUENCY

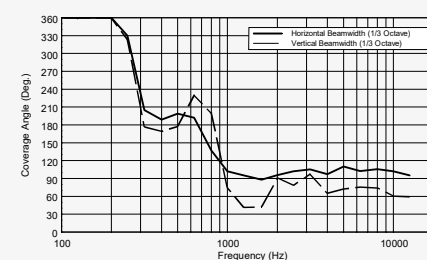

DIRECTIVITY INDEX AND Q

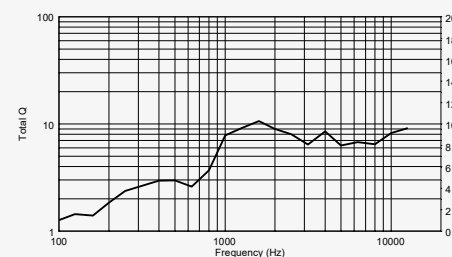

# 12 MAX SERIES

## X-MAX 12

### FULL RANGE HIGH POWER TWO-WAY SPEAKER

X-MAX 12 is a full-range passive two-way speaker designed for entertainment and clubs, featuring high nearfield quality, perfect vocal coherence, and a stable tonal balance even at high volume. The 12" woofer with a 2.5" voice is coupled with a 1.0" compression driver with 1.4" voice coil by a LICC crossover design, which includes electronic protection on the high-frequency device. Black textured acrylic paint protects the plywood heavy-duty speaker cabinet with multiple rigging points. The rotatable 90°x70° horn allows installation either vertically or horizontally for the best versatility in any environment and architectural constraint.



- 800 W program power handling
- 129 dB max SPL
- 60 ÷ 20000 Hz frequency range
- 90° x 70° constant directivity coverage angle
- 1 x 12" high power woofer
- 1 x 1.4" voice coil compression driver
- High quality plywood cabinet
- Installation points available on all sides

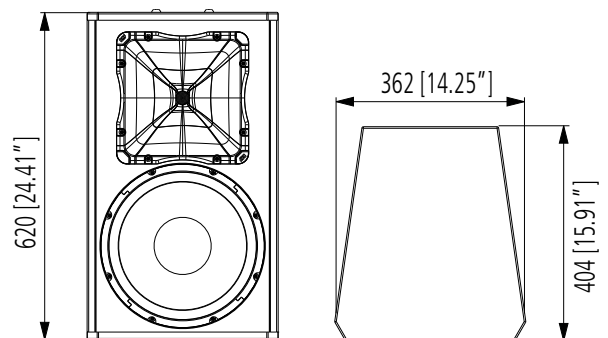

#### ROBUST WORKHORSE

All X-MAX Series cabinets are built-in plywood coated with black textured acrylic paint. A sturdy powder-coated metal grille protects the front, and an acoustically transparent sound foam backing on the inside of the grille ensures protection from dust and humidity.

#### EASY RIGGING

The base of each speaker includes a robust steel pole socket for mounting on a stand or a subwoofer pole. Threaded inserts are provided on all sides for optional mounting hardware. Included are multiple rigging points to fly the speakers for maximum architectural freedom in any installation.





## SPECIFICATIONS

### X-MAX 12

p.n. 13000658

#### Acoustical specifications

Frequency Response (-10dB):	60 Hz ÷ 20000 Hz
Max SPL @ 1m:	129 dB
Horizontal coverage angle:	90°
Vertical coverage angle:	70°
Directivity index Q:	9
System Sensitivity:	97 dB

#### Power section

Amplification:	Full Range
Nominal Impedance:	8 ohm
Power Handling:	400 W
Peak Power Handling:	1600 W PEAK
Recommended Amplifier:	800 W
Protections:	Dynamic active mosfet
Crossover Frequencies:	1800 Hz

#### Transducers

Compression Driver:	1 x 1.0", 1.4" v.c
Woofer:	12", 2.5" v.c

#### Input/Output section

Input connectors:	Speakon
-------------------	---------

#### Standard compliance

Safety agency:	CE compliant
----------------	--------------

#### Physical specifications

Cabinet/Case Material:	Plywood
Hardware:	2 x M8, 16 x M10
Pole mount/Cap:	Yes
Grille:	Steel with clothing
Color:	Black
Dimensions (H x W x D):	24.41" x 14.25" x 15.91"   620 x 362 x 404 mm
Weight:	48.5 lbs   22 kg

RESPONSE 1W/1m

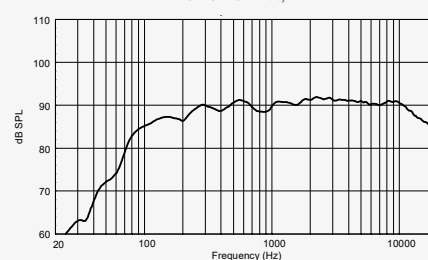

BEAMWIDTH vs. FREQUENCY

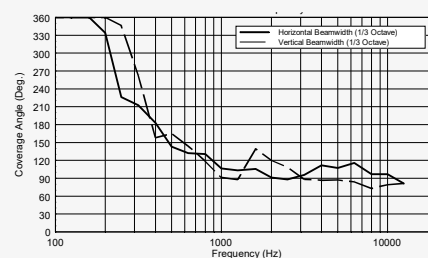

DIRECTIVITY INDEX AND Q

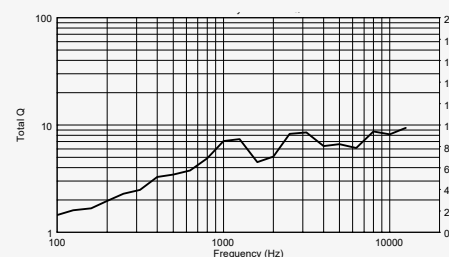

# 10 MAX SERIES

## X-MAX 10

### FULL RANGE HIGH POWER TWO-WAY SPEAKER

X-MAX 10 is a full-range passive two-way speaker designed for entertainment and clubs, featuring high nearfield quality, perfect vocal coherence, and a stable tonal balance even at high volume. The 10" woofer with a 2.5" voice is coupled with a 1.0" compression driver with 1.4" voice coil by a LICC crossover design, which includes electronic protection on the high-frequency device. Black textured acrylic paint protects the plywood heavy-duty speaker cabinet with multiple rigging points. The rotatable 90°x70° horn allows installation either vertically or horizontally for the best versatility in any environment and architectural constraint.



- 700 W program power handling
- 128 dB max SPL
- 65 ÷ 20000 Hz frequency range
- 90° x 70° constant directivity coverage angle
- 1 x 10" high power woofer
- 1 x 1.4" voice coil compression driver
- High quality plywood cabinet
- Installation points available on all panels

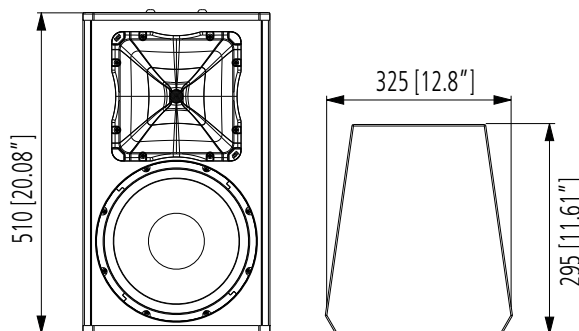

### DESIGNED TO PERFORM

The RCF X-MAX series and its components are designed inside RCF's laboratories and feature superior transducers. Equipped with a rotatable horn with 90° x 70° dispersion pattern, X-MAX 10 boasts a 10" woofer and 1" compression driver, and delivers a maximum SPL of 128 dB SPL over a frequency range of 65 Hz - 20 kHz, with a total power handling of 700 W.

### PERFECTLY TUNED CROSSOVER

The X-MAX Series features a custom-designed mid-freq shaping for close distance listening on a perfectly tuned crossover to ensure the best frequency and phase response. The LICC crossover design includes electronic protection on high-frequency device.



**SPECIFICATIONS**

**X-MAX 10**

p.n. 13000657

**Acoustical specifications**

Frequency Response (-10dB):	65 Hz ÷ 20000 Hz
Max SPL @ 1m:	128 dB
Horizontal coverage angle:	90°
Vertical coverage angle:	70°
Directivity index Q:	11
System Sensitivity:	97 dB

**Power section**

Amplification:	Full Range
Nominal Impedance:	8 ohm
Power Handling:	350 W
Peak Power Handling:	1400 W PEAK
Recommended Amplifier:	700 W
Protections:	Dynamic active mosfet
Crossover Frequencies:	1800 Hz

**Transducers**

Compression Driver:	1 x 1.0", 1.4" v.c
Woofers:	10", 2.5" v.c

**Input/Output section**

Input connectors:	Speakon
-------------------	---------

**Standard compliance**

Safety agency:	CE compliant
----------------	--------------

**Physical specifications**

Cabinet/Case Material:	Plywood
Hardware:	2 x M8, 16 x M10
Grille:	Steel with clothing
Color:	Black
Dimensions (H x W x D):	20.08" x 11.61" x 12.08"   510 x 295 x 325 mm
Weight:	37.48 lbs   17 kg

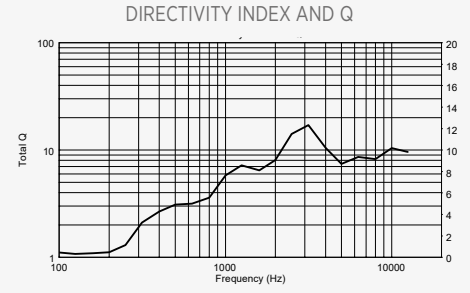
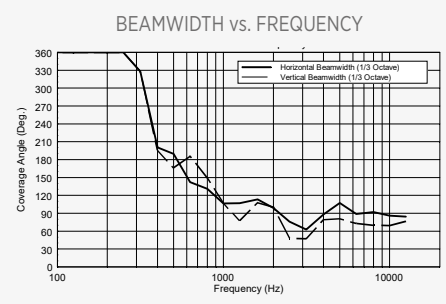
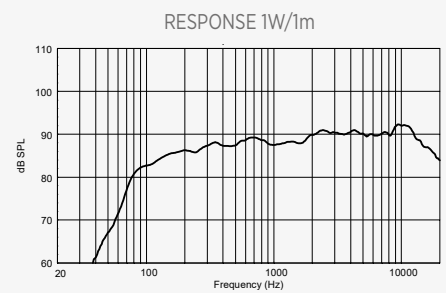

# 4112 MAX SERIES

## C-MAX 4112

### FULL RANGE HIGH POWER NEARFIELD SPEAKER

The full-range passive two-way speaker RCF C-MAX 4112 has been specifically designed as club systems for entertainment, to reach the best near field quality, vocal coherence, and a stable sound pressure level even at high volumes. It features a 12" woofer and a 1" compression driver. The passive C-MAX Series speakers represent a further step of the famous COMPACT Series. Thanks to the bass reflex port, perfectly tuned on the back of the cabinet, the system gives its best when installed near walls, without the need of a subwoofer. It's perfect for KTV, Karaoke rooms, conference halls, AV installations, public areas and clubs.

A strong powder-coated metal grille protects the front, and a transparent to sound foam backing on the inside of the grille ensures protection from dust and humidity. Small isolating rubber elements placed between the cabinet's edges and the grille avoid unwanted vibration.



- 400 W AES power rating
- 60 ÷ 20000 Hz Frequency Range
- 90° x 70° Coverage
- 130 dB SPL Max
- Custom designed mid-freq (2-4 kHz) shaping for close distance listening
- Heavy-duty birch plywood coated with black textured epoxy
- Genuine CUSTOM RCF precision Transducer
- Unique minimum phase filter

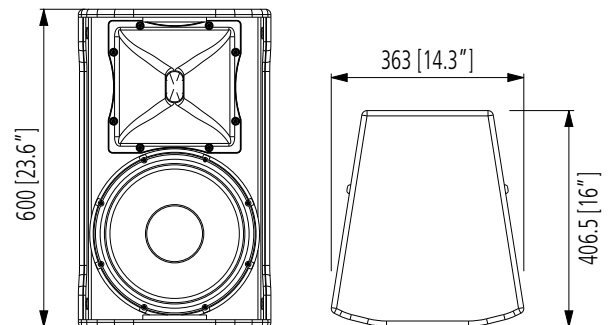

### LOW FREQUENCY TRANSDUCER

The high power 12" woofer is designed to provide an excellent frequency response linearity with very low distortion. A strong magnetic structure guarantee dynamic and precision.

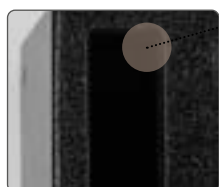

#### BA EX

Rear bass reflex allows a broader extension of low frequencies when the speakers are close to a wall.

### HI FREQUENCY TRANSDUCERS

The RCF ND340 is an extremely compact 1.75" compression driver with 1.0" voice coil for professional applications. Flexible and easy to crossover, it offers high efficiency combined with a very high frequency extension.



#### FLYING POINTS

Thirteen M10 flying points – 9 on the corners and 4 on the sides.



## SPECIFICATIONS

### C-MAX 4112

p.n. 13000535

#### Acoustical specifications

Frequency Response (-10dB):	60 Hz ÷ 20000 Hz
Max SPL @ 1m:	130 dB
Horizontal coverage angle:	90°
Vertical coverage angle:	70°
Directivity index Q:	11
System Sensitivity:	98 dB

#### Power section

Amplification:	Full Range
Nominal Impedance:	8 ohm
Power Handling:	400 W
Peak Power Handling:	1600 W PEAK
Recommended Amplifier:	800 W
Protections:	Bulb lamp
Crossover Frequencies:	1800 Hz

#### Transducers

Compression Driver:	1 x 1.0" neo, 1.75" v.c
Woofer:	12", 3.0" v.c

#### Input/Output section

Input connectors:	Speakon® NL4
Output connectors:	Speakon® NL4

#### Standard compliance

Safety agency:	CE compliant
----------------	--------------

#### Physical specifications

Cabinet/Case Material:	Baltic birch plywood
Hardware:	16 x M10
Handles:	1 Top
Pole mount/Cap:	Yes
Grille:	Steel
Color:	Black
Dimensions (H x W x D):	23.6" x 14.3" x 16"   600 x 363 x 406.5 mm
Weight:	54 lbs   24.5 kg

RESPONSE 1W/1m

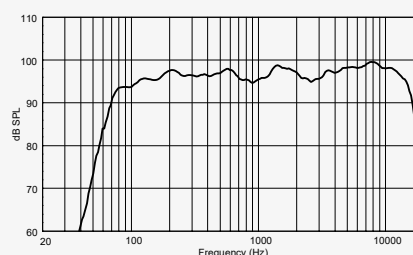

BEAMWIDTH vs. FREQUENCY

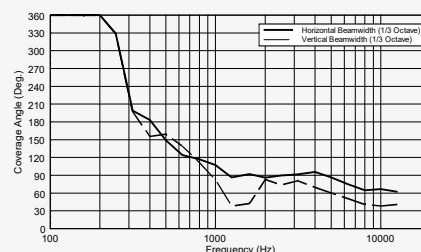

DIRECTIVITY INDEX AND Q

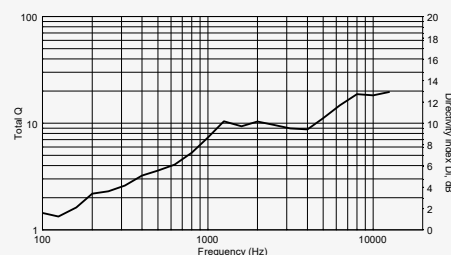

# 4110

## MAX SERIES



### C-MAX 4110

#### FULL RANGE HIGH POWER NEARFIELD SPEAKER

The full-range passive two-way speaker RCF C-MAX 4110 has been specifically designed as club systems for entertainment, to reach the best near field quality, vocal coherence, and a stable sound pressure level even at high volumes. It features a 10" woofer and a 1" compression driver. The passive C-MAX Series speakers represent a further step of the famous COMPACT Series. Thanks to the bass reflex port, perfectly tuned on the back of the cabinet, the system gives its best when installed near walls, without the need of a subwoofer. It's perfect for KTV, Karaoke rooms, conference halls, AV installations, public areas and clubs.

A strong powder-coated metal grille protects the front, and a transparent to sound foam backing on the inside of the grille ensures protection from dust and humidity. Small isolating rubber elements placed between the cabinet's edges and the grille avoid unwanted vibration.

- 350 W AES power rating
- 65 ÷ 20000 Hz Frequency Range
- 90° x 70° Coverage
- 128 dB SPL Max
- Custom designed mid-freq (2-4 kHz) shaping for close distance listening
- Heavy-duty birch plywood coated with black textured epoxy
- Genuine CUSTOM RCF precision Transducer
- Unique minimum phase filter

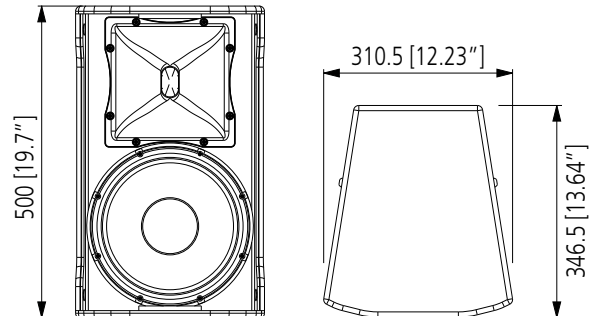

#### LOW FREQUENCY TRANSDUCER

The high power 10" woofer is designed to provide an excellent frequency response linearity with very low distortion. A strong magnetic structure guarantee dynamic and precision.

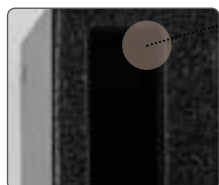

#### BA EX

Rear bass reflex allows a broader extension of low frequencies when the speakers are close to a wall.

#### HI FREQUENCY TRANSDUCERS

The RCF ND340 is an extremely compact 1.75" compression driver with 1.0" voice coil for professional applications. Flexible and easy to crossover, it offers high efficiency combined with a very high frequency extension.



#### FLYING POINTS

Thirteen M10 flying points – 9 on the corners and 4 on the sides.



## SPECIFICATIONS

### C-MAX 4110

p.n. 13000534

#### Acoustical specifications

Frequency Response (-10dB):	65 Hz ÷ 20000 Hz
Max SPL @ 1m:	128 dB
Horizontal coverage angle:	90°
Vertical coverage angle:	70°
Directivity index Q:	11
System Sensitivity:	97 dB

#### Power section

Amplification:	Full Range
Nominal Impedance:	8 ohm
Power Handling:	350 W
Peak Power Handling:	1400 W PEAK
Recommended Amplifier:	700 W
Protections:	Bulb lamp
Crossover Frequencies:	1800 Hz

#### Transducers

Compression Driver:	1 x 1.0" neo, 1.75" v.c
Woofer:	10", 2.5" v.c

#### Input/Output section

Input connectors:	Speakon® NL4
Output connectors:	Speakon® NL4

#### Standard compliance

Safety agency:	CE compliant
----------------	--------------

#### Physical specifications

Cabinet/Case Material:	Baltic birch plywood
Hardware:	16 x M10
Handles:	1 Top
Grille:	Steel
Color:	Black
Dimensions (H x W x D):	19.69" x 12.17" x 13.78"   500 x 309 x 350 mm
Weight:	34.17 lbs   15.5 kg

RESPONSE 1W/1m

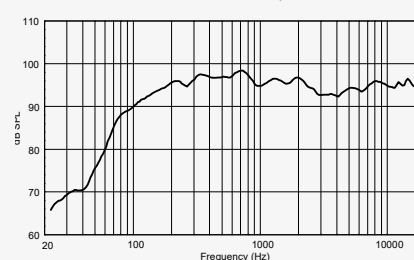

BEAMWIDTH vs. FREQUENCY

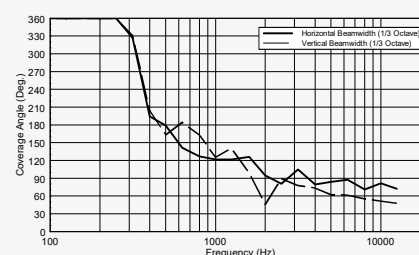

DIRECTIVITY INDEX AND Q

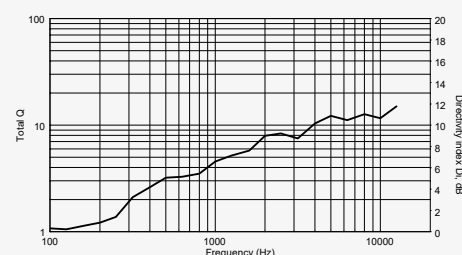

# 3112 MAX SERIES

## E-MAX 3112 MKII

### HIGH POWER TWO-WAY SPEAKER

The full-range passive two-way RCF E-MAX series has been specifically designed as club systems for entertainment, to achieve the best nearfield quality, vocal coherence and a stable tonal balance even at high volume. The heavy-duty speaker cabinet is made of plywood coated with black polyurea paint. Featuring a 12" woofer with a 2.5" voice and a 1.0" compression driver with 1.4" voice coil. The LICC crossover design includes an electronic protection on high-frequency device. The rotatable 90°x70° horn allows installation of the loudspeaker either vertically or horizontally in any environment and architectural constraint.



- 129 dB SPL Max
- 700 W program power handling
- 55 ÷ 20000 Hz Frequency Range
- Plywood coated with black polyurea paint
- 1" Compression Driver
- 12" Woofer Hi Resolution Transducers
- Perfectly Tuned Crossover

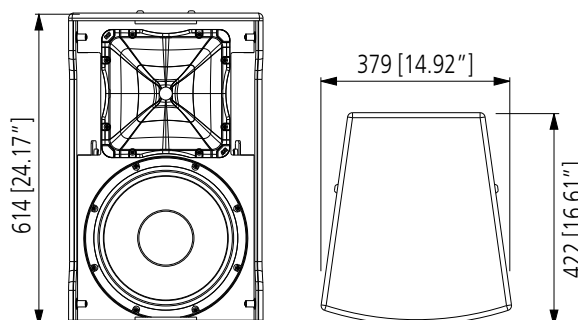

#### CABINET & MECHANICS

All E-MAX Series cabinets are built in heavy-duty birch plywood coated with black textured epoxy. A sturdy black metal grille protects the front, and an acoustically transparent sound foam backing on the inside of the grille ensures protection from dust and humidity. The base of each speaker includes a robust steel pole socket for mounting on a stand or a subwoofer pole. Included are rigging points to fly the speakers for maximum architectural freedom on any installation. Threaded inserts are provided for optional mounting hardware in Installed Sound Applications.

#### HI FREQUENCY TRANSDUCERS

The 1.0" compression driver with 1.4" voice coil provides accurate and coherent response even at very high frequencies. The horn is rotatable, allowing speaker installation both vertically or horizontally.

#### PERFECTLY TUNED CROSSOVER

The E-MAX Series features a custom designed mid-freq shaping for close distance listening on a perfectly tuned crossover to ensure the best frequency and phase response. The LICC crossover design includes electronic protection on high-frequency device.

#### LOW FREQUENCY TRANSDUCER

The high power 12" woofer with a 2.5" voice coil is designed to provide excellent frequency response linearity with very low distortion.





## SPECIFICATIONS

### E-MAX 3112 MKII

p.n. 13000763

#### Acoustical specifications

Frequency Response (-10dB):	55 Hz ÷ 20000 Hz
Max SPL @ 1m:	129 dB
Horizontal coverage angle:	90°
Vertical coverage angle:	70°
Directivity index Q:	11
System Sensitivity:	98 dB

#### Power section

Amplification:	Full Range
Nominal Impedance:	8 ohm
Power Handling:	350 W
Peak Power Handling:	1400 W PEAK
Recommended Amplifier:	700 W
Protections:	Active mosfet
Crossover Frequencies:	1800 Hz

#### Transducers

Compression Driver:	1 x 1.0" neo, 1.5" v.c
Woofer:	12", 2.5" v.c

#### Input/Output section

Input connectors:	Speakon
Output connectors:	Speakon

#### Standard compliance

Safety agency:	CE compliant
----------------	--------------

#### Physical specifications

Cabinet/Case Material:	Plywood
Hardware:	17 x M10, 2 x M8
Handles:	1 Top
Pole mount/Cap:	Yes
Grille:	Steel
Color:	Black
Dimensions (H x W x D):	24.17" x 15" x 16.61"   614 x 381 x 422 mm
Weight:	48.50 lbs   22 kg

RESPONSE 1W/1m

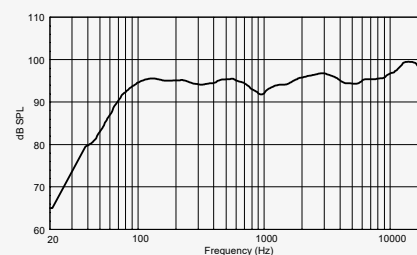

BEAMWIDTH vs. FREQUENCY

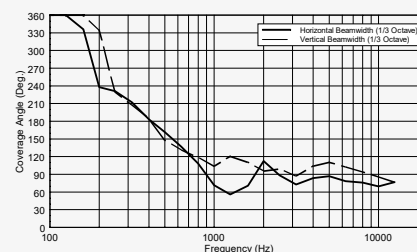

DIRECTIVITY INDEX AND Q

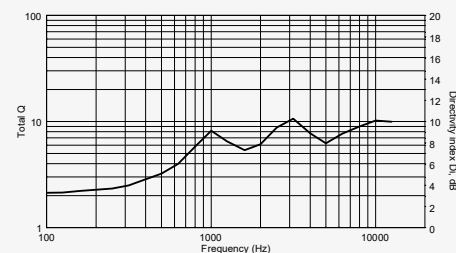

# 3110 MAX SERIES



## E-MAX 3110 MKII

### HIGH POWER TWO-WAY SPEAKER

The full-range passive two-way RCF E-MAX series has been specifically designed as club systems for entertainment, to achieve the best nearfield quality, vocal coherence and a stable tonal balance even at high volume. The heavy-duty speaker cabinet is made of plywood coated with black polyurea paint. Featuring a 10" woofer with a 2.5" voice and a 1.0" compression driver with 1.4" voice coil. The LICC crossover design includes an electronic protection on high-frequency device. The rotatable 90°x70° horn allows installation of the loudspeaker either vertically or horizontally in any environment and architectural constraint.

- 128 dB SPL Max
- 600 W program power handling
- 60 ÷ 20000 Hz Frequency Range
- Plywood coated with black polyurea paint
- 1" Compression Driver, 10"
- Woofer Hi Resolution Transducers
- Perfectly Tuned Crossover

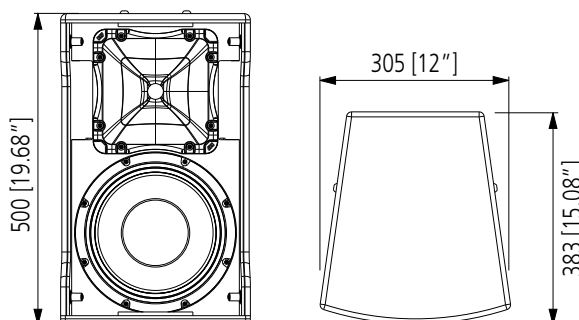

### CABINET & MECHANICS

All E-MAX Series cabinets are built in heavy-duty birch plywood coated with black textured epoxy. A sturdy black metal grille protects the front, and an acoustically transparent sound foam backing on the inside of the grille ensures protection from dust and humidity. The base of each speaker includes a robust steel pole socket for mounting on a stand or a subwoofer pole. Included are rigging points to fly the speakers for maximum architectural freedom on any installation. Threaded inserts are provided for optional mounting hardware in Installed Sound Applications.

### HI FREQUENCY TRANSDUCERS

The 1.0" compression driver with 1.4" voice coil provides accurate and coherent response even at very high frequencies. The horn is rotatable, allowing speaker installation both vertically or horizontally.

### PERFECTLY TUNED CROSSOVER

The E-MAX Series features a custom designed mid-freq shaping for close distance listening on a perfectly tuned crossover to ensure the best frequency and phase response. The LICC crossover design includes electronic protection on high-frequency device.

### LOW FREQUENCY TRANSDUCER

The high power 10" woofer with a 2.5" voice coil is designed to provide excellent frequency response linearity with very low distortion.



## SPECIFICATIONS

### E-MAX 3110 MKII

p.n. 13000762

#### Acoustical specifications

Frequency Response (-10dB):	60 Hz ÷ 20000 Hz
Max SPL @ 1m:	128 dB
Horizontal coverage angle:	90°
Vertical coverage angle:	70°
Directivity index Q:	11
System Sensitivity:	98 dB

#### Power section

Amplification:	Full Range
Nominal Impedance:	8 ohm
Power Handling:	300 W
Peak Power Handling:	1200 W PEAK
Recommended Amplifier:	600 W
Protections:	Active mosfet
Crossover Frequencies:	1800 Hz

#### Transducers

Compression Driver:	1 x 1.0" neo, 1.5" v.c
Woofer:	10", 2.5" v.c

#### Input/Output section

Input connectors:	Speakon
Output connectors:	Speakon

#### Standard compliance

Safety agency:	CE compliant
----------------	--------------

#### Physical specifications

Cabinet/Case Material:	Plywood
Hardware:	17 x M10, 2 x M8
Handles:	1 Top
Pole mount/Cap:	Yes
Grille:	Steel
Color:	Black
Dimensions (H x W x D):	19.69" x 12.01" x 13.31"   500 x 305 x 338 mm
Weight:	35.63 lbs   16.16 kg

RESPONSE 1W/1m

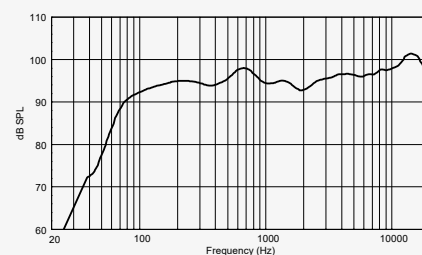

BEAMWIDTH vs. FREQUENCY

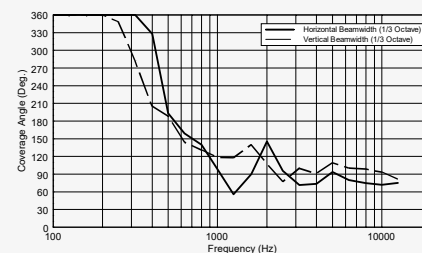

DIRECTIVITY INDEX AND Q

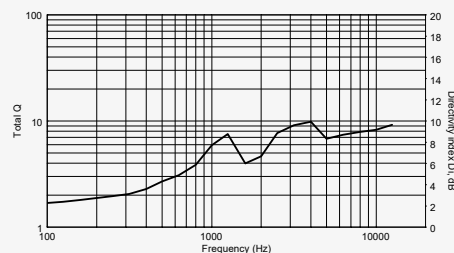

# 5228

## P SERIES

### P 5228-L

#### OUTDOOR/INDOOR TWO-WAY SPEAKER SYSTEM

The P 5228-L is a weatherproof full range, two-way speaker, suitable for a variety of professional applications. The speaker can be installed individually or coupled in array configurations. The high-frequency section includes two constant directivity CMD horns, each loaded with a 1" RCF Precision neodymium compression driver with a 1.75" diaphragm assembly for smooth, highly controlled 20° vertical coverage. The low-frequency section combines two 8" woofers with a 2.5" voice coil. The symmetrical arrangement of the transducers delivers a controlled horizontal dispersion with consistent directivity. Internal circuitry provides LICC crossover and Active Mosfet Compression Driver Protection (AMCDP). The single-piece roto-molded cabinet is fully UV protected and meets IP 55 standard requirements, equipped with M8 brass inserts (4x) and a corrosion-resistant 316P stainless steel U-bracket. Connections to the amplifier are made through a watertight multi-pole connector. The front aluminum grille is powder coated with water-repellent backing material and has a rotatable logo plate.



- 131 dB Max SPL, 500W RMS
- Weatherproof IP55 cabinet with UV protection
- Rotomoulded single piece cabinet
- 90° x 20° constant directivity horn
- 2 x 8" woofer with 2.5" voice coil
- 2 x 1.75" voice coil RCF Precision neodymium compression drivers
- Built-in LICC crossover with AMCDP protection
- Amphenol IP67 4 pole input connector

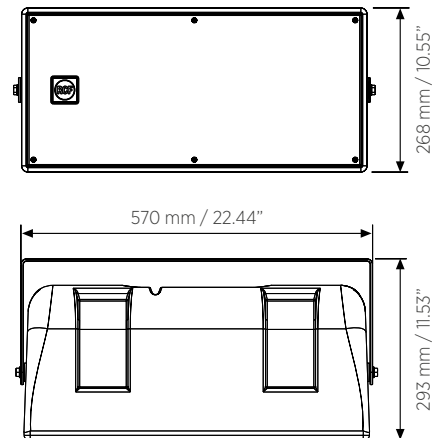

#### RELATED ACCESSORIES



#### C-BR 2X P28

p.n. 13360119

Cluster brackets for P 5228-L  
(including 4 brackets to cluster 2  
speakers)





## SPECIFICATIONS

### P 5228-L

p.n. 13000202

#### Acoustical specifications

Frequency Response (-10dB):	80 Hz ÷ 20000 Hz
Max SPL @ 1m:	131 dB
Horizontal coverage angle:	90°
Vertical coverage angle:	20°
Directivity index Q:	11
System Sensitivity:	98 dB

#### Power section

Amplification:	Full Range
Nominal Impedance:	8 ohm
Power Handling:	500 W
Peak Power Handling:	2000 W PEAK
Recommended Amplifier:	1000 W
Protections:	Dynamic active mosfet
Crossover Frequencies:	1300 Hz

#### Transducers

Compression Driver:	2 x 1.0" neo, 1.75" v.c
Woofer:	2 x 8" neo, 2.5" v.c

#### Input/Output section

Input connectors:	Amphenol eco/mat IP 67
-------------------	------------------------

#### Standard compliance

IP protection grade:	IP 55
Safety agency:	CE compliant

#### Physical specifications

Cabinet/Case Material:	PE Low Density
Hardware:	4 x M8 inserts
Grille:	Aluminum with waterproof clothing
Color:	Grey
Dimensions (H x W x D):	10.55" x 22.28" x 9.84"   268 x 566 x 250 mm
Weight:	30.86 lb   14 kg

RESPONSE 1W/1m

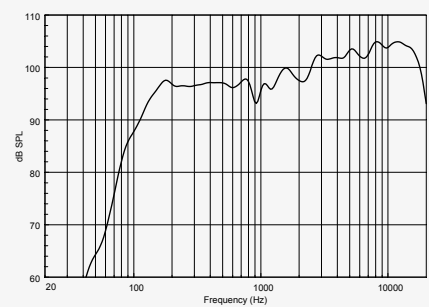

IMPEDANCE

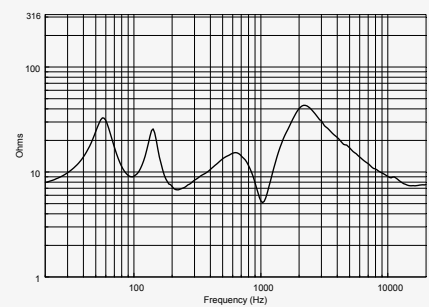

BEAMWIDTH vs. FREQUENCY

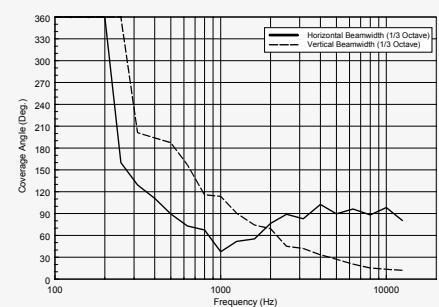

DIRECTIVITY INDEX AND Q

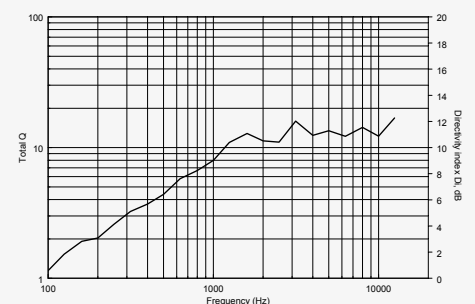

# 4228

## P SERIES

### P 4228

#### WEATHERPROOF TWO-WAY SPEAKER

The P 4228 is a weatherproof full range, two-way speaker, suitable for a variety of professional indoor or outdoor applications. The speaker can be installed individually or coupled in array configurations. The high-frequency section includes two constant directivity CMD horns, each loaded with a 1.4" RCF Precision neodymium compression driver with a 2.5" diaphragm assembly for smooth, highly controlled coverage. The low-frequency section combines two 8" woofers with a 2.5" voice coil. The symmetrical arrangement of the transducers delivers a controlled horizontal dispersion. Internal circuitry provides LICC crossover and Active Mosfet Compression Driver Protection (AMCDP). The single-piece roto-molded cabinet is fully UV protected and meets IP 55 standard requirements, equipped with M8 brass inserts (4x) and one corrosion-resistant 316P stainless steel U-bracket. Connections to the amplifier are made through a watertight multi-pole connector. The aluminum grille cover is powder coated with water-repellent backing material and has a rotatable logo plate.

- 129 dB Max SPL, 400W RMS
- Weatherproof cabinet IP55 with UV protection
- Rotomoulded cabinet available in white or black
- 110° x 60° constant directivity horn
- Built-in passive LICC crossover with AMCDP protection
- 2 x 8" woofer with 2.5" voice coil
- 1 x 2.5" voice coil RCF Precision neodymium compression driver
- Amphenol IP67 4 pole input connector

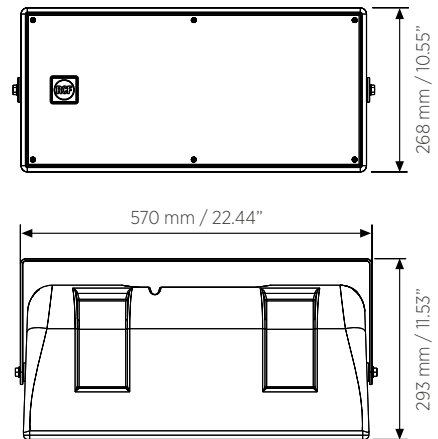

#### RELATED ACCESSORIES



#### C-BR 2X P28

p.n. 13360119

Cluster brackets for P 5228-L  
(including 4 brackets to cluster 2  
speakers)





## SPECIFICATIONS

### P 4228

p.n. 13000199 Grey  
 p.n. 13100081 White  
 p.n. 13100104 Black

#### Acoustical specifications

Frequency Response (-10dB):	80 Hz ÷ 20000 Hz
Max SPL @ 1m:	129 dB
Horizontal coverage angle:	110°
Vertical coverage angle:	60°
Directivity index Q:	9
System Sensitivity:	97 dB

#### Power section

Amplification:	Full Range
Nominal Impedance:	8 ohm
Power Handling:	400 W
Peak Power Handling:	1600 W PEAK
Recommended Amplifier:	800 W
Protections:	Dynamic active mosfet
Crossover Frequencies:	1100 Hz

#### Transducers

Compression Driver:	1 x 1.4" neo, 2.5" v.c
Woofer:	2 x 8", 2.5" v.c

#### Input/Output section

Input connectors:	Amphenol eco/mat IP 67
-------------------	------------------------

#### Standard compliance

Safety agency:	CE compliant
----------------	--------------

#### Physical specifications

Cabinet/Case Material:	PE Low Density
Hardware:	4 x M8 + U-bracket and pair of spacers
Grille:	Aluminum with waterproof clothing
Color:	Grey, White - RAL 9003
Dimensions (H x W x D):	10.55" x 22.28" x 9.84"   268 x 566 x 250 mm
Weight:	30.86 lb   14 kg

RESPONSE 1W/1m

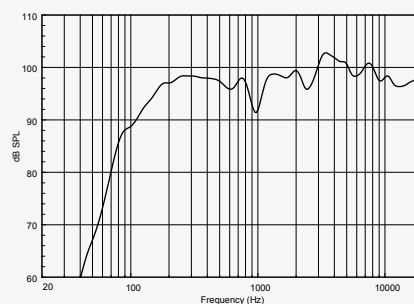

IMPEDANCE

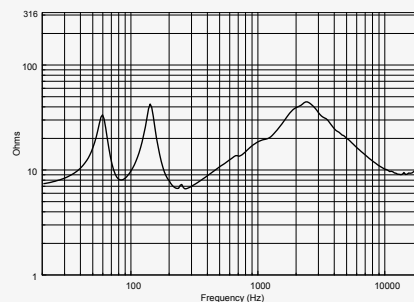

BEAMWIDTH vs. FREQUENCY

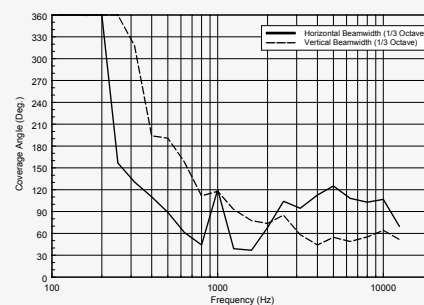

DIRECTIVITY INDEX AND Q

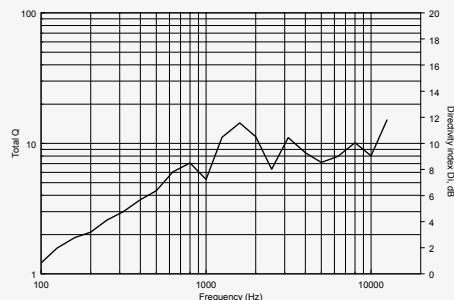

# 3108

## P SERIES

### P 3108

#### WEATHERPROOF TWO WAY LINE ARRAY

The P 3108 is a weatherproof full range, two-way speaker, suitable for a variety of professional indoor or outdoor applications. The speaker can be installed individually or coupled in array configurations. The high-frequency section includes two constant directivity CMD horns, each loaded with a 1" RCF Precision neodymium compression driver, and a 1.5" diaphragm assembly. The low-frequency section combines two 8" woofers with a 2.5" voice coil. The symmetrical arrangement of the transducers delivers a controlled horizontal dispersion. Internal circuitry provides LICC crossover and Active Mosfet Compression Driver Protection (AMCDP). The single-piece roto-molded cabinet is fully UV protected and meets IP 55 standard requirements, equipped with M8 (4x) brass inserts and one corrosion-resistant 316P stainless steel U-bracket. Connections to the amplifier are made through a watertight multi-pole connector. The front aluminum grille cover is powder coated with a water-repellent backing material, with a rotatable logo plate.



- 125 dB Max SPL, 300W RMS
- Weatherproof IP55 cabinet with UV protection
- Rotomoulded single piece cabinet
- 90° x 60° constant directivity horn
- 1 x 8" woofer with 2.5" voice coil
- 1 x 1.5" voice coil RCF Precision compression driver
- Built-in LICC crossover with AMCDP protection
- Amphenol IP67 4 pole input connector

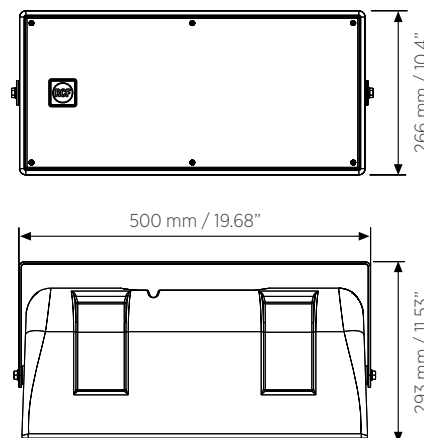

#### RELATED ACCESSORIES

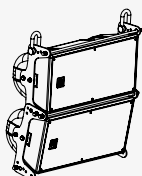

#### AC P08 A-BR

p.n. 13360118

Cluster brackets for P 3108 and P 1108T (including 4 brackets to cluster 2 speakers)







## SPECIFICATIONS

### P 3108

p.n. 13000198

#### Acoustical specifications

Frequency Response (-10dB):	80 Hz ÷ 20000 Hz
Max SPL @ 1m:	125 dB
Horizontal coverage angle:	90°
Vertical coverage angle:	60°
Directivity index Q:	11
System Sensitivity:	94 dB

#### Power section

Amplification:	Full Range
Nominal Impedance:	8 ohm
Power Handling:	300 W
Peak Power Handling:	1200 W PEAK
Recommended Amplifier:	600 W
Protections:	Dynamic active mosfet
Crossover Frequencies:	1800 Hz

#### Transducers

Compression Driver:	1 x 1.0", 1.5" v.c
Woofer:	8", 2.5" v.c

#### Input/Output section

Input connectors:	Amphenol eco/mat IP 67
-------------------	------------------------

#### Standard compliance

IP protection grade:	IP 55
Safety agency:	CE compliant

#### Physical specifications

Cabinet/Case Material:	PE Low Density
Hardware:	4 x M8 + U-bracket and pair of spacers
Grille:	Aluminum with waterproof clothing
Color:	Grey
Dimensions (H x W x D):	10.47" x 19.41" x 9.84"   266 x 493 x 250 mm
Weight:	23.37 lb   10.6 kg

RESPONSE 1W/1m

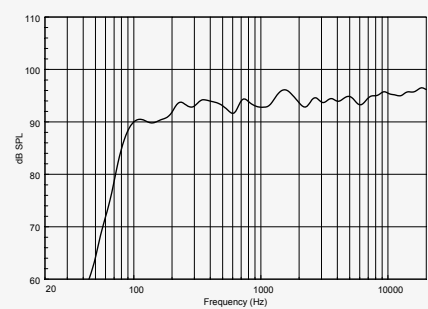

IMPEDANCE

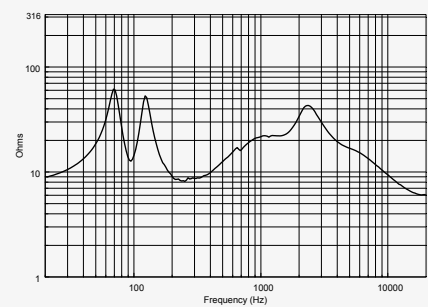

BEAMWIDTH vs. FREQUENCY

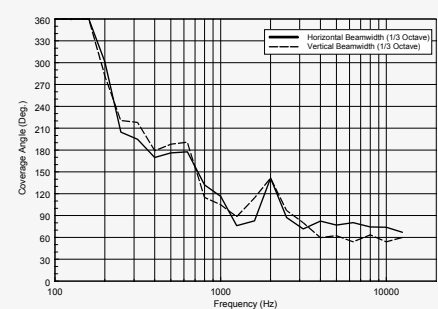

DIRECTIVITY INDEX AND Q

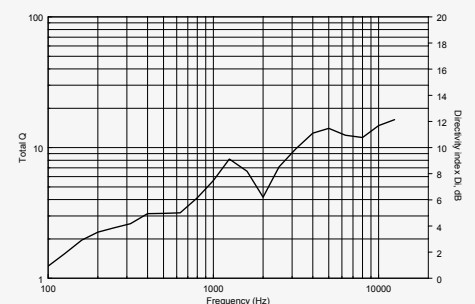

# 1108

## P SERIES

### P 1108T

#### OUTDOOR/INDOOR TWO-WAY SPEAKER SYSTEM

The P 1108T is a weatherproof full range, two-way speaker, suitable for a variety of professional indoor or outdoor applications. The high-frequency section includes a constant directivity CMD horn-loaded enclosure with a 1.4" voice coil RCF Precision neodymium compression driver for smooth, highly-controlled coverage. The low-frequency section features a 8" woofer with a 1.5" voice coil. The P 1108T also features a selectable line transformer for 100 V applications, with built-in LICC crossover, and Active Mosfet Compression Driver Protection (AMCDP). The single-piece rotomolded cabinet is fully UV protected and is equipped with M8 (4x) brass inserts and one electroplated steel U-bracket. The aluminum grille cover is powder coated with a water-repellent backing material, and a rotatable logo plate. The P 1108T meets IP 55 standard requirements (International Protection Rating).



- 121 dB Max SPL, 100W RMS
- Weatherproof cabinet IP 55 with UV protection
- 100 V line transformer
- 90° x 60° constant directivity horn
- Rotomoulded cabinet available in grey or white
- Built-in passive LICC crossover with AMCDP protection
- 1 x 8" woofer with 1.5" voice coil
- 1 x 1.4" voice coil RCF Precision neodymium compression driver

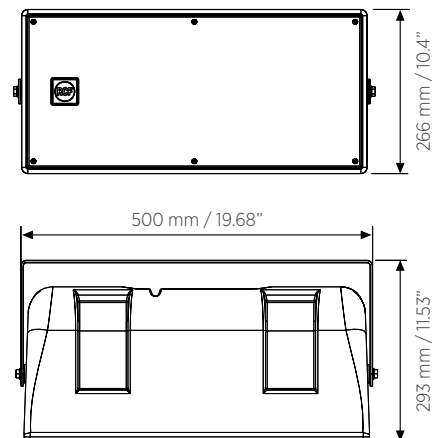

#### RELATED ACCESSORIES

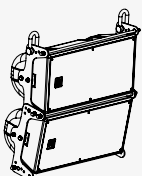

#### AC P08 A-BR

p.n. 13360118

Cluster brackets for P 3108 and P 1108T (including 4 brackets to cluster 2 speakers)





## SPECIFICATIONS

### P 1108T

p.n. 13000203 Grey - p.n. 13100084 White

#### Acoustical specifications

Frequency Response (-10dB):	80 Hz ÷ 20000 Hz
Max SPL @ 1m:	121 dB
Horizontal coverage angle:	90°
Vertical coverage angle:	60°
Directivity index Q:	11
System Sensitivity:	95 dB

#### Power section

Amplification:	Full Range
Nominal Impedance:	16 ohm
Power Handling:	100 W
Peak Power Handling:	400 W PEAK
Recommended Amplifier:	200 W
Protections:	PTC
Crossover Frequencies:	2200 Hz

#### Transducers

Compression Driver:	1 x 1.0", 1.4" v.c
Woofers:	8", 1.5" v.c

#### Input/Output section

Input connectors:	Neoprene Cable
Constant Voltage Transformer:	100 V
Power selection 1:	60 W - 167 ohm
Power selection 2:	30 W - 333 ohm
Power selection 3:	15 W - 667 ohm

#### Standard compliance

IP protection grade:	IP 55
Safety agency:	CE compliant

#### Physical specifications

Cabinet/Case Material:	PE Low Density
Hardware:	4 x M8 + U-Bracket and Pair of spacers
Grille:	Aluminum with waterproof clothing
Color:	Grey, White - RAL 9003
Dimensions (H x W x D):	10.47" x 19.41" x 9.84"   266 x 493 x 250 mm
Weight:	26.01 lb   11.8 kg

RESPONSE 1W/1m

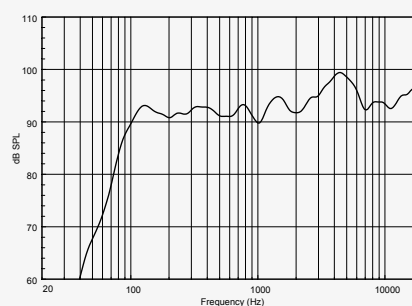

IMPEDANCE

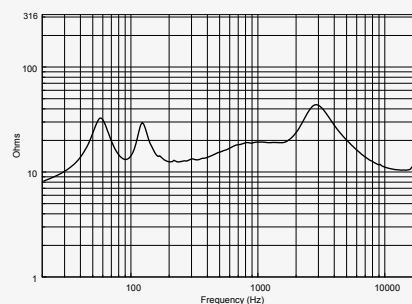

BEAMWIDTH vs. FREQUENCY

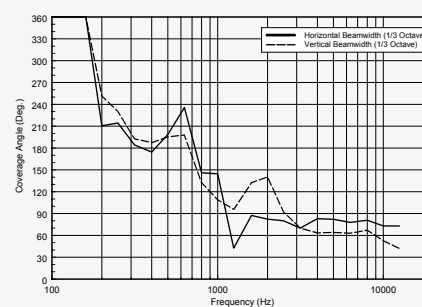

DIRECTIVITY INDEX AND Q

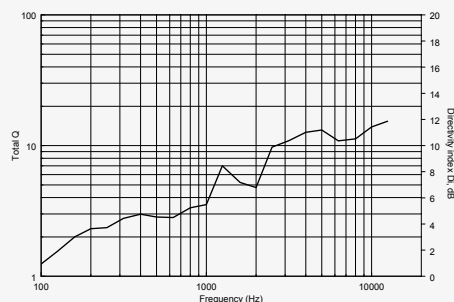

# P 6215

## P SERIES



### P 6215

#### OUTDOOR/INDOOR TWO-WAY COAXIAL SPEAKER SYSTEM

The P 6215 is a weatherproof full range, wide-dispersion, coaxial two-way loudspeaker system for very high output and long-throw applications. The speaker can be installed individually or coupled in array configurations. The low-frequency transducer is a 15" neodymium woofer, the high-frequency section combines a 1.3" neodymium RCF Precision compression driver with a 2.5" diaphragm assembly centrally mounted in the throat of the LF driver and loaded on a constant directivity CMD horn for smooth, wide dispersion. Internal circuit provides low crossover frequency for accurate vocal intelligibility and Active Mosfet Compression Driver Protection (AMCDP). The single-piece roto-molded cabinet is fully UV protected and meets IP-55 standard requirements, equipped with M10 brass inserts (12x), and one durable and corrosion-resistant 316P stainless steel U-Bracket with f spacers (2x) for 90° mounting. The aluminum grille cover is powder coated with water-repellent backing material and has a rotatable logo plate.

- 134 dB SPL Max, 600W RMS
- Weatherproof IP55 cabinet with UV protection
- Rotomoulded cabinet available in white or black
- 60° x 60° conical CMD horn
- One 15" high-output neodymium LF transducer
- One RCF Precision 2.5" neodymium C. Driver
- Active Mosfet Compression Driver Protection
- 12 brass suspension points (M10)

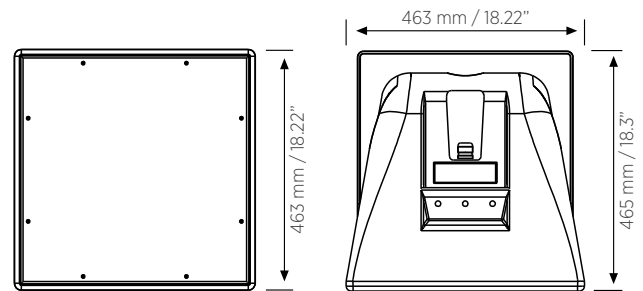

#### RELATED ACCESSORIES

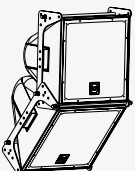

#### C-BR 2X P15

p.n. 13360094

Kit including 4 cluster brackets for P 6215  
(4 brackets cluster 2 speakers)





## SPECIFICATIONS

### P 6215

p.n. 13000131 Grey - p.n. 13100083 White

#### Acoustical specifications

Frequency Response (-10dB):	75 Hz ÷ 20000 Hz
Max SPL @ 1m:	134 dB
Horizontal coverage angle:	60°
Vertical coverage angle:	60°
Directivity index Q:	13
System Sensitivity:	100 dB

#### Power section

Amplification:	Full Range
Nominal Impedance:	8 ohm
Power Handling:	600 W
Peak Power Handling:	2400 W PEAK
Recommended Amplifier:	1200 W
Protections:	Dynamic active mosfet
Crossover Frequencies:	1100 Hz

#### Transducers

Compression Driver:	1.3" neo, 2.5" v.c
Woofer:	Coaxial 15" neo, 3.0" v.c

#### Input/Output section

Input connectors:	Neoprene Cable
-------------------	----------------

#### Standard compliance

IP protection grade:	IP 55
Safety agency:	CE compliant

#### Physical specifications

Cabinet/Case Material:	PE Low Density
Hardware:	12 x M10 + U-Bracket and Pair of spacers
Grille:	Aluminum with waterproof clothing
Color:	Grey, White - RAL 9003
Dimensions (H x W x D):	18.23" x 18.23" x 17.05"   463 x 463 x 433 mm
Weight:	37.48 lb   17 kg

RESPONSE 1W/1m

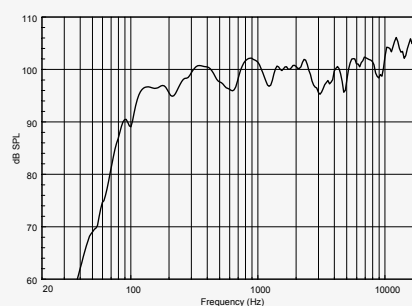

IMPEDANCE

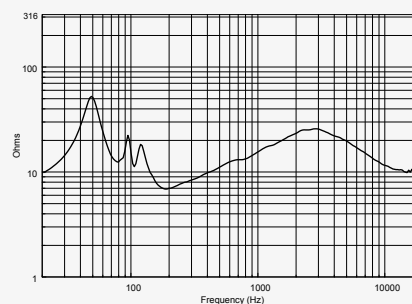

BEAMWIDTH vs. FREQUENCY

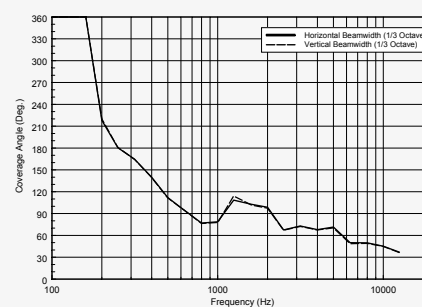

DIRECTIVITY INDEX AND Q

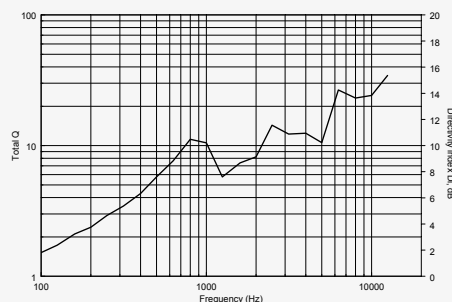

# 3115

## P SERIES



### P 3115T

#### OUTDOOR/INDOOR TWO-WAY COAXIAL SPEAKER SYSTEM

The P 3115T is a weatherproof full range, wide-dispersion, coaxial two-way loudspeaker system for a variety of professional indoor or outdoor applications. The speaker can be installed individually or coupled in array configurations. The low-frequency transducer is a 15" woofer with a 3" voice coil. The high-frequency section combines a 1.3" RCF Precision compression driver with a 2.5" diaphragm assembly centrally mounted in the throat of the LF driver and loaded on a constant directivity CMD horn for smooth, wide dispersion. The P3115-T features a selectable line transformer for 70 - 100 volt applications, built-in LICC crossover, and Active Mosfet Compression Driver Protection (AMCDP). The single-piece roto-molded cabinet is fully UV protected and meets IP-55 standard requirements, equipped with M10 brass inserts (12x), and a durable and corrosion-resistant 316P stainless steel U-Bracket with spacers (2x) for 90° mounting. The aluminum grille cover is powder coated with water-repellent backing material and has a rotatable logo plate.

- Cabinet is a single piece rotational moulded in medium density polyethylene, fully UV protected and waterproof IP 55
- Front grille in custom perforated aluminium with open-cell fibres and water repellent woven fabric backing
- Stainless steel bracket
- 15" high-output LF transducer with 2.5" voice coil
- RCF Precision 1" Compression Driver with 1.5" voice coil
- 90° x 60° constant directivity horn
- 10° X 20° enclosure sides for array configurations
- Active Mosfet Compression Driver Protection
- 12 brass suspension points (M10)
- Line transformer

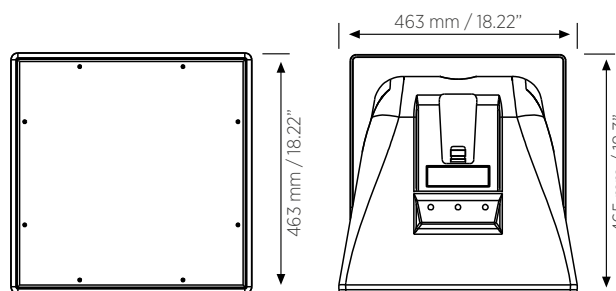

#### RELATED ACCESSORIES

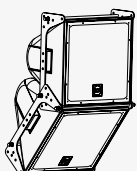

#### C-BR 2X P15

p.n. 13360094

Kit including 4 cluster brackets for P 3115T (4 brackets cluster 2 speakers)





## SPECIFICATIONS

### P 3115T

p.n. 13000135 Grey - p.n. 13100082 White

#### Acoustical specifications

Frequency Response (-10dB):	75 Hz ÷ 20000 Hz
Max SPL @ 1m:	129 dB
Horizontal coverage angle:	90°
Vertical coverage angle:	60°
Directivity index Q:	13
System Sensitivity:	98 dB

#### Power section

Amplification:	Full Range
Nominal Impedance:	16 ohm
Power Handling:	300 W
Peak Power Handling:	1200 W PEAK
Recommended Amplifier:	600 W
Protections:	Dynamic active mosfet
Crossover Frequencies:	1300 Hz

#### Transducers

Compression Driver:	1.0", 1.5" v.c
Woofer:	Coaxial 15", 2.5" v.c

#### Input/Output section

Input connectors:	Neoprene Cable
Constant Voltage Transformer:	100 V
Power selection 1:	120 W - 83 ohm
Power selection 2:	60 W - 167 ohm
Power selection 3:	30 W - 333 ohm

#### Standard compliance

IP protection grade:	IP 55
Safety agency:	CE compliant

#### Physical specifications

Cabinet/Case Material:	PE Low Density
Hardware:	12 x M10 inserts + U-brackets and pair of spacers
Grille:	Aluminum with waterproof clothing
Color:	Grey, White - RAL 9003
Dimensions (H x W x D):	18.23" x 18.23" x 17.05"   463 x 463 x 433 mm
Weight:	40.57 lb   18.4 kg

RESPONSE 1W/1m

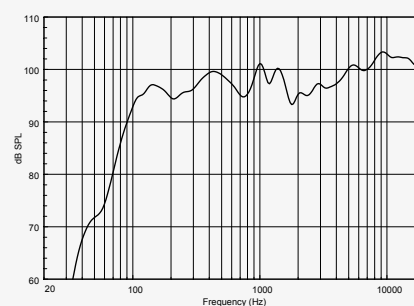

IMPEDANCE

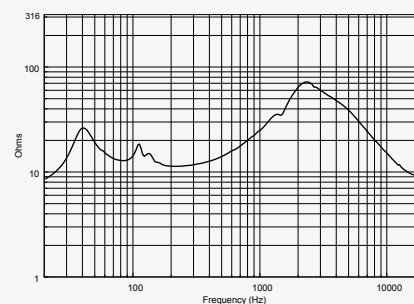

BEAMWIDTH vs. FREQUENCY

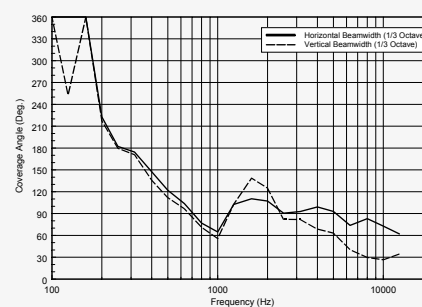

DIRECTIVITY INDEX AND Q

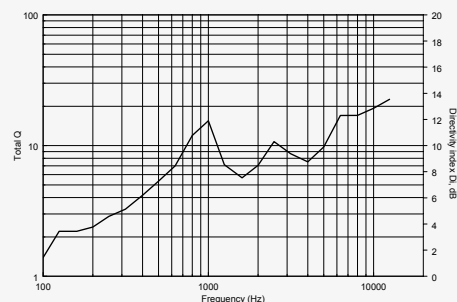

# 2110

## P SERIES



### P 2110T

#### OUTDOOR/INDOOR TWO-WAY COAXIAL SPEAKER SYSTEM

The P 2110T is a weatherproof full-range, wide-dispersion, coaxial two-way loudspeaker system for a variety of professional indoor or outdoor applications. The speaker can be installed individually or coupled in array configurations. The low-frequency transducer is a 10" woofer with a 2.5" voice coil. The high-frequency section combines a 1" RCF Precision compression driver with a 1.5" diaphragm assembly centrally-mounted in the throat of the LF driver, and loaded on a constant directivity CMD horn for smooth, wide dispersion. The P 2110T features a selectable line transformer for 70 - 100 volt applications, built-in LICC crossover, and Active Mosfet Compression Driver Protection (AMCDP). The single-piece roto-molded cabinet is fully UV protected and meets IP-55 standard requirements. Included are M10 brass inserts (12 x) and one durable corrosion-resistant 316P stainless steel U-Bracket with spacers (2x) for 90° mounting. The aluminum grille cover is powder coated with water-repellent backing material and a rotatable logo plate.

- 124 dB SPL Max, 200W RMS
- Weatherproof IP55 cabinet with UV protection
- Line transformer
- 90° x 40° CMD constant directivity horn
- 10" high-output LF transducer with 2.5" voice coil
- RCF Precision 1" C. Driver with 1.5" voice coil
- 12 brass suspension points (M10)
- Roto-moulded single piece cabinet

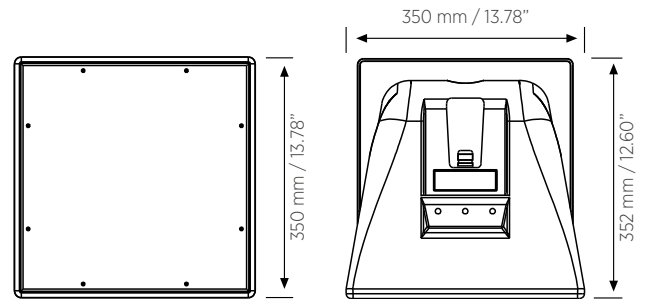

#### RELATED ACCESSORIES

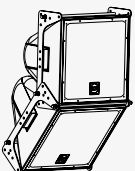

#### C-BR 2X P10

p.n. 13360095

Kit including 4 brackets to cluster 2 P 2110T speakers







## SPECIFICATIONS

### P 2110T

p.n. 13000125

#### Acoustical specifications

Frequency Response (-10dB):	95 Hz ÷ 20000 Hz
Max SPL @ 1m:	124 dB
Horizontal coverage angle:	90°
Vertical coverage angle:	40°
Directivity index Q:	11
System Sensitivity:	95 dB

#### Power section

Amplification:	Full Range
Nominal Impedance:	16 ohm
Power Handling:	200 W
Peak Power Handling:	800 W PEAK
Recommended Amplifier:	400 W
Protections:	Dynamic active mosfet
Crossover Frequencies:	2000 Hz

#### Transducers

Compression Driver:	1.0", 1.5" v.c
Woofer:	Coaxial 10", 2.5" v.c

#### Input/Output section

Input connectors:	Neoprene Cable
Constant Voltage Transformer:	100 V
Power selection 1:	60 W - 167 ohm
Power selection 2:	30 W - 333 ohm
Power selection 3:	15 W - 667 ohm

#### Standard compliance

IP protection grade:	IP 55
Safety agency:	CE compliant

#### Physical specifications

Cabinet/Case Material:	PE Low Density
Hardware:	12 x M8 inserts + U-brackets and pair of spacers
Grille:	Aluminum with waterproof clothing
Color:	Grey
Dimensions (H x W x D):	13.78" x 13.78" x 12.60"   350 x 350 x 320 mm
Weight:	29.54 lb   13.4 kg

RESPONSE 1W/1m

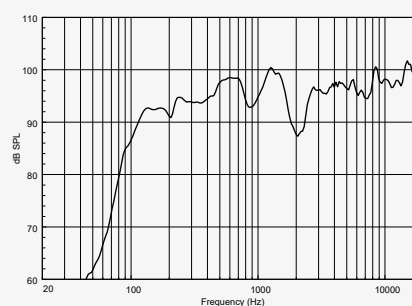

IMPEDANCE

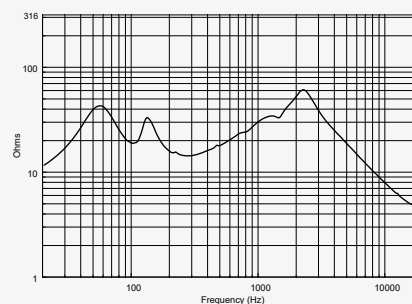

BEAMWIDTH vs. FREQUENCY

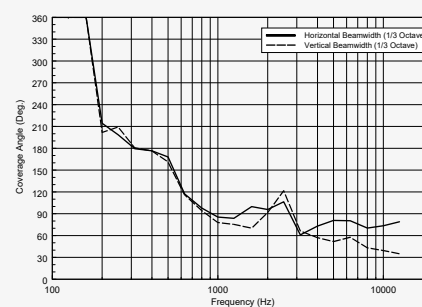

DIRECTIVITY INDEX AND Q

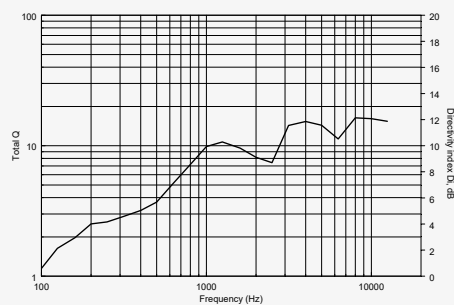

# 8015

## P SERIES



### P 8015S

#### OUTDOOR/INDOOR SUBWOOFER

P 8015S is a weatherproof bass reflex subwoofer equipped with a 15" low-frequency neodymium transducer with a 4" voice coil offering power and efficiency for a variety of professional outdoor or indoor applications. The P 8015S has been specifically designed to reinforce the low-frequency range in P Series speakers array systems. The single-piece roto-molded cabinet is fully UV protected and meets IP-55 standard requirements (International Protection Rating), equipped with M10 brass inserts (12x) and a durable and corrosion-resistant stainless steel U-Bracket and spacers (2x) for 90° mounting. The aluminum grille cover is powder coated with a water-repellent fabric backing.

- 132 dB max SPL, 800 W RMS
- Weatherproof IP55 cabinet with UV protection
- Rotomoulded single piece cabinet
- Aluminum grille and 316P stainless steel bracket
- Arrayable bass-reflex compact subwoofer
- 15" high power neodymium woofer with 4" voice coil
- 12 brass suspension points (M10)

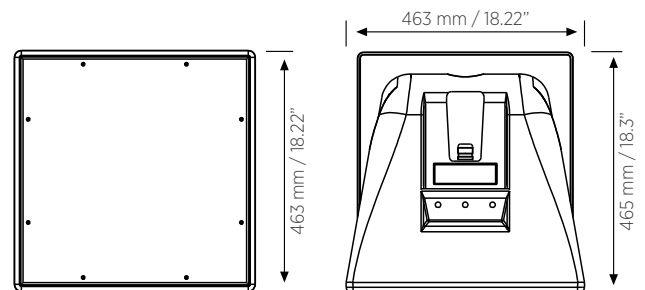

#### RELATED ACCESSORIES

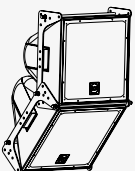

#### C-BR 2X P15

p.n. 13360094

Kit including 4 cluster brackets for P 8015S (4 brackets cluster 2 speakers)





## SPECIFICATIONS

### P 8015S

p.n. 13000230

#### Acoustical specifications

Frequency Response (-10dB):	50 Hz ÷ 200 Hz
Max SPL @ 1m:	132 dB
System Sensitivity:	97 dB

#### Power section

Amplification:	Full Range
Nominal Impedance:	8 ohm
Power Handling:	800 W
Peak Power Handling:	3200 W PEAK
Recommended Amplifier:	1600 W

#### Transducers

Woofer:	15" neo, 4.0" v.c
---------	-------------------

#### Input/Output section

Input connectors:	Neoprene Cable
-------------------	----------------

#### Standard compliance

IP protection grade:	IP 55
Safety agency:	CE compliant

#### Physical specifications

Cabinet/Case Material:	PE Low Density
Hardware:	12 x M10 + U bracket and pair of spacers
Grille:	Aluminum with waterproof clothing
Color:	Black
Dimensions (H x W x D):	18.23" x 18.23" x 17.05"   463 x 463 x 433 mm
Weight:	36.38 lb   16.5 kg

RESPONSE 1W/1m

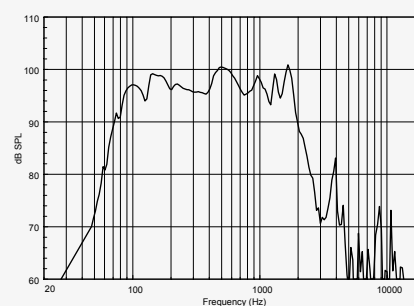

IMPEDANCE

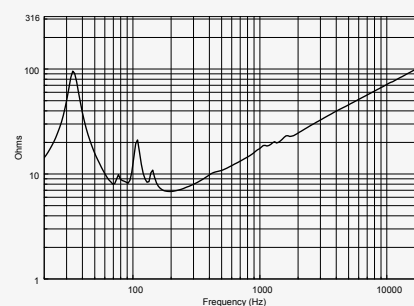

# 725 ART SERIES

## ART 725 MK4

### PASSIVE TWO-WAY SPEAKER

ART 725 MK4 is a passive two-way system with an accurate acoustic design for club installations and live music. Thanks to the high quality compression driver with a 3" voice coil and the 15" woofer, the ART 725 MK4 delivers clear high frequencies, punchy bass and full and precise mid frequencies. The new aluminium rear panel is equipped with Speakon in/out connectors.

- 133 dB Max SPL
- 650 W AES power handling
- 1.4" Titanium C. Driver, 3.0" v.c. Neodymium
- 15" woofer, high power, 3.5" voice coil
- 1400 Hz crossover point for perfect vocal reproduction
- 90°x60°, wide dispersion constant directivity horn



#### 3.0" SUPERIOR COMPRESSION DRIVERS

The ART 725 is a unique speaker in its category. The titanium dome, 3.0" voice coil neodymium compression driver offers a unique vocal clarity and sound projection.

#### RELATED ACCESSORIES



#### H-BR 2X ART 715 p.n. 13360105

Horizontal bracket. Adjustable inclination.



#### CVR ART 725

p.n. 13360115

Protection cover for ART 725. Protects the speaker from scratches and hits. Strong nylon construction.

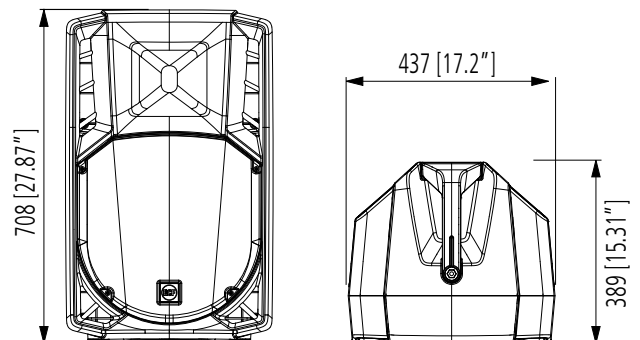

#### POWERFUL WOOFER

The 15" neodymium woofer offers an extremely linear response and a precise, deep low frequency control. The transducers are produced using the most advanced assembly technologies.

#### COMPONENT SAFETY

LICC (Low Impedance Compensated Crossover) with aluminium housed resistors and integrated heat sink to improve durability.



## SPECIFICATIONS

### ART 725 MK4

p.n. 13000548

#### Acoustical specifications

Frequency Response (-10dB):	55 Hz ÷ 20000 Hz
Max SPL @ 1m:	133 dB
Horizontal coverage angle:	90°
Vertical coverage angle:	60°
Directivity index Q:	11
System Sensitivity:	99 dB

#### Power section

Amplification:	Full Range
Nominal Impedance:	8 ohm
Power Handling:	700 W
Peak Power Handling:	2800 W PEAK
Recommended Amplifier:	1400 W
Crossover Frequencies:	1400 Hz

#### Transducers

Compression Driver:	1 x 1.4" neo, 3.0" v.c
Woofer:	15" neo, 3.5" v.c

#### Input/Output section

Input connectors:	Speakon® NL4
Output connectors:	Speakon® NL4

#### Standard compliance

Safety agency:	CE compliant
----------------	--------------

#### Physical specifications

Cabinet/Case Material:	PP Composite
Hardware:	2 x M10
Handles:	1 Top, 2 Side
Pole mount/Cap:	Yes
Grille:	Steel
Color:	Black
Dimensions (H x W x D):	27.87" x 17.2" x 15.31"   708 x 437 x 389 mm
Weight:	45.19 lb   20.5 kg

RESPONSE 1W/1m

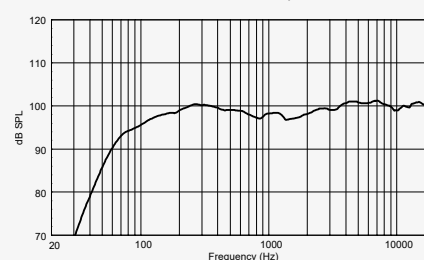

IMPEDANCE

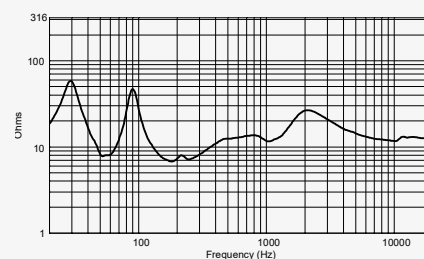

# SUB SERIES

## S 8028 II

### BASS REFLEX SUBWOOFER



The S8028 II is a very high-output, high power bass reflex subwoofer. The system is equipped with two advanced, hyperventated 18" RCF precision woofers mounted in a bass reflex configuration. The cabinet design is optimised to achieve tight and maximised output. Each 18" features massive vented magnets and 4" copper voice coil and represents the state of the art of RCF precision transducers technology. The system is able to produce a Max SPL of 141 dB and handles 3000 Watts AES. The cabinet features two Neutrik Speakon™ connectors in a recessed input plate. A M20 pole mount adaptor is provided on the top of the cabinet.

- 2 x 18" high-efficiency 4.0" voice-coil woofer with Inside/Outside Coil Technology
- 141 dB maximum sound pressure level
- Response down to 30 Hz
- System Power rating 3000 Watt RMS
- M20 standard pole mount in top section of cabinet
- Baltic Birch cabinet painted with black, heavy duty, textured epoxy
- Recessed Speakon NL4 Input/Output
- Protective metal grille, polyester fabric coated

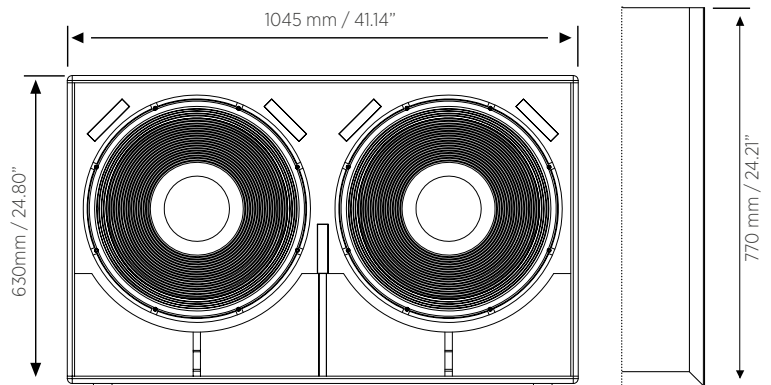

### 2 X 18" PROFESSIONAL WOOFER

- 4-inch, fiberglass inside/outside copper voice coil
- Dual Forced Hyperventing System
- Dual spider design with silicon based dampening control
- Triple-roll surround and corrugated straight cone geometry



#### CONNECTORS

Connections are made through two Neutrik Speakon NL4 connectors (audio input and parallel link output).



#### HANDLES

2 on side



**SPECIFICATIONS**

**S 8028 II**

p.n. 13000391

**Acoustical specifications**

Frequency Response (-10dB):	30 Hz ÷ 200 Hz
Max SPL @ 1m:	141 dB
System Sensitivity:	101 dB

**Power section**

Amplification:	Full Range
Nominal Impedance:	4 ohm
Power Handling:	3000 W
Peak Power Handling:	12000 W PEAK
Recommended Amplifier:	6000 W

**Transducers**

Woofer:	2 x 18", 4.0" v.c
---------	-------------------

**Input/Output section**

Input connectors:	Speakon® NL4
Output connectors:	Speakon® NL4

**Standard compliance**

Safety agency:	CE compliant
----------------	--------------

**Physical specifications**

Cabinet/Case Material:	Baltic birch plywood
Handles:	Integrated hand carry points
Pole mount/Cap:	Yes
Grille:	Metal
Dimensions (H x W x D):	25.16" x 41.14" x 30.31"   639 x 1045 x 770 mm
Weight:	176.37 lbs   80 kg

RESPONSE 1W/1m

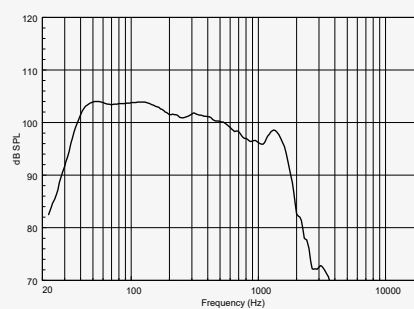

IMPEDANCE

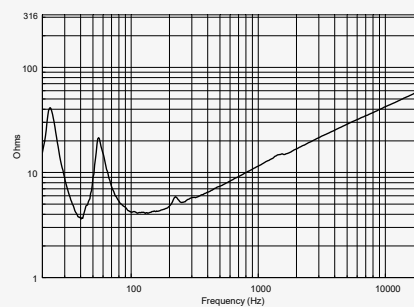

# 8018 SUB SERIES



## S 8018 II

### HIGH-EFFICIENCY SUBWOOFER

The S8018 II high-efficiency subwoofer is the ideal low-frequency extension to complement RCF installed systems. The low-frequency transducer is a hypervented vented, high excursion RCF Precision 18" woofer with a 4" inside/outside voice coil to minimize power compression and extend the life of the product. Using bass-reflex loading the subwoofer design ensures an efficient acoustic response down to 30 Hz. The Baltic birch plywood enclosure is painted with black, heavy duty, textured epoxy. The front is protected by a strong powder coated metal grille. The cabinet features two Neutrik Speakon™ connectors in a recessed input plate. A M20 pole mount adaptor is provided on the top of the cabinet, integrated hand carry points on the cabinet sides.

- 18" high-efficiency 4" voice-coil woofer with Inside/Outside Coil Technology
- 137 dB maximum sound pressure level
- Response down to 30 Hz
- Rectangular box enclosure with protective metal grille
- 35 mm standard pole mount in top section of cabinet
- Baltic Birch cabinet painted with black, heavy duty, textured epoxy
- Integrated hand carry points

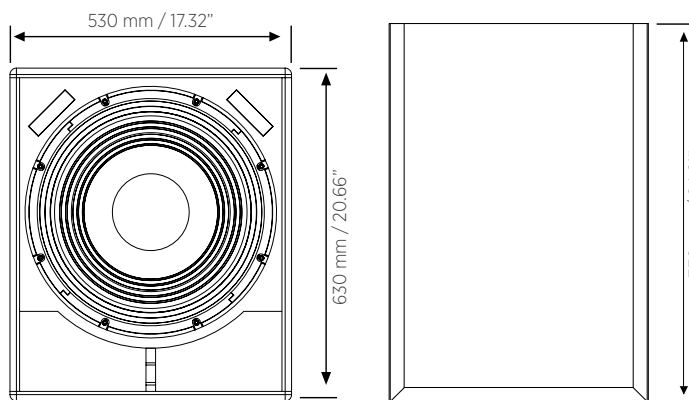

### 1 X 18" PROFESSIONAL WOOFER

- 4-inch, fiberglass inside/outside copper voice coil
- Dual Forced Hyperventing System
- Dual spider design with silicon based dampening control
- Triple-roll surround and corrugated straight cone geometry



#### CONNECTORS

Connections are made through two Neutrik Speakon NL4 connectors (audio input and parallel link output).



#### HANDLES

2 on side





## SPECIFICATIONS

### S 8018 II

p.n. 13000390

#### Acoustical specifications

Frequency Response (-10dB):	30 Hz ÷ 200 Hz
Max SPL @ 1m:	137 dB
System Sensitivity:	100 dB

#### Power section

Amplification:	Full Range
Nominal Impedance:	8 ohm
Power Handling:	1500 W
Peak Power Handling:	6000 W PEAK
Recommended Amplifier:	3000 W

#### Transducers

Woofer:	18" neo, 4.0" v.c
---------	-------------------

#### Input/Output section

Input connectors:	Speakon® NL4
Output connectors:	Speakon® NL4

#### Standard compliance

Safety agency:	CE compliant
----------------	--------------

#### Physical specifications

Cabinet/Case Material:	Baltic birch plywood
Handles:	Integrated hand carry points
Pole mount/Cap:	Yes
Grille:	Metal
Color:	Black
Dimensions (H x W x D):	25.16" x 20.87" x 30.31"   639 x 530 x 770 mm
Weight:	94.8 lbs   43 kg

RESPONSE 1W/1m

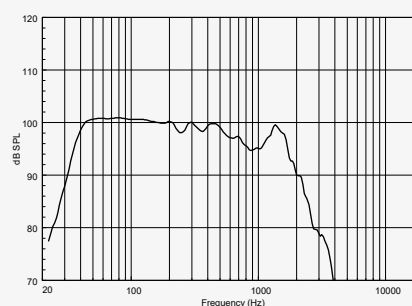

IMPEDANCE

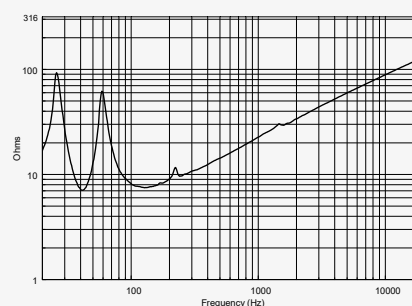

# 8015

## SUB SERIES

### S 8015 II

#### HIGH-EFFICIENCY SUBWOOFER

The S8015 II is a compact, high-output, bass reflex subwoofer. The system is equipped with an advanced, hypervented 15" RCF precision woofer. It features massive ceramic magnet and high excursion 4" copper voice coil. The cabinet is designed to achieve tight and maximised output. The system is able to produce a Max SPL of 133 dB and handles 1000 Watts AES. The loudspeaker enclosure shape is rectangular and the cabinet is constructed of multi-ply Baltic birch plywood and finished in a very resistant, textured, polyurethane black paint. It features a M20 polemount receptacle, rubber feet, 2 x recessed handles. The front steel grille is epoxy powder coated.



- 15" high-efficiency RCF Precision 4" voice-coil woofer with Inside/Outside Coil Technology
- 133 dB maximum sound pressure level
- Response down to 35 Hz
- Rectangular box enclosure with protective metal grille
- 35 mm standard pole mount in top section of cabinet
- Baltic Birch cabinet painted with black, heavy duty, textured epoxy
- Integrated hand carry points

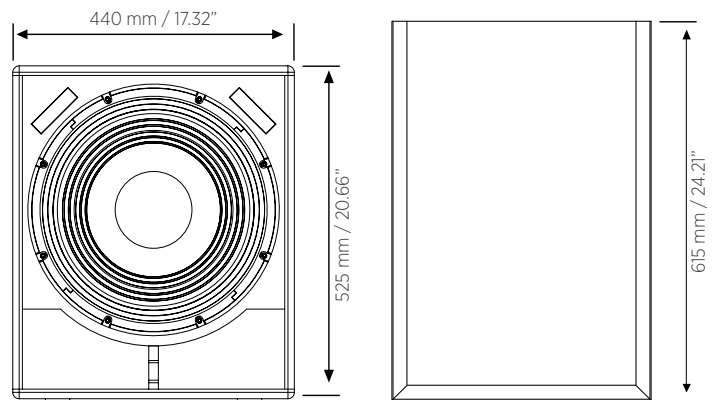

#### 1 X 15" PROFESSIONAL WOOFER

- 4-inch, fiberglass inside/outside copper voice coil
- Dual Forced Hyperventing System
- Dual spider design with silicon based dampening control
- Triple-roll surround and corrugated straight cone geometry



#### CONNECTORS

Connections are made through two Neutrik Speakon NL4 connectors (audio input and parallel link output).



#### HANDLES

2 on side



**SPECIFICATIONS**

**S 8015 II**

p.n. 13000398

**Acoustical specifications**

Frequency Response (-10dB):	35 Hz ÷ 200 Hz
Max SPL @ 1m:	133 dB
System Sensitivity:	98 dB

**Power section**

Amplification:	Full Range
Nominal Impedance:	8 ohm
Power Handling:	1500 W
Peak Power Handling:	6000 W PEAK
Recommended Amplifier:	3000 W

**Transducers**

Woofer:	15" neo, 4.0" v.c
---------	-------------------

**Input/Output section**

Input connectors:	Speakon® NL4
Output connectors:	Speakon® NL4

**Standard compliance**

Safety agency:	CE compliant
----------------	--------------

**Physical specifications**

Cabinet/Case Material:	Baltic birch plywood
Handles:	Integrated hand carry points
Pole mount/Cap:	Yes
Grille:	Steel
Color:	Black
Dimensions (H x W x D):	20.83" x 17.32" x 24.21"   529 x 440 x 615 mm
Weight:	74.96 lbs   34 kg

RESPONSE 1W/1m

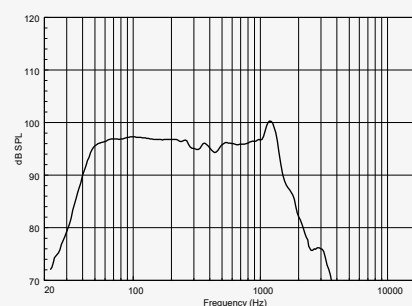

IMPEDANCE

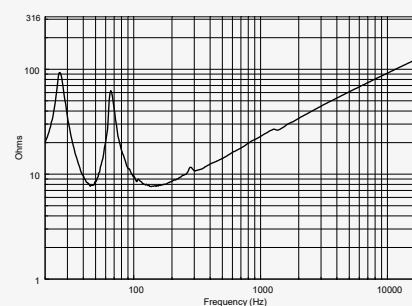

# 8015

## SUB SERIES

### S 8015LP

#### BASS REFLEX SUBWOOFER



The S8015 LP is an extremely compact, high output, band-pass subwoofer able to deliver tight and fast controlled bass response. The new high power high sensitivity 15" woofer is the result of the latest RCF experience in sub-bass transducers and compact subwoofer design and manufacturing. The band-pass configuration offers a significant acoustic impact resulting in a fast and controlled reproduction of the bass frequency range. It is capable of a power of 1 kW RMS and able to deliver a MAX SPL in excess of 135 dB. The cabinet's shape is unobtrusive rectangular low profile to be used under sofa or under limited height stages; the cabinet is constructed of Baltic Birch plywood and finished in a very resistant, textured black paint. Rubber feet are also installed.

- 15" high-efficiency RCF Precision 4" voice-coil woofer with Inside/Outside Coil Technology
- Bandpass woofer
- 135 dB Max SPL
- Response down to 43 Hz
- Rectangular box enclosure
- Baltic Birch cabinet finished in a very resistant, textured black paint with rubber feet

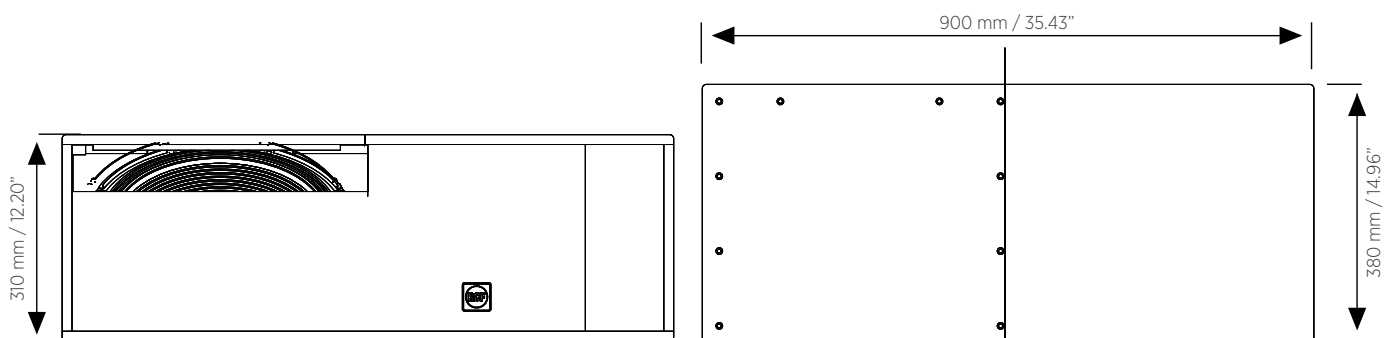

#### 1 X 15" PROFESSIONAL WOOFER

- 4-inch, fiberglass inside/outside copper voice coil
- Dual-forced air ventilation and 15mm top plate for minimum power compression
- Dual spider design with silicon based dampening control
- Triple-roll surround and corrugated straight cone geometry





## SPECIFICATIONS

### S 8015LP

p.n. 13000168

#### Acoustical specifications

Frequency Response (-10dB):	43 Hz ÷ 250 Hz
Max SPL @ 1m:	135 dB
System Sensitivity:	99 dB

#### Power section

Amplification:	Full Range
Nominal Impedance:	8 ohm
Power Handling:	800 W
Peak Power Handling:	3200 W PEAK
Recommended Amplifier:	1600 W

#### Transducers

Woofer:	15", 4.0" v.c
---------	---------------

#### Input/Output section

Input connectors:	Speakon® NL4
Output connectors:	Speakon® NL4

#### Standard compliance

Safety agency:	CE compliant
----------------	--------------

#### Physical specifications

Cabinet/Case Material:	Baltic birch plywood
Color:	Black
Dimensions (H x W x D):	12.20"x 35.43"x 14.96"   310 x 900 x 380 mm
Weight:	55.56 lb   25.2 kg

RESPONSE 1W/1m

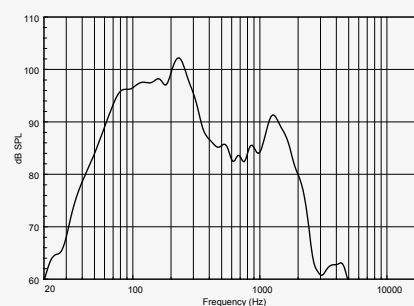

IMPEDANCE

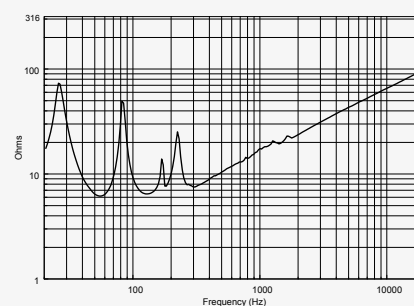

# 15 SUB SERIES

## S 15

### BASS REFLEX SUBWOOFER

S 15 is a high-power, compact subwoofer system ideal for installations where the physically small size and impact of a 12" driver are desired. Extending the frequency response below 35Hz, this highly efficient design is capable of providing output levels normally associated with considerably larger enclosures. A system suited to music playback in applications ranging from clubs, bars and cafes, right through to theatres and corporate applications. The low-frequency transducer is a 15" woofer with a 2.5" voice coil. Its design is the result of the latest refinements in compact subwoofer production, resulting in a fast and controlled reproduction of the bass frequency range. It is particularly well-suited for high-quality multimedia applications.

- 500 W RMS power handling
- 126 dB max SPL
- 35 ÷ 200 Hz frequency range
- 1 x 15" high power woofer
- High quality plywood cabinet
- Steel front grille with clothing
- M20 standard pole mount in top section of cabinet
- 4 pole EUROBLOCK connector (audio input and parallel link output)

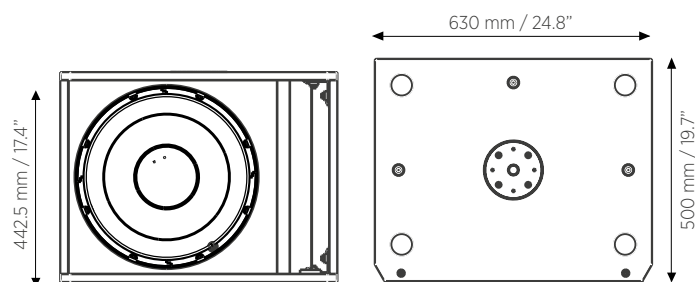

### POWERFUL LOWS

RCF subwoofers are the first choice of many sound engineers, due to their very high SPL levels at very low frequencies, smaller dimensions compared to the competitors, self-powered design, and impressive size/weight to SPL output ratio. Your audience will enjoy an engaging immersive musical experience.

### STATE OF THE ART TRANSDUCERS

The low-frequency transducers is a 15" woofer, with a 3" voice coil. Its design is the result of the latest refinements in RCF experiences in compact active and passive subwoofer design, resulting in a fast and controlled reproduction of the bass frequency range.

### RELATED ACCESSORIES



#### PNL IN-OUT AMPHENOL

p.n. 12399063

PNL IN-OUT AMPHENOL is an optional panel that allows to switch input/output connectors to AMPHENOL IP 67, making them fully weatherproof



#### PNL IN-OUT SPEAKON COMPACT M

p.n. 12399062

The EUROBLOCK connection panel can be replaced with female Neutrik SpeakON connection panel in seconds, thanks to the single connector on the back.



**SPECIFICATIONS**

**S 15**

p.n. 13000667

**Acoustical specifications**

Frequency Response (-10dB):	35 Hz ÷ 200 Hz
Max SPL @ 1m:	126 dB
System Sensitivity:	95 dB

**Power section**

Amplification:	Full Range
Nominal Impedance:	8 ohm
Power Handling:	500 W RMS
Peak Power Handling:	2000 W PEAK
Recommended Amplifier:	1000 W

**Transducers**

Woofer:	15", 3.0" v.c
---------	---------------

**Input/Output section**

Input connectors:	Euroblock
Output connectors:	Euroblock

**Standard compliance**

Safety agency:	CE compliant
----------------	--------------

**Physical specifications**

Cabinet/Case Material:	Plywood
Hardware:	12 x M10
Pole mount/Cap:	Yes
Grille:	Steel with clothing
Color:	Black
Dimensions (H x W x D):	17.44"x 24.8"x 19.69"   443 x 630 x 500 mm
Weight:	60.63 lbs   27.5 kg

RESPONSE 1W/1m

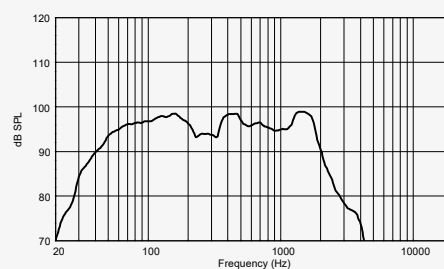

IMPEDANCE

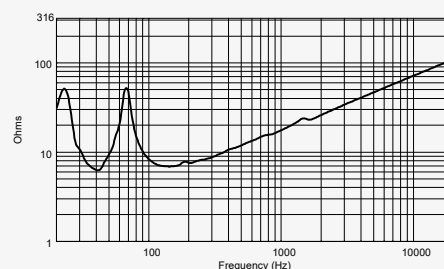

# 12 SUB SERIES

## S 12

### BASS REFLEX SUBWOOFER

S 12 is a high power, compact subwoofer system ideal for those installations where the physically small size and impact of a 12" driver are desired. Extending the frequency response of these systems to below 40Hz this highly efficient design is capable of providing output levels normally associated with considerably larger enclosures. A system suited to background music playback in applications ranging from clubs, bars and cafes, right through to theatres and AV presentations. The low-frequency transducer is a 12" woofer with a 2,5" voice coil. Woofer design is the result of the latest refinements in RCF experiences in compact active and passive subwoofer design, resulting in a fast and controlled reproduction of the bass frequency range.

- 400 W RMS power handling
- 125 dB max SPL
- 40 ÷ 200 Hz frequency range
- 1 x 12" high power woofer
- High quality plywood cabinet
- Steel front grille with clothing
- M20 standard pole mount in top section of cabinet
- 4 pole EUROBLOCK connector (audio input and parallel link output)

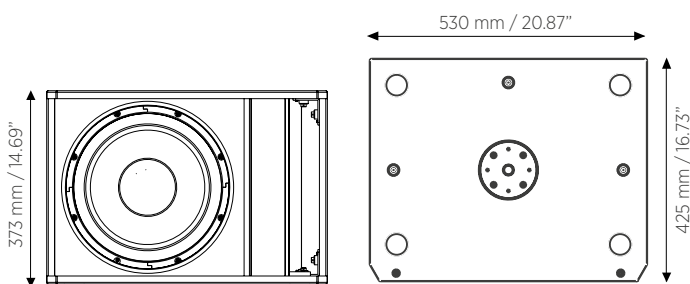

### POWERFUL LOWS

RCF subwoofers are the first choice of many sound engineers, due to their very high SPL levels at very low frequencies, smaller dimensions compared to the competitors, self-powered design, and impressive size/weight to SPL output ratio. Your audience will enjoy an engaging immersive musical experience.

### STATE OF THE ART TRANSDUCERS

The low-frequency transducers is a 12" woofer, with a 2,5" voice coil. Its design is the result of the latest refinements in RCF experiences in compact active and passive subwoofer design, resulting in a fast and controlled reproduction of the bass frequency range.

### RELATED ACCESSORIES



#### PNL IN-OUT AMPHENOL

p.n. 12399063

PNL IN-OUT AMPHENOL is an optional panel that allows to switch input/output connectors to AMPHENOL IP 67, making them fully weatherproof



#### PNL IN-OUT SPEAKON COMPACT M

p.n. 12399062

The EUROBLOCK connection panel can be replaced with female Neutrik SpeakON connection panel in seconds, thanks to the single connector on the back.





## SPECIFICATIONS

### S 12

p.n. 13000618

#### Acoustical specifications

Frequency Response (-10dB):	40 Hz ÷ 200 Hz
Max SPL @ 1m:	125 dB
System Sensitivity:	93 dB

#### Power section

Amplification:	Full Range
Nominal Impedance:	8 ohm
Power Handling:	400 W
Peak Power Handling:	1600 W PEAK
Recommended Amplifier:	800 W

#### Transducers

Woofer:	12", 2.5" v.c
---------	---------------

#### Input/Output section

Input connectors:	Euroblock
Output connectors:	Euroblock

#### Standard compliance

Safety agency:	CE compliant
----------------	--------------

#### Physical specifications

Cabinet/Case Material:	Plywood
Hardware:	12 x M10
Pole mount/Cap:	Yes
Grille:	Steel with clothing
Color:	Black
Dimensions (H x W x D):	14.69"x 20.87"x 16.73"   373 x 530 x 425 mm
Weight:	54.23 lbs   24.6 kg

RESPONSE 1W/1m

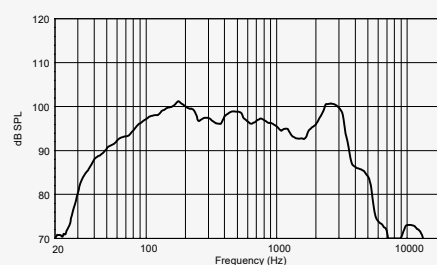

IMPEDANCE

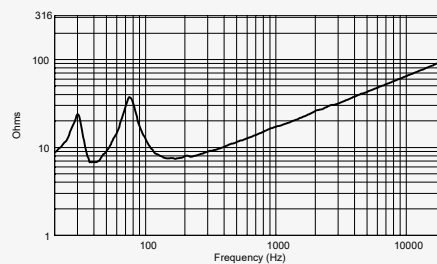

# 10 SUB SERIES



## S 10

### BASS REFLEX SUBWOOFER

S 10 is a high-power, compact subwoofer system ideal for installations where the physically small size and impact of a 10" driver are desired. Extending the frequency response below 50Hz, this highly efficient design is capable of providing output levels normally associated with considerably larger enclosures. A system suited to music playback in applications ranging from clubs, bars and cafes, right through to theatres and corporate applications. The low-frequency transducer is a 10" woofer with a 2.5" voice coil. Its design is the result of the latest refinements in compact subwoofer production, resulting in a fast and controlled reproduction of the bass frequency range. It is particularly well-suited for high-quality multimedia applications.

- 400W AES power handling
- 124 dB max SPL
- 50 ÷ 200 Hz frequency range
- 1 x 10" high-power woofer
- High-quality plywood cabinet
- Steel front grille with clothing
- M20 standard pole mount in the top section of the cabinet
- 4 pole EUROBLOCK connector (audio input and parallel link output)

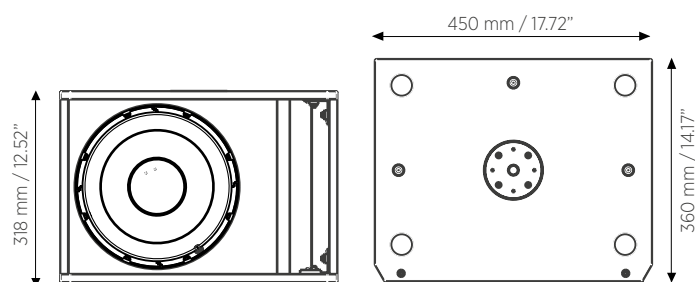

### POWERFUL LOWS

RCF subwoofers are the first choice of many sound engineers, due to their very high SPL levels at very low frequencies, smaller dimensions compared to the competitors, self-powered design, and impressive size/weight to SPL output ratio. Your audience will enjoy an engaging immersive musical experience.

### STATE OF THE ART TRANSDUCERS

The low-frequency transducers is a 10" woofer, with a 2,5" voice coil. Its design is the result of the latest refinements in RCF experiences in compact active and passive subwoofer design, resulting in a fast and controlled reproduction of the bass frequency range.

### RELATED ACCESSORIES



#### PNL IN-OUT AMPHENOL

p.n. 12399063

PNL IN-OUT AMPHENOL is an optional panel that allows to switch input/output connectors to AMPHENOL IP 67, making them fully weatherproof



#### PNL IN-OUT SPEAKON COMPACT M

p.n. 12399062

The EUROBLOCK connection panel can be replaced with female Neutrik SpeakON connection panel in seconds, thanks to the single connector on the back.



## SPECIFICATIONS

### S 10

p.n. 13000617

#### Acoustical specifications

Frequency Response (-10dB):	45 Hz ÷ 200 Hz
Max SPL @ 1m:	124 dB
System Sensitivity:	92 dB

#### Power section

Amplification:	Full Range
Nominal Impedance:	8 ohm
Power Handling:	400 W
Peak Power Handling:	1600 W PEAK
Recommended Amplifier:	800 W

#### Transducers

Woofer:	10", 2.5" v.c
---------	---------------

#### Input/Output section

Input connectors:	Euroblock
Output connectors:	Euroblock

#### Standard compliance

Safety agency:	CE compliant
----------------	--------------

#### Physical specifications

Cabinet/Case Material:	Plywood
Hardware:	12 x M10
Pole mount/Cap:	Yes
Grille:	Steel with clothing
Color:	Black
Dimensions (H x W x D):	12.52"x 17.72"x 14.17"   318 x 450 x 360 mm
Weight:	43.21 lbs   19.6 kg

RESPONSE 1W/1m

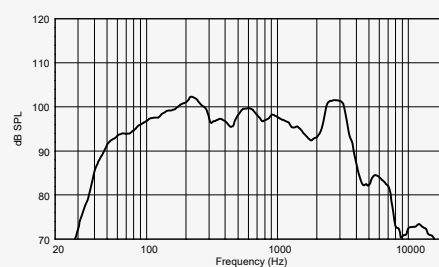

IMPEDANCE

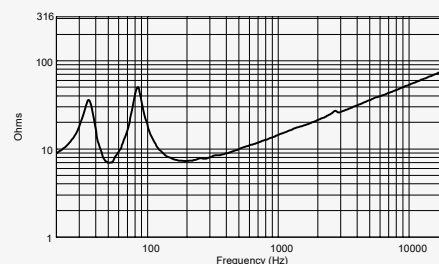

# XPS AMPLIFIERS

## XPS 16K - XPS 16KD

### FOUR CHANNELS DSP AMPLIFIER



XPS 16K offers a full package of high power amplification, innovative processing, analog and digital audio management in a single solution. It is a high power amplifier dedicated to RCF speaker systems with an onboard dedicated preset library. XPS 16K offers four independent, processed channels of audio amplification and is capable of driving all professional RCF speaker systems, with RDNet integration and Dante Networking (XPS 16KD). It is possible to discover, monitor and control a virtually unlimited number of amplifier. Users will find ready to use definable parametric equalizations, multiband compressors, RCF bass shaper, air absorption compensation, delays and levels. The time delay it is up to four second per channel. Most of settings and monitored parameters (channel information, presets, levels, status, grouping and naming as well as user presets) are also accessible through the front panel user interface, made of a capacitive 4.3" touch screen and an ergonomic rotary encoder.

- 4 x 4000 W continuous output power
- 20 ÷ 23000 Hz frequency range
- Full on-board processing
- RCF speakers' presets library
- Proprietary advanced algorithms
- Networked management via RDNet
- Native ethernet interface
- 4.3" TFT capacitive touch screen
- Dante Audio Network on XPS 16KD

### MODULAR POWER MANAGEMENT

XPS 16K provides extreme power density with 4 x 4000 W continuous power outputs in 2 RU space for both touring and installed sound systems. The unit features 4 analog and digital AES/EBU inputs/outputs, Dante Network (KD model), and a complete signal processing, tuning, and routing capability at 96 kHz. Redundancy and full scalability are granted by the advanced and modular design of the circuitry. A complete set of RCF speaker presets is available, with powerful signal processing for a complete system's tuning.

More than a power amplifier. XPS 16K supports the RCF philosophy with a power-agnostic approach, where the Sound

System Manager has complete freedom in choosing a powered or externally amplified modules for its system. XPS 16K offers balancing portability, weight, ease of installation, cabling, fast setup speed, and complete remote management of each connected device, via RDNet.

RCF's effort in assisting both installers and sound providers with the best audio technology and clear, powerful sound is at the core of the company's beliefs. Since 1949, providing both power amplifiers and transducers to the professional market, the RCF experience marks a new milestone with XPS 16K.



### TOTAL OPERATIONAL CONTROL

A large 4.3" TFT color capacitive touch panel provides full operational control of the amplifier. The user interface is clear and easy to use providing large touch buttons and a practical edit knob, with high contrast menus designed to avoid any ambiguity in very bright or sunny environments. Proprietary RDNet Over Ethernet Management Network and OSC protocol compatibility allow the Sound System Manager to have complete remote control of the amplifier.



### POWER-AGNOSTIC RDNet MANAGEMENT



RDNet will manage XPS amplifiers as middlemen between the user and the speaker, so the speaker will always be at the center of the scene, maintaining the usual control paradigm of RDNet software. The extensive RCF loudspeaker preset database is available within the amplifier and recallable via RDNet. The software Synoptic Table will show both passive devices and

active ones as fully featured speakers, while the amplifier will be seen as a simple controller for signal routing and maintenance controls. The user can also group speakers and manage advanced settings in a mixed fashion making no distinction between active or passive architecture.

### ROUTING



Set, for each output, main and backup inputs parameters, and routing strategy.

### PHYSICAL IN/OUT



Set analogue and digital input and output configuration.

# XPS AMPLIFIERS

## FAULT-TOLERANT ARCHITECTURE

RCF amplifier blocks are fully self-protecting and designed on an 'audio-at-all-times' principle, with all fault protection features individually implemented for each amplifier channel and power supply. XPS 16K implements several safety strategies with fast and slow protections at both firmware and hardware levels.

## FLEXIBLE SIGNAL PROCESSING

The comprehensive digital architecture of the amplifier features multiple inputs and outputs that can be easily routed to suit any project. Analog inputs 3 and 4 can be switched to 4 AES/EBU digital I/O ports. Each input can be routed to any of the four digital and power outputs. The advanced clocking management design provides low latency sample rate conversion with high-quality AD/DA converters up to 96 kHz. Each XPS 16K amplifier combines two 40-bit floating-point SHARC DSP chips at 96 kHz and two more 32-bit DSP chips to independently manage audio processing and signal routing for maximum sound quality and redundancy.

## SCALABILITY

XPS is a scalable system: system expansion only requires standard ethernet equipment. RDNet will detect any new devices on the network, take immediate control, and provide monitoring from a remote computer.

Scalability and Resilience concepts are interpenetrated in the so-called RDNet-OE converged network, which transports audio and control in a simple and safe way, with priority management.



## CONVERGENCE

XPS is a converged system: multiple interconnected devices don't need overabundant infrastructures. Dante and control networks converge to the same connector, simplifying cabling and reducing malfunction occurrences.



XPS 16K Rear view

XPS 16KD Rear view  
Dante Ports  
Primary and Secondary



## SPECIFICATIONS

### XPS 16K | XPS 16KD

### XPS 16K | XPS 16KD

#### Amplifier specifications

Amplifier Class:	D
Output power (EIAJ 8:32 all channels driven):	4 x 4000 W @ 2.7 ohm 4 x 2600 W @ 4 ohm 4 x 1400 W @ 8 ohm
Frequency Response (-3dB):	20 Hz ÷ 23000 Hz
Frequency Response (-3dB):	
SNR Analog inputs (unweighted):	111 dB
SNR Digital inputs (unweighted):	115 dB
Crosstalk:	<70 dB
THD+N (20 Hz ÷ 20000 Hz, 1000 W @ 4 ohm):	<0.2 %
Gain (linear mode @ 0 dB):	32 dB
Damping factor (@ 4 ohm, 20 Hz ÷ 1500 Hz):	>95
Max burst length (@ 50 Hz, CF = 7 dB, 4 ohm, 1% THD+N):	200 ms

#### Input section

Total number of inputs:	8	16
Line inputs:	4	
Line connectors:	XLR	
Digital inputs:	4	12
Digital connectors:	XLR	Ethercon, XLR
Digital type:	AES/EBU	AES/EBU, DANTE
General Purpose Inputs (GPI):	2	
Programmable GPI:	Yes	
Photo-coupled GPI:	2	

#### Output section

Signal output number:	4
Signal output connectors:	XLR
Power output connectors:	Speakon
General Purpose Outputs (GPO):	3
Programmable GPO:	Yes

#### Processing

DSP:	2 SHARC, 40-bit floating point, 96 kHz 2 ADAU 1442, 32-bit fixed point, 96 kHz
EQ Filters:	Peaking   HI/LO-shelving   HI/LO-pass (Butterworth, Linkwitz-Riley, Bessel)
Advanced algorithms:	FIRPHASE technology   BASS shaper   air compensation   mid-low correction   driver excursion control   dynamic PEQ   multi-band compressor   pilot tone detection   backup recovery strategy   impedance load measurement
Compressors:	RMS limiter   dynamic compressor   power limiter   thermal compressor
Delay:	0 ÷ 4000 ms (each channel)
Tone controls:	Yes
High-pass filter:	10 Hz ÷ 1000 Hz

Crossover:	2500 ÷ 3500 Hz
Automatic Gain Control (ACG):	Yes

#### Configuration and control

Configuration:	Front panel touch screen, PC Software
Network:	Gigabit ethernet
RCF speakers presets:	Yes
Priority:	Yes
Protocols for system integration:	Proprietary OSC based protocol, Q-SYS
RDNNet:	Yes

#### Protections

Protections:	Forced cooling   Short circuit   Thermal   DC   Fuses   VHF (Very High Frequencies)
--------------	--

#### Operating conditions

Temperature range	
Continuous operation:	-5°C ÷ +40°C / +23°F ÷ +104°F
Reduced output power:	-5°C to +50°C / +23°F to +122°F
Fan noise idle:	<35 dBA
Fan noise max:	<64 dBA

#### Power supply

Operating voltage:	90-240 V~ 50/60Hz
Nominal current requirements (@ 100-120 V):	30 A
Nominal current requirements (@ 200-240 V):	16 A
Power consumption standby:	20 W
Power consumption idle:	90 W
Power consumption max:	5800 W
Mains fuse:	Internal
Fuses Model:	-   F 315 mA H 100 V

#### Standard compliance

Safety agency:	CE compliant
----------------	--------------

#### Physical specifications

Cabinet/Case Material:	Metal
Handles:	2 metal handles for rack mount
Color:	Black
Rack mounting:	19", 2U

#### Size

Dimensions (H x W x D):	3.49"x 18.98"x 18.99" 88.7 x 482 x 482.4 mm
Weight:	15 kg / 33.07 lbs

#### Part Number

90-240V EU	12100037	12100064
90-240V UK	12100076	12100077
90-240V US	12100074	12100075

# QPS AMPLIFIERS

## QPS SERIES

FOUR CHANNELS PROFESSIONAL  
POWER AMPLIFIER

QPS Series products are high-performance, versatile power amplifiers for both touring and install applications, using sophisticated Class-HD topology with four single-channel outputs or one/two bridged outputs, parallel or stereo for up to 4 x 2500 W (QPS 10K) and up to 4 x 1500 W (QPS 6K) at 2 ohms. It features independent gain control, signal/clip and faults indicators, channels A and C XLR output link, parallel and bridge mode, and speakON output connectors. Three dip-switches allow setting the maximum output voltage peak for each channel among eight values. High-efficiency heat sinks and variable-speed fans can withstand the hardest heat conditions ensuring great power output stability over time. High quality, low distortion audio output, flawless reliability, and industry-standard speakON connectors make QPS series electronics the hassle-free solution for sound systems and permanent installation applications.



### HD DESIGNED DRIVING POWER

Our HD amplifier technology features a very efficient power section with great care of the power output musicality, maintaining a natural and clear sound at all frequencies, with smooth highs and a tight, high-impact low end. The power supply rails continuously track the input signal for remarkable signal purity while preserving the high efficiency of the Class-D design. QPS amplifiers are bridgeable and maintain high reliability with complex loads as low as 2 ohms nominal.

- 20 ÷ 20000 Hz frequency range
- Fast response and low distortion
- Parallel and bridge modes
- Extensive protection circuits
- Variable speed cooling system
- Signal, clip, fault led indicators
- XLR input connectors
- SPEAKON output connectors
- Limiter on each channel

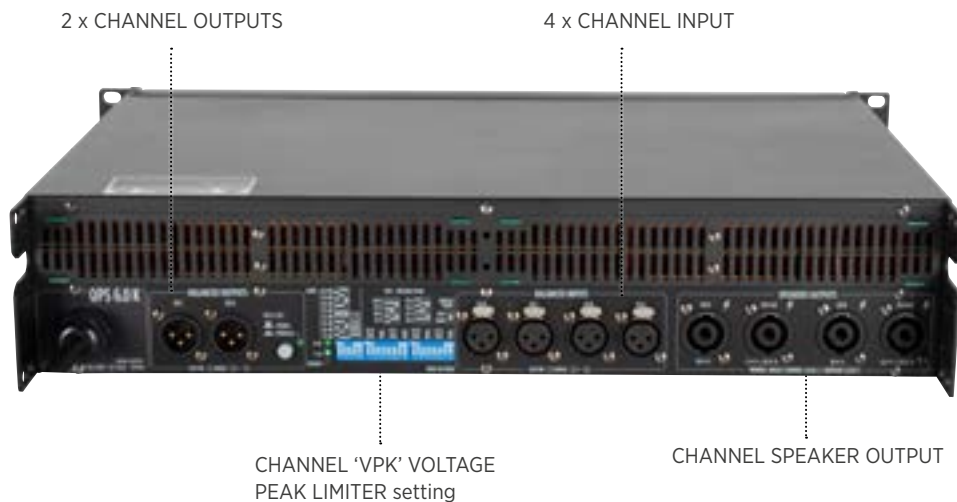





## SPECIFICATIONS

### QPS 10K

p.n. 12100057 (220-240V) - 12100058 (100-120V)

### QPS 6K

p.n. 12100055 (220-240V) - 12100056 (100-120V)

#### Amplifier specifications

Amplifier Class:	HD	HD
Output power:	4 x 2500 W @ 2 ohm 4 x 2200 W @ 4 ohm 4 x 1400 W @ 8 ohm 2 x 5000 W @ 4 ohm (bridge) 2 x 4400 W @ 8 ohm (bridge)	4 x 1500 W @ 2 ohm 4 x 1300 W @ 4 ohm 4 x 700 W @ 8 ohm 2 x 3000 W @ 4 ohm (bridge) 2 x 2600 W @ 8 ohm (bridge)
Frequency Response (-3dB):	20 Hz ÷ 20000 Hz	20 Hz ÷ 20000 Hz
SNR Analog inputs ("A" weighted):	>110 dB	>110 dB
Crosstalk:	<70 dB	<70 dB
Distortion (THD+N) @ 1 kHz nominal power:	<0.05 %	<0.05 %

#### Input section

Total number of inputs:	4	4
Balanced:	4	4
Mono:	4	4
Line inputs:	4	4
Line connectors:	XLR	XLR

#### Output section

Signal output number:	2	2
Signal output connectors:	XLR	XLR
Power output connectors:	Speakon	Speakon

#### Configuration and control

Configuration:	DIP switch, Front panel	DIP switch, Front panel
----------------	-------------------------	-------------------------

#### Protections

Protections:	Forced cooling   Short circuit   Thermal   DC   Fuses   VHF (Very High Frequencies)	Forced cooling   Short circuit   Thermal   DC   Fuses   VHF (Very High Frequencies)
--------------	---	---

#### Power requirement

Operating voltage:	220-240/115 V- 50/60Hz	220-240/115 V- 50/60Hz
Power consumption:	1900 W	1400 W

#### Standard compliance

Safety agency:	CE compliant	CE compliant
----------------	--------------	--------------

#### Physical specifications

Cabinet/Case Material:	Metal	Metal
Handles:	Metal handles included in the front panel	Metal handles included in the front panel
Color:	Black - RAL 9005	Black - RAL 9005
Rack mounting:	19", 2U	19", 2U
Dimensions (H x W x D):	3.46"x 19.02"x 15.71"   88 x 483 x 399 mm	3.46"x 19.02"x 15.71"   88 x 483 x 399 mm
Weight:	31.31 lbs   14.2 kg	30.2 lbs   13.7 kg

# IPS AMPLIFIERS

## IPS SERIES

TWO CHANNELS PROFESSIONAL  
POWER AMPLIFIER

IPS two rack units are high-performance, versatile power amplifiers for install applications, using sophisticated Class-H topology for two single-channel outputs, two parallel outputs or a single-channel bridge operativity in three power options 2 x 2600 W (IPS 5.0K), 2 x 1250 W (IPS 2.5K), 2 x 750 W (IPS 1.5K) at 4 ohms. High quality, low distortion audio output, flawless reliability and safety, industry-standard speakON connectors, and binding post terminals make IPS series electronics the hassle-free solution for sound systems and permanent installation applications. It features independent gain control, signal/clip and fault indicators, stereo XLR input and output link, stereo / parallel / bridge switch, SPEAKON, and binding post output connectors. Moreover, it is protected against short circuits. Thanks to its high-efficiency heat sinks and variable-speed fans, IPS Series can withstand the hardest heat conditions ensuring great reliability.



### THE ADVANTAGE OF CLASS H

Class-H amplifiers modulate the supply voltage to the amplifier output devices so that it is never higher than necessary to support the signal swing. This reduces dissipation across the output devices connected to that supply and allows the amplifier to operate with an optimized efficiency regardless of output power level. Up to full power, a class-H design will require less energy than a pure class AB design and is better suited for high-power applications.

- 20 ÷ 22000 Hz frequency range
- Fast response and low distortion
- Stereo, parallel, bridge modes
- Extensive protection circuits
- Variable speed cooling system
- Signal, clip, fault led indicators
- XLR input connectors
- speakON and binding post output connectors
- Limiter on each channel

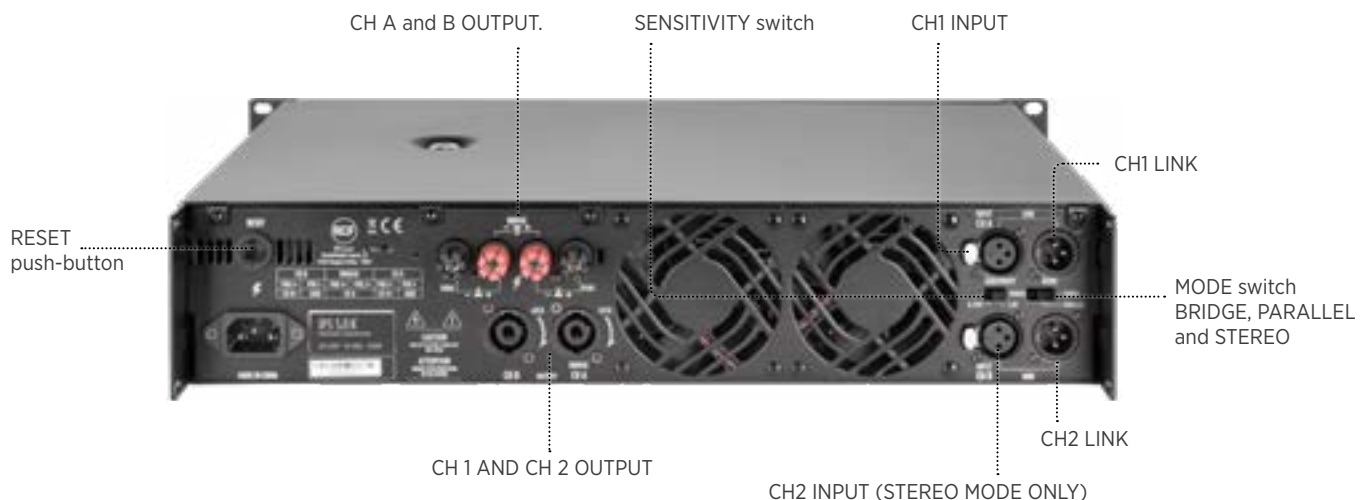



## SPECIFICATIONS

### IPS 5.0K

p.n. 12100061 (220-240V)  
p.n. 12100062 (100-120V)

### IPS 2.5K

p.n. 12100059 (220-240V)  
p.n. 12100060 (100-120V)

### IPS 1.5K

p.n. 12100065 (220-240V)  
p.n. 12100066 (100-120V)

#### Amplifier specifications

Amplifier Class:	H	H	H
Output power:	2 x 2600 W @ 4 ohm 2 x 1500 W @ 8 ohm 1 x 5200 W @ 8 ohm (bridge)	2 x 1250 W @ 4 ohm 2 x 800 W @ 8 ohm 1 x 2500 W @ 8 ohm (bridge)	2 x 750 W @ 4 ohm 2 x 500 W @ 8 ohm 1 x 1500 W @ 8 ohm (bridge)
Frequency Response (-3dB):	20 Hz ÷ 22000 Hz	20 Hz ÷ 22000 Hz	20 Hz ÷ 22000 Hz
SNR Analog inputs ("A" weighted):	-	-	-
Crosstalk:	<70 dB	<80 dB	<73 dB
Distortion (THD+N) @ 1 kHz nominal power:	<0.04 %	<0.01 %	<0.02 %

#### Input section

Total number of inputs:	2	2	2
Balanced:	2	2	2
Mono:	2	2	2
Line inputs:	2	2	2
Line connectors:	XLR	XLR	XLR

#### Output section

Signal output number:	2	2	2
Signal output connectors:	XLR	XLR	XLR
Power output connectors:	Binding Post, Speakon	Binding Post, Speakon	Binding Post, Speakon

#### Configuration and control

Configuration:	DIP switch, Front panel	DIP switch, Front panel	DIP switch, Front panel
----------------	-------------------------	-------------------------	-------------------------

#### Protections

Protections: Forced cooling | Short circuit | Thermal | DC | Fuses | VHF (Very High Frequencies)

#### Power requirement

Operating voltage:	220-240/115 V~ 50/60Hz	220-240/115 V~ 50/60Hz	220-240/115 V~ 50/60Hz
Power consumption:	1800 W	900 W	600 W

#### Standard compliance

Safety agency:	CE compliant	CE compliant	CE compliant
----------------	--------------	--------------	--------------

#### Physical specifications

Cabinet/Case Material:	Metal	Metal	Metal
Color:	Black - RAL 9005	Black - RAL 9005	Black - RAL 9005
Rack mounting:	19", 2U	19", 2U	19", 2U
Dimensions (H x W x D):	3.46" x 18.98" x 12.8" 88 x 482 x 325 mm	3.46" x 18.98" x 12.8" 88 x 482 x 325 mm	3.46" x 18.98" x 10.39" 88 x 482 x 264 mm
Weight:	47.62 lbs   21.6 kg	24.69 lbs   11.2 kg	23.15 lbs   10.5 kg

# DMA AMPLIFIERS

## DMA 504

### FOUR CHANNELS MATRIX AMPLIFIER

DMA 504 is a four-channel class-D matrix amplifiers equipped with a powerful DSP platform, allowing managing inputs and outputs in terms of routing and equalization (a complete set of processing functions is available, including PEQ, FIR filters, bass enhancement, limiters, compressors and environmental equalization); moreover, dedicated presets for RCF speakers have been implemented to optimize their acoustic performance. It can distribute 4 audio channels to other units through an analogue audio BUS, combining a flexible and scalable multi-room architecture with an easy connection and installation. Its configuration is simple and user friendly and can be carried out through either its front panel controls (with OLED display) or RDNet. Thanks to its installation flexibility, accurate design, and robustness, it is ideal for a wide range of business music and installed sound applications.



- 4 x 500 W Class-D power amplifier
- 20 ÷ 20000 Hz frequency range
- Full on-board processing
- RCF speakers' presets
- Proprietary bass enhancer algorithm
- FiRPHASE linear phase filters
- Flexible and scalable multi-room architecture
- Optional 4 in / 4 out DANTE board
- RDNet ready for networked management
- Remote controls and paging console accessories

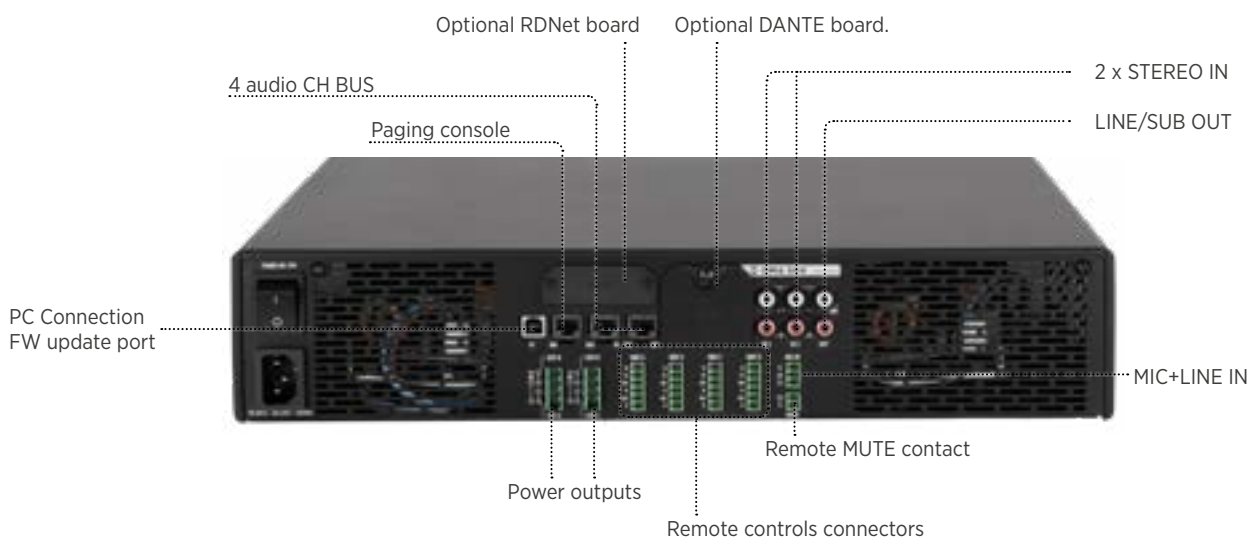



## SPECIFICATIONS

### DMA 504

p.n. 12100035 (EU) - p.n. 12100048 (US) - p.n. 12100049 (UK)

#### Amplifier specifications

Amplifier Class:	D
Output power:	4 x 700 W @ 2.7 ohm 4 x 500 W @ 4 ohm 4 x 300 W @ 8 ohm 2 x 1100 W @ 4 ohm (bridge) 2 x 1000 W @ 8 ohm (bridge)
Output power @ 70 V:	2 x 1000 W @ 70 V
Frequency Response (-3dB):	20 Hz ÷ 20000 Hz
Distortion (THD+N) @ 1 kHz nominal power:	<0.05 %

#### Input section

Total number of inputs:	5
Balanced:	2
Unbalanced:	3
Mono:	2
Stereo:	3
Line inputs:	3
Line connectors:	JACK, Picoflex, RCA
Mic+Line inputs:	1

#### Input section

Mic+Line connectors:	Euroblock
VOX:	Yes
Paging inputs:	1
Paging connectors:	RJ45
Paging command:	Contact
Digital connectors:	Picoflex
General Purpose Inputs (GPI):	1

#### Output section

Signal output number:	1
Signal output connectors:	RCA
Power output connectors:	Euroblock

#### Processing

Processing:	DSP   EQ Filters   FIR   Compressors   Tone controls
High-pass filter:	80 Hz ÷ 200 Hz

#### Configuration and control

Configuration:	Front panel, PC Software
RCF speakers presets:	Yes
Protocols for system integration:	Proprietary
RNet:	Yes

#### Protections

Protections:	Forced cooling   Short circuit   Thermal   DC   Fuses   VHF (Very High Frequencies)
--------------	---

#### Power requirement

Operating voltage:	90-240 V- 50/60Hz
Power consumption:	800 W

#### Standard compliance

Safety agency:	CE compliant
----------------	--------------

#### Physical specifications

Cabinet/Case Material:	Metal
Color:	Black
Rack mounting:	19", 2U
Dimensions (H x W x D):	3.78"x 16.93"x 14.17"   96 x 430 x 360 mm
Weight:	13.67 lbs   6.2 kg

# DMA

## ACCESSORIES

### OPTIONAL RDNet BOARD

The RCF RDNet is the perfect tool to configure and manage DMA units setup in any venues. The software helps to monitor and control all DSP setting and to secure the best performance of the system configuration.

RDNet is a secure and robust management for small, medium, and arena-sized sound systems as well as complex and extended installations. Based on a proprietary network protocol RDNet provides straightforward monitoring and intuitive control of the RCF audio system down to every connected device/object.

### RDNET BOARD DMA

p.n. 12399048



### UNITS CONNECTION

DMA 504 can distribute 4 audio channels, on a dedicated BUS using just 1 CAT 5 CABLE. This allows to increase the installed power and create a multi-room architecture. From the front panel, the first unit shall be configured as MASTER and the others as SLAVE.

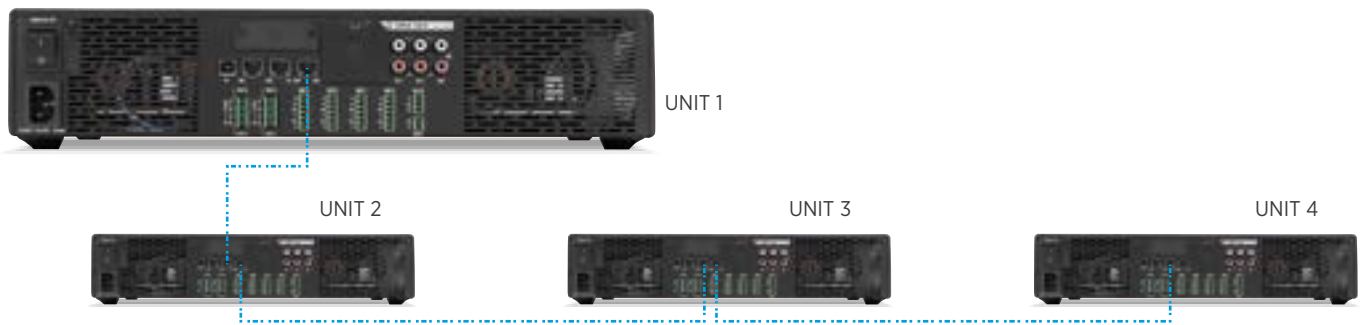

Units connected on the bus can be also DMA 162P. This increase system flexibility and applications range.





### BM 404 - DESKTOP PAGING CONSOLE

BM 404 is a desktop paging console that allows making selective calls to 4 zones. Specifically designed as a complement for Business Music systems, such as DMA amplifiers, the console is made of a shock-resistant polymeric body, fitted with an electret microphone on a 230 mm gooseneck, and a polyurethane foam windscreen. Connect up to 4 consoles on a single chain (interlocked) to each amplifier with a CAT5 cable (included). Dedicated buttons with LEDs allow for microphone activation and zone selection. Chime tone is selectable with a single on/off switch. The RCF BM-404 is ready to use out of the box and does not require any configuration.

- Shock-resistant polymeric body
- High-quality electret microphone with 230 mm long gooseneck
- Zones selection and PTT buttons with LED
- 16ft / 5m connection cable included
- External power supply included



### RC 401 - WALL MOUNT REMOTE CONTROL

1 Volume & 2 Buttons equipped wall mount control panel for DMA 82 and DMA 162 units. Easy connection by CAT5 shielded cable. The controller allows adjusting the output volume, muting it or selecting the desired input program. Available in black or white colour.

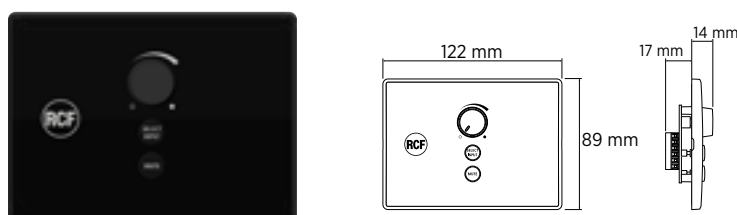

**RC 401 EU B** p.n. 12399051 (EU) Black - RAL 9005  
**RC 401 EU W** p.n. 12399052 (EU) White - RAL 9003

- Works with DMA 82 and DMA 162 units
- Master volume adjustment and mute
- Select input program
- Mute all outputs

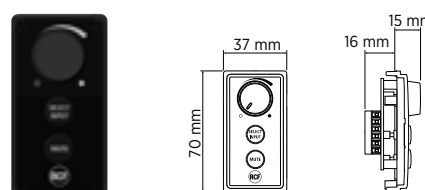

**RC 401 US B** p.n. 12399053 (US) Black - RAL 9005  
**RC 401 US W** p.n. 12399054 (US) White - RAL 9003

# DMA CONNECT

## OPTIONAL BT BOARD DMA

The BT BOARD is an additional board that allows to connect a DMA amplifier to a mobile device using Bluetooth 5.0 technology.

This makes possible to send audio from the mobile device to the amplifier and at the same time control it, in terms of levels and equalization of inputs and outputs.



## BT BOARD DMA

p.n. 12399065



The DMA Connect app for Android and iOS provides wireless control of RCF DMA Series Business Music amplifiers. Thanks to its accurate and user-friendly interface, it gives access to DMA settings such as input and output levels, equalizers, routing, speaker presets selection, device information, and real-time VU-meters. Advanced settings for expert users are also available together with many useful features, including customizable names for input, outputs, and devices.

The app is available as a free download on Apple Store and Google Play store.

It shall be used in combination with BT BOARD DMA, the additional board that connects DMA amplifiers to mobile devices over Bluetooth, allowing audio streaming and control.

DMA Connect offers a complete set of configuration functions and real-time information:

- input settings (level, mute, 3-band equalizer)
- output settings (level, mute, bass-enhancer, routing, speakers' preset selection)
- global mute
- output signals graphic VU-Meters
- device information
- customizable device, input and outputs names
- advanced input management for more skilled users
- BT BOARD DMA firmware update

*iOS and App Store are service marks of Apple Inc.*

*Android and Google Play are trademarks of Google Inc.*

## VU-Meters

It is possible to MUTE each channel, or both using the MUTE ALL button

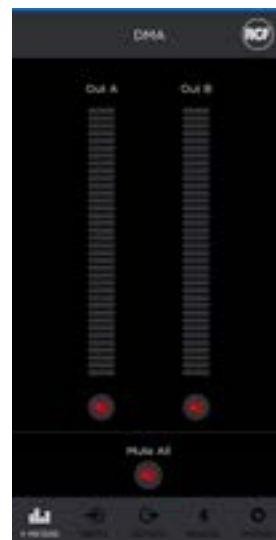
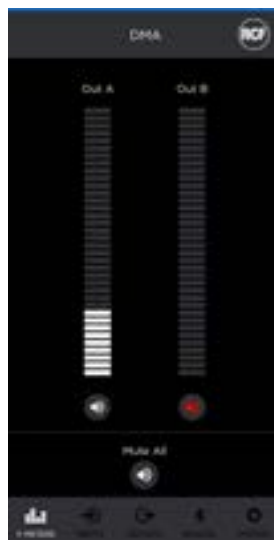
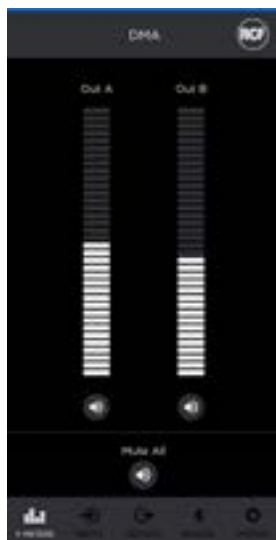





## INPUTS

In the INPUTS screen, all available inputs can be selected and processed in terms of:

- Level
- Three band equalizer

INPUTS can be scrolled using the navigation arrows in the upper left area of the screen.



## OUTPUTS

In the OUTPUTS screen, available outputs can be managed in terms of:

- Level
- Speaker Preset (password needed)
- Bass Enhancer activation
- Input Selection

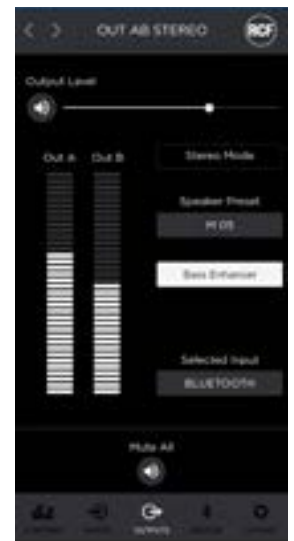

## SYSTEM

In the SYSTEM screen, devices information are shown in a dedicated table, and these commands are available:

- Disconnect
- Advanced (password needed): it opens the list of all inputs, that can be made visible together for advanced settings tasks.
- A Firmware Update button allows to update the BT BOARD DMA firmware (not the amplifier firmware).



# DX ELECTRONICS

## DX 1616

### MATRIX AUDIO PROCESSOR

Combining audio performance, ease of use, and configurable architecture, RCF DX 1616 is a 16 x 16 DSP Audio Matrix Processor with 16 analog I/O, 8 AES I/O, and Dante networking compatibility. Designed around drag-and-drop simplicity, it allows users to quickly configure complex DSP systems faster than ever. The one-unit rack core of the system can be controlled and programmed over Ethernet. DX 1616 connects to a wide range of control interfaces, including its own browser-based control panel; the XTouchApp iOS and Android app; GPIO custom I/O; and third-party control systems.

- Hybrid DSP Architecture
- 48 kHz sampling, 40-bit floating-point engine
- 16 x 16 I/O matrix
- Dante enabled network audio transport
- 8 AES/EBU inputs - 8 AES/EBU outputs
- Ethernet connectivity and control
- 3 ms maximum latency
- Easy-to-use software GUI



## DX 4008

### 4 INPUT - 8 OUTPUT DIGITAL PROCESSOR

The DX 4008 is a complete 4 input - 8 output digital loudspeaker management system designed for the touring or fixed sound installation markets. The absolute latest in available technology is utilized with 32-bit (40-bit extended) floating point processor and high performance 24-bit Analog Converters. The high-bit DSP prevents noise and distortion induced by truncation errors of the commonly used 24-bit fixed-point devices. A complete set of parameters include I/O levels, delay, polarity, 6 bands of

parametric EQ per channel, multiple crossover selections and full function limiters. The DX 4008 can be controlled or configured in real time on the panel or with the intuitive PC GUI accessed via the RS 232 interface. Software upgrade for CPU and DSP via PC keeps the device current with newly developed algorithms and function once available. Multiple setup storage and system security complete this professional package.

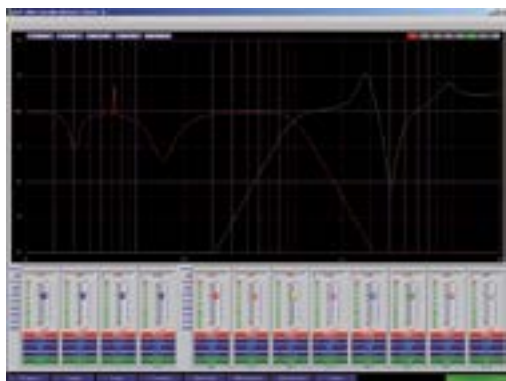

The DX 4008 is shipped with a special PC Graphic User Interface (GUI) application - Xlink that gives the user an option to control the digital processor. The GUI application makes it much easier to control and monitor the device, allowing the user to get the whole picture on one screen. Programs can be recalled and stored from/to PC hard drive, thus expanding the storage to become virtually limitless.



## SPECIFICATIONS

### DX 1616

p.n. 12399033

### DX 4008

p.n. 12135033

#### Audio performance

Frequency Response (-3dB):	20 Hz ÷ 22 kHz	20 Hz ÷ 20 kHz
Crosstalk (on the whole bandwidth):	<-100 dB	<-100 dB
Distortion (THD+N) @ 1 kHz nominal power:	<0.001 %	<0.001 %
Dynamic range:	>110 dB	>115 dB
Common Mode Rejection Ratio (50 Hz to 10 kHz):	>100 dB	>60 dB

#### Digital audio performance

Resolution:	40	40
Sampling rate:	48	96
A/D - D/A converters:	24	24
Propagation delay:	3	3

#### Input section

Total number of inputs:	17	4
Balanced:	17	4
Mono:	16	4
Mic+Line inputs:	16	4
Mic+Line connectors:	Euroblock	XLR
Mic+Line Phantom:	21 V DC - 44 V DC	-
Digital inputs:	1	-
Digital connectors:	RJ45	-
Digital type:	DANTE	-

#### Output section

Signal output number:	16	8
Signal output connectors:	Euroblock	XLR

#### Processing

Processing:	DSP   EQ Filters   Delay   Tone controls	DSP   EQ Filters   Delay   Tone controls
High-pass filter:	20 Hz ÷ 20000 Hz	20 ÷ 20000 Hz
Crossover:	20 ÷ 20000 Hz	20 ÷ 20000 Hz

#### Controls

Configuration:	PC Software	Front panel, PC Software
Number of programs/presets:	70	30
Protocols for system integration:	-	ASCII

#### Protections

Cooling:	Convection/Forced	Convection
Fuses:	Yes	Yes

#### Power requirement

Operating voltage:	90-240 V- 50/60Hz	220-240/115 V- 50/60Hz
Power consumption:	20 W	20 W

#### Standard compliance

Safety agency:	CE compliant	CE compliant
----------------	--------------	--------------

#### Physical specifications

Cabinet/Case Material:	Metal	Metal
Color:	Black	Black
Rack mounting:	19", 1U	19", 1U
Dimensions: H x W x D	1.73" x 19.02" x 9.02"   44 x 483 x 229 mm	1.73" x 19.02" x 7.99"   483x44x229 mm
Weight:	7.3 lb - 3.31 kg	6.53 lb - 2.96 kg

# RdNet

## ELECTRONICS

### RDNET CONTROL 8

#### 8 OUTPUT MASTER UNIT

RdNet Control 8 is a USB/Ethernet interface with 8 RdNet inputs, able to connect up to 256 (8x32) RCF RdNet compatible devices via Ethernet CAT5 cables. With Control 8 and RdNet management software, it's possible to manage and control single or groups of devices with in-depth real-time monitoring. The RdNet Scan function sequentially scans all audio devices connected to Control 8, recognizes, assigns digital address labels, and adds them as objects in the main RdNet window for management, audio routing, monitoring, and adjustments.



p.n. 17170154

- Ethernet (remote control) and USB (direct control) PC connection to RdNet
- Control up to 8 SUB-NETS of up to 32 slave devices
- All devices are cyclically scanned ("polling") 10 times a second
- Auto detect device placement
- Controlling slave devices status and functions
- Monitoring and displaying faults and warnings sent from slave devices
- Storing subnet user filters configuration in a removable memory card





## RDNET CONTROL 2

### 2 OUTPUT MASTER UNIT

RDNet Control 2 is a USB/Ethernet interface with 2 RDNet inputs, able to connect up to 64 (2x32) RCF RDNet compatible devices via Ethernet CAT5 cables. With Control 2 and RDNet management software, it's possible to manage and control single or groups of devices with in-depth real-time monitoring. The RDNet Scan function sequentially scans all audio devices connected to Control 2, recognizes, assigns digital address labels, and adds them as objects in the main RDNet window for management, audio routing, monitoring, and adjustments.



p.n. 17170163

- Real-time USB device monitoring and control
- Auto detect device placement
- Control up to 2 SUB-NETS of up to 32 slave devices
- All devices are cyclically scanned ("polling") 10 times a second
- Connected devices are automatically added to the software synoptic

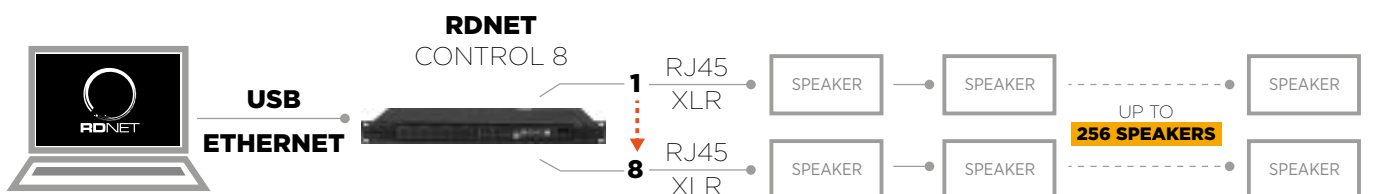
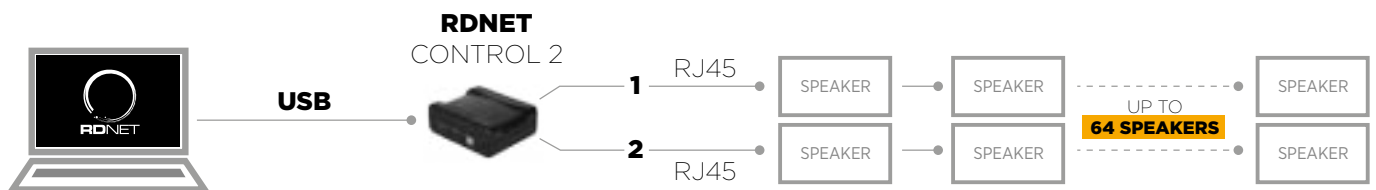

## APPLICATIONS

Sports Facilities and Stadia

Airports, Railways, Metros and Transport Infrastructures

Theaters, Concert Halls and Studios

Hospitals

Shopping Centers and Public Buildings

Schools and Universities

Museums and Exhibition Centers

Hotels and Spa Resorts

Places of Worship

Conference Rooms and Convention Halls

Bars, Pubs and Restaurants

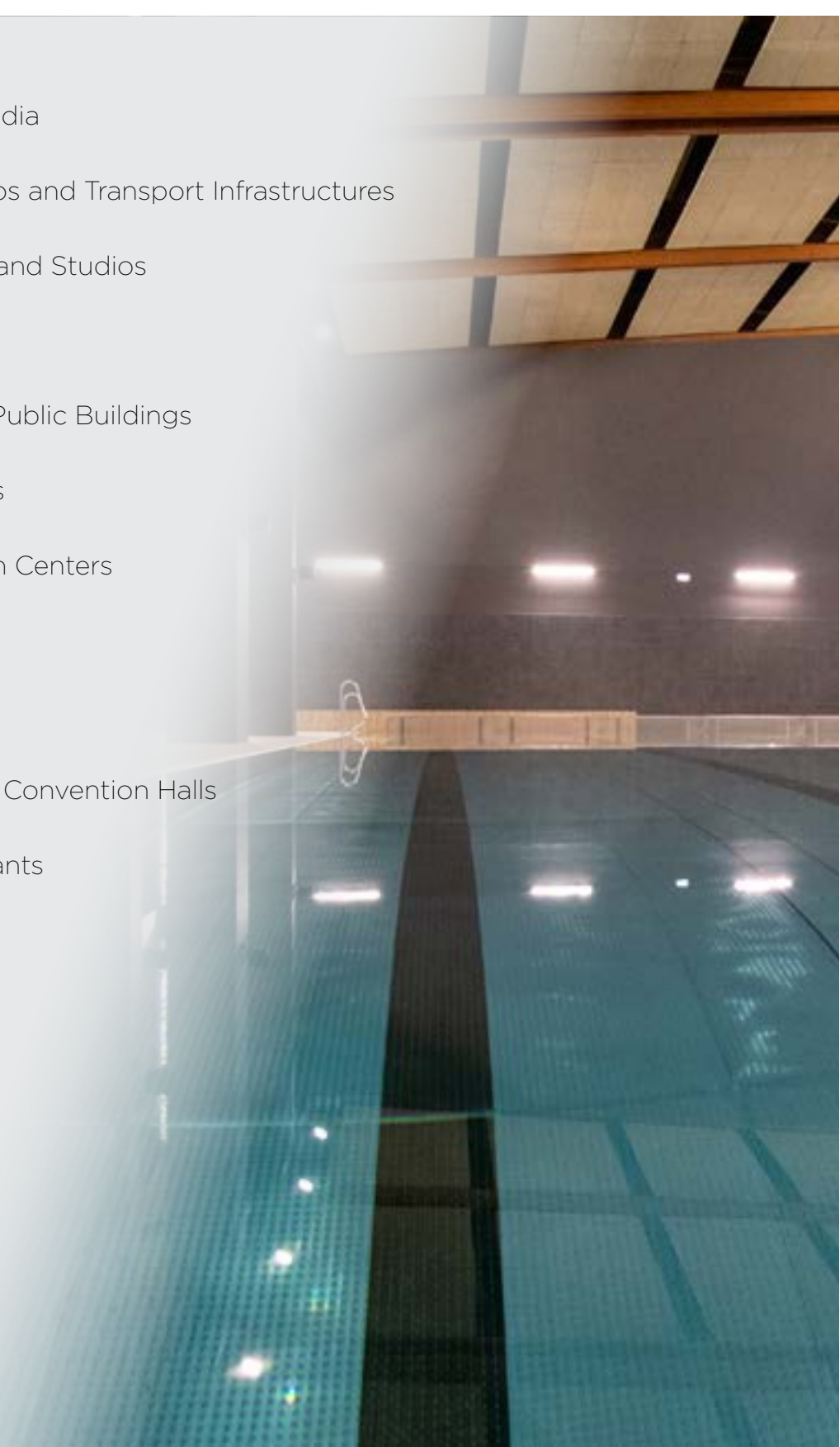





[www.rcf.it](http://www.rcf.it)

HEADQUARTERS:

RCF S.p.A. Italy  
tel. +39 0522 274 411  
e-mail: [info@rcf.it](mailto:info@rcf.it)

RCF UK  
Int. +44 (0) 1702 800846  
e-mail: [info@rcfaudio.co.uk](mailto:info@rcfaudio.co.uk)

RCF France  
tel. +33 6 24 15 81 76  
e-mail: [france@rcf.it](mailto:france@rcf.it)

RCF Germany  
tel. +49 2203 925370  
e-mail: [germany@rcf.it](mailto:germany@rcf.it)

RCF Spain  
tel. +34 91 817 42 66  
e-mail: [info@rcfaudio.es](mailto:info@rcfaudio.es)

RCF Benelux  
tel. +49 (0) 2203 9253724  
e-mail: [benelux@rcf.it](mailto:benelux@rcf.it)

RCF USA Inc.  
tel. +1 732-9026100  
e-mail: [info@rcf-usa.com](mailto:info@rcf-usa.com)