

ø 465 mm

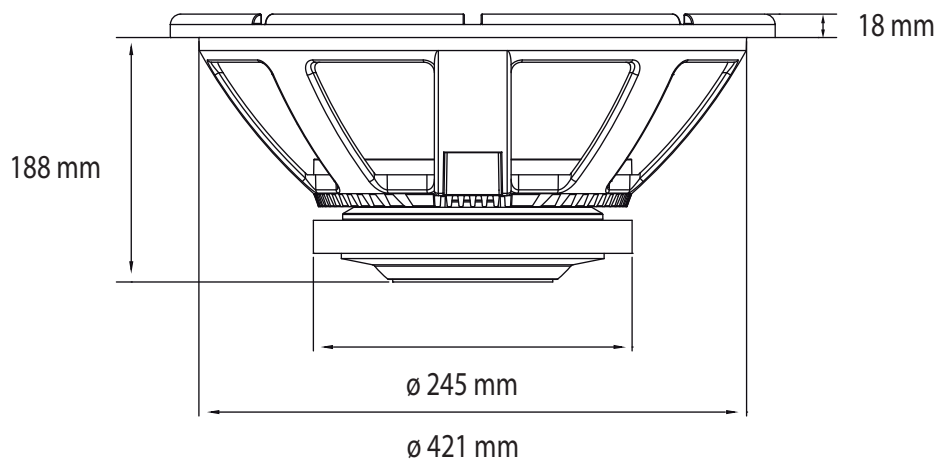

18 mm

188 mm

ø 245 mm

ø 421 mm