

MQ 100L

THREE-WAY COLUMN LOUDSPEAKER

DESCRIPTION

MQ 100L (available in black and white) is a 3 way column loudspeaker providing natural hi-fi delity sound of both speech and music, suitable for sound system having fixed loudspeakers where the environment is acoustically critical or with architectural constraints.

The wide horizontal coverage angle (180°) and the vertical dispersion (60°) allow the correct sound reproduction in a wide space, in order to limit feedback and improve the sound directivity which is important, for instance, in halls having a long reverberation time. The mounting accessories are included. These have been engineered to keep the column as close as possible to the wall and simplify the installation. Its tilt angle can be chosen among 0° - 5° - 10°. The 60° vertical dispersion is asymmetric: it is the difference between 20° upwards and 40° downwards. The vertical dispersion axis is in fact already angled 10° downwards, making it unnecessary to tilt the sound column excessively.



FEATURES

- 2 x 3.5" woofer, 2 x 3.5 midrange and 2 x 0.75 dome tweeter
- Power selectable (100 V): 40 W - 20 W - 10 W - 5 W
- 93 dB sensitivity
- Colour white RAL 9016 and black RAL 9005
- Plastic body, steel grille

TECHNICAL SPECIFICATIONS

Acoustical specifications	Frequency Response (-10dB):	130 Hz ÷ 20000 Hz
	Max SPL @ 1m:	112 dB
	Horizontal coverage angle:	180°
	Vertical coverage angle:	60°
	System Sensitivity:	93 dB
Power section	Nominal Impedance (ohm):	16 ohm
	Power Handling:	80 W RMS
	Peak Power Handling:	320 W PEAK
	Recommended Amplifier:	160 W
	Protections:	PTC on tweeter
	Crossover Frequencies:	2000 Hz
Transducers	Dome Tweeter:	2 x 0.75"
	Midrange:	2 x 3.5"
	Woofers:	2 x 3.5"
Input/Output section	Input connectors:	Euroblock
	Output connectors:	Euroblock
	Constant Voltage Transformer:	100 V
	Power selection 1:	40 W - 250 ohm
	Power selection 2:	20 W - 500 ohm
	Power selection 3:	10 W - 1000 ohm
	Power selection 4:	5 W - 2000 ohm
Standard compliance	CE marking:	Yes
Physical specifications	Cabinet/Case Material:	Plastic
	Hardware:	Wall mount bracket
	Grille:	Steel
	Color:	White - RAL 9016, Black - RAL 9005
Size	Height:	500 mm / 19.69 inches
	Width:	120 mm / 4.72 inches
	Depth:	167 mm / 6.57 inches
	Weight:	2.73 kg / 6.02 lbs
Shipping informations	Package Height:	550 mm / 21.65 inches
	Package Width:	180 mm / 7.09 inches
	Package Depth:	180 mm / 7.09 inches
	Package Weight:	4.8 kg / 10.58 lbs



PART NUMBER

• **13000187**

MQ 100L W

White - RAL 9016

EAN 8024530006570

• **13000186**

MQ 100L B

Black - RAL 9005

EAN 8024530006563

DRAWINGS

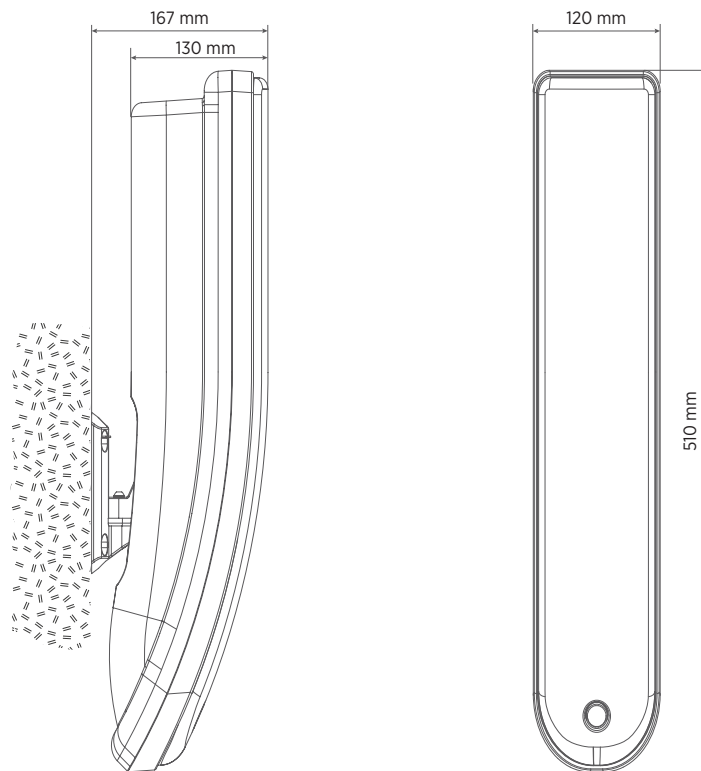

INSTALLATION

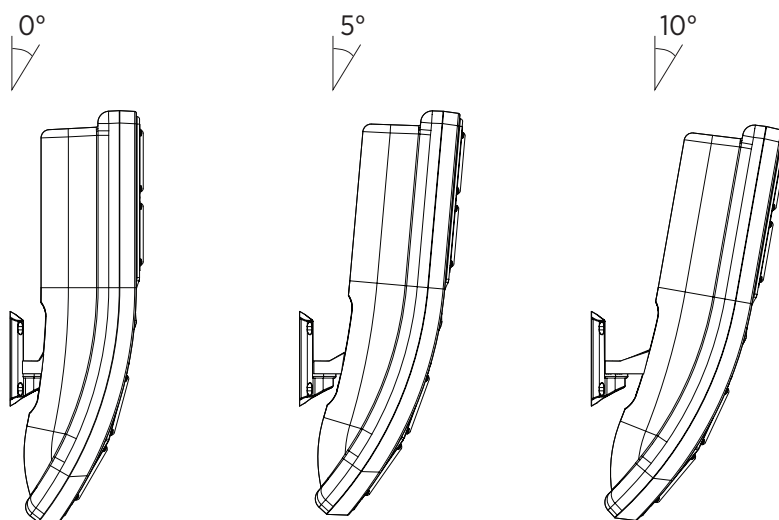

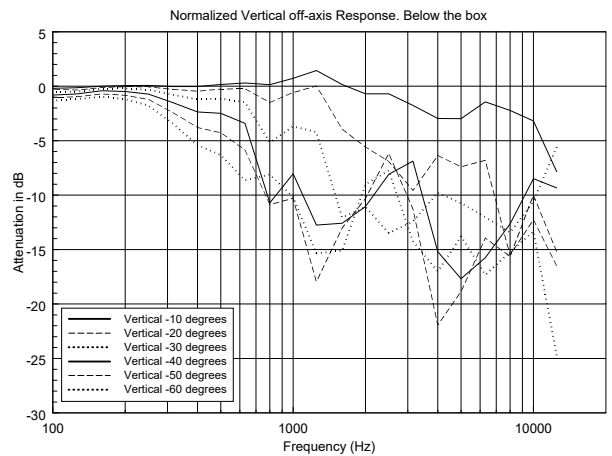
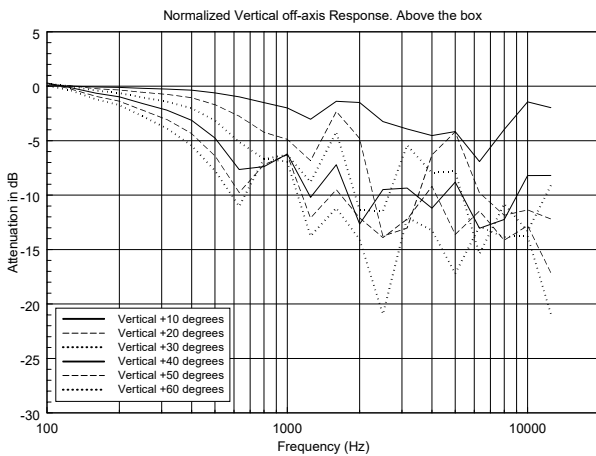
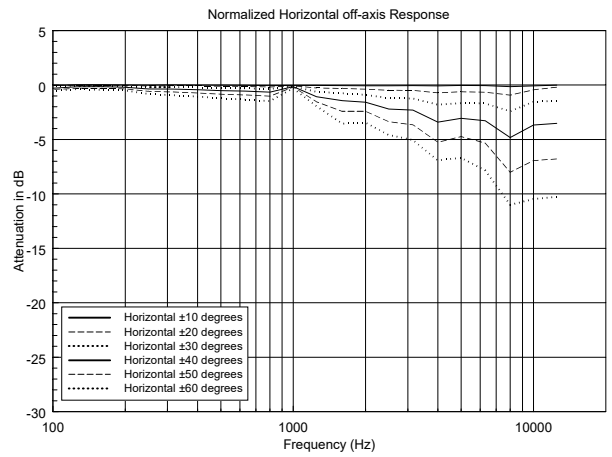
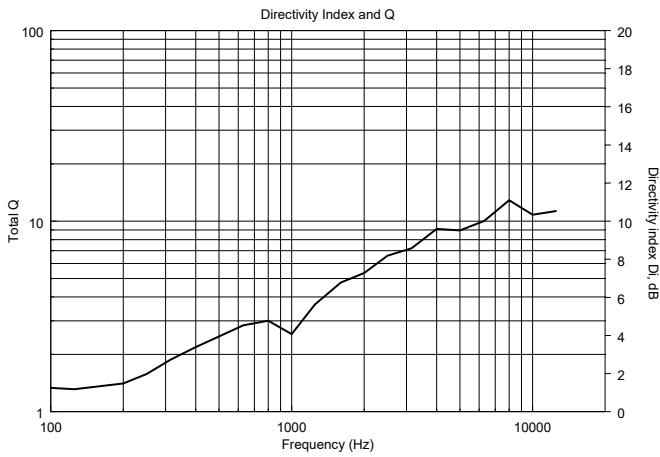
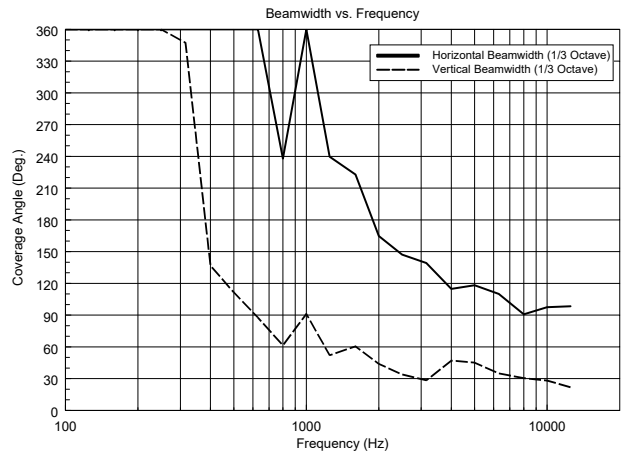
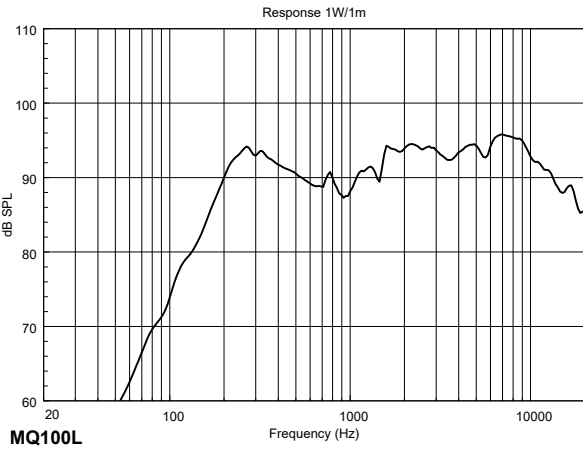

HORIZONTAL 1/3 POLAR PLOT

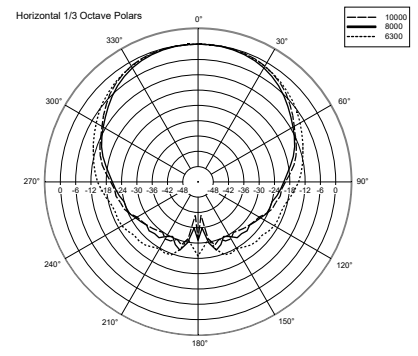
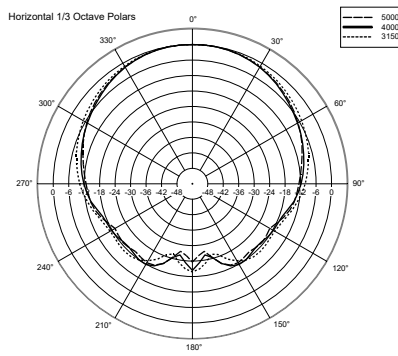
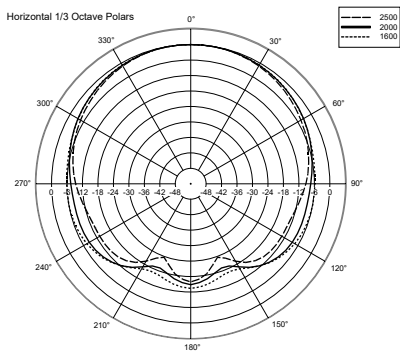
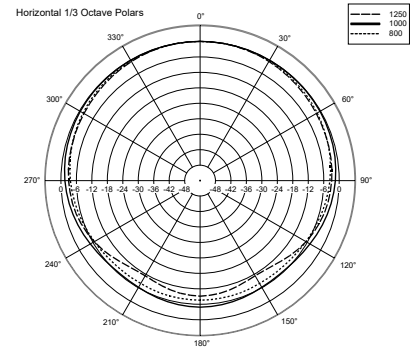
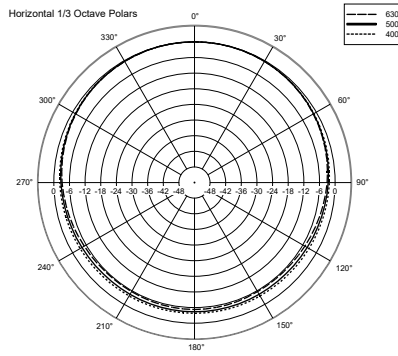
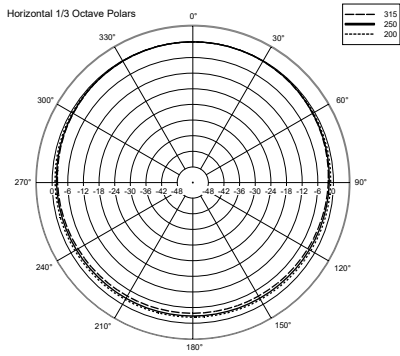

VERTICAL 1/3 POLAR PLOT

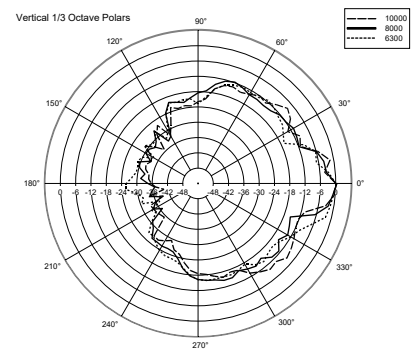
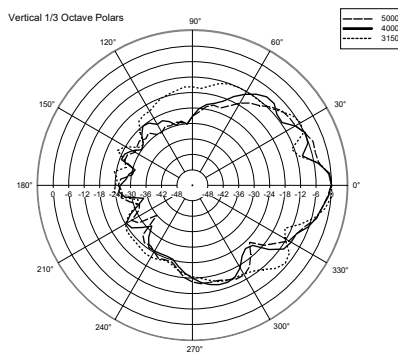
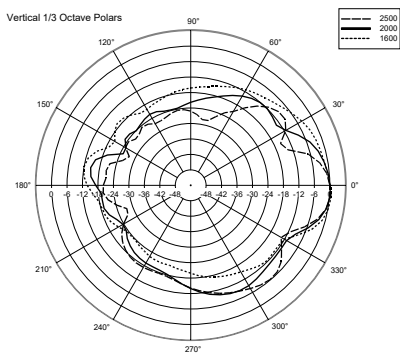
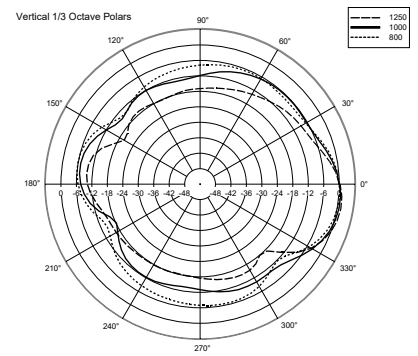
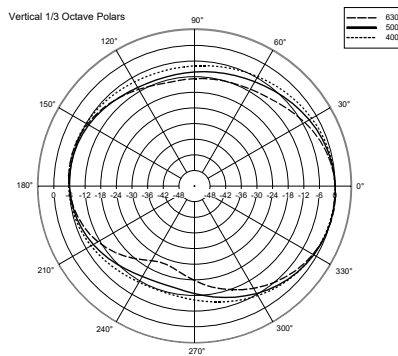
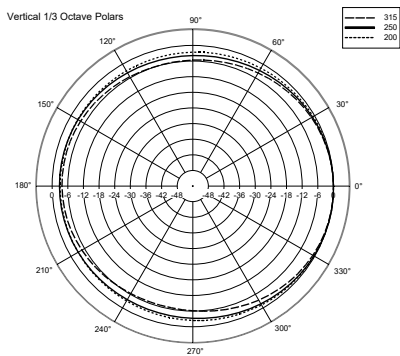

A&E SPECIFICATIONS

The product shall be a 3-way column speaker providing natural high fidelity sound of both speech and music, suitable for sound system having fixed speakers where the environment is acoustically critical or with architectural constraints.

Its design shall be elegant and compact with accurate finishing, suitable for almost any environment, even with architectural constraints.

Its wide horizontal coverage angle (180°) and its vertical dispersion (60°) will allow the correct sound reproduction in a wide space, in order to limit feedback and improve the sound directivity which is important, for instance, in halls having a long reverberation time.

Its mounting accessories shall be included. These shall be engineered to keep the column as close as possible to the wall and simplify its installation. It shall be possible to choose an angle among 0° - 5° - 10°. Its 60° vertical dispersion shall be asymmetric (difference between 20° upwards and 40° downwards), the axis shall be angled 10° downwards, making it unnecessary to tilt the sound column excessively.

It shall include an internal transformer that allows the connection to 100 V constant voltage lines.
