



H-BR 003

PAIR OF HORIZONTAL BRACKETS



Description Pair of brackets for 12" cabinets horizontal wall mounting.

Standard compliance Safety agency CE compliant

Size Weight 4.7 kg / 10.36 lbs

Physical specifications Color Black - RAL 9005, White - RAL 9003

Line Art 2D

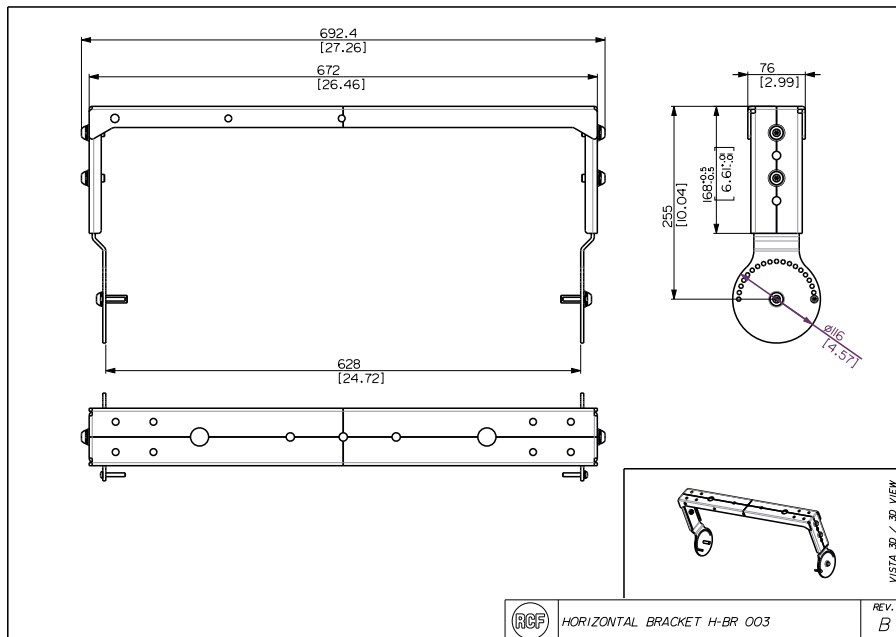

Part Number 13360538 H-BR 003
13360609 H-BR 003 W

Black - RAL 9005 EAN 8024530021337
White - RAL 9003 EAN 8024530021573

Technical Specifications

Products are continually improved. All specifications are therefore subject to change without notice.